

JVC

The Perfect Experience / —

D-ILA® HD Projector

DLA-RS1



The Ultimate HD Viewing Experience



REFERENCE **SERIES**

D-ILA®

Full HD
1920x1080

Experience the awesome quality of full HD images and 15000:1 contrast

REFERENCE *SERIES*

Visual perfection for the most discerning customer

A select line of home entertainment display products that embody the finest technology from JVC.

With a goal of providing total satisfaction and the optimum high definition visual experience, Reference Series products offer industry leading original JVC technology, uncompromised image quality, high end premium styling and are designed for custom integration.

REFERENCE SERIES

JVC

Compact, all-in-one projector with full HD resolution brings awe-inspiring, cinema quality images to your home theater.

D-ILA[®]

SUPERB CINEMA QUALITY PICTURE

■ Newly-developed 0.7-inch full HD D-ILA device

The application of a new liquid crystal material and new orientation technology has made it possible to optimize the liquid crystal thickness from 3.2 microns to 2.3 microns. This reduces the light loss from the LCD layer itself and greatly enhances compensation precision. These new technologies have also made it possible for the device to achieve ultra-high contrast of 20,000:1 and have improved response speed from 8 msec to 4 msec.



Newly-developed 0.7-inch full HD D-ILA device

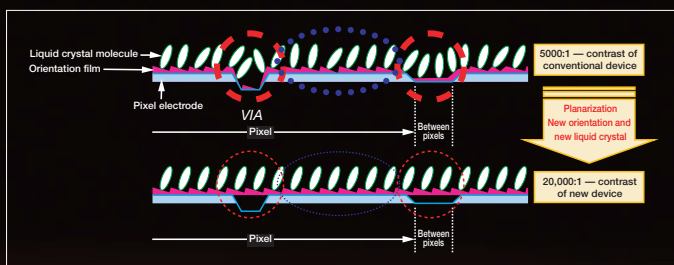

VXP™ technologies

● TruMotionHD™

Fully compatible with HD signals (1080i), TruMotionHD™ progressive conversion technology outputs high quality 1080p images.

● FineEdge™

FineEdge™ contour compensation technology reduces the "jaggies", creating smoother contours and maintaining overall image sharpness.

● FidelityEngine™

Designed to maximize image details, FidelityEngine™ technology enhances details while suppressing noise, making it ideal for images with low resolution.

● RealityExpansion™

With full high-precision 10-bit video processing architecture, RealityExpansion™ technology can sample Y:Cb:Cr=4:2:2 video signals at up to 4:4:4. By eliminating artifacts and ensuring smooth, natural images, it provides signal processing capability equivalent to that required for a broadcast master.



*VXP and Visual Excellence Processing are trademarks of Gennum Corporation.

■ New WireGrid optical engine

JVC's new optical engine uses our advanced WireGrid inorganic reflective polarized light plate made of aluminum ribs on a glass substrate. These ribs are formed with widths of 10 nanometers and a pitch (distance from line to line) of more than 100 nanometers. The WireGrid has a lower angle dependency for polarized light, effectively minimizing any leakage of light to the lens when the image is black.

● WireGrid operation

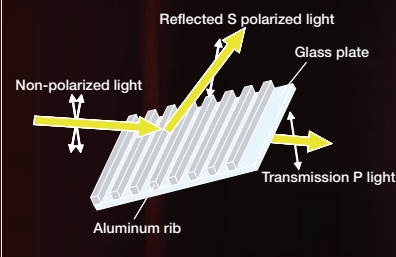

In combination with the newly developed D-ILA device, this new optical engine helps achieve native contrast of 15,000:1.

■ Native 15,000:1 high contrast ratio without iris adjustment

By combining our newly developed 0.7-inch full HD (H 1920 x V 1080 pixels) D-ILA device with a new optical engine, we have achieved native contrast of 15,000:1 without iris adjustment. This allows reproduction of real black and ensures that details and depth in dark scenes are expressed clearly and vividly.



Image with conventional projector



Image with native contrast of 15,000:1

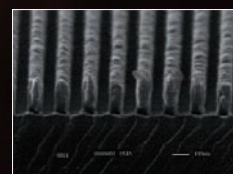
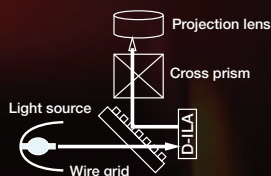

EASY OPERATIONS

■ Easy-to-use self-illuminated remote control

Illuminated buttons make it easy to operate your projector even in a dark room. To make things even simpler, direct keys are provided for frequently used functions such as contrast and brightness, as well as input switching.



■ High-performance video processor

The heart of the video circuit is the high-performance Gennum "GF9351" processor. Incorporating four VXP™ technologies and high-precision scaling, this processor further enhances image quality, ensuring high-quality picture reproduction.



■ Image adjustment menu

To suit your video sources and viewing preferences, a convenient image adjustment menu allows you to adjust a variety of image parameters, including color temperature and gamma adjustment.

With ultra-high native contrast ratio of 15,000:1, full HD resolution and brilliant color reproduction, the JVC Professional DLA-RS1 projector produces vivid, cinema quality images with real blacks. An all in one design and easy, flexible set up, make the DLA-RS1 the ideal projector for true home theater image perfection.

It's never been easier or more affordable to enjoy movies with beautiful high-definition images on the big screen.

FLEXIBLE INSTALLATION

High-performance 2x zoom lens

The projection lens used in this projector is a large aperture, all-glass, 13-group, 16-element device manufactured by legendary lens-maker Fujinon. The superior optical performance reduces chromatic aberration to enable accurate reproduction of properly focused high-resolution images. Thanks to the high-performance 2x zoom, clear, dynamic large screen images can be enjoyed even in smaller rooms where it's difficult to get enough distance from the screen.



Front ventilation

To maximize the projector's performance and installation flexibility, front ventilation has been incorporated. Easy connections are made from the rear of the unit. This simple design allows the projector to be installed just about anywhere even in locations where ceiling installation is not possible. For added convenience, the lamp can be accessed and replaced from the side.



Cover for lamp exchange

Lens shift function

(V: 80%, H: 34%)

With an expansive lens shift range of 80% vertically and 34% horizontally, this projector offers a remarkable degree of flexibility when it comes to installation environment and ease of installation.

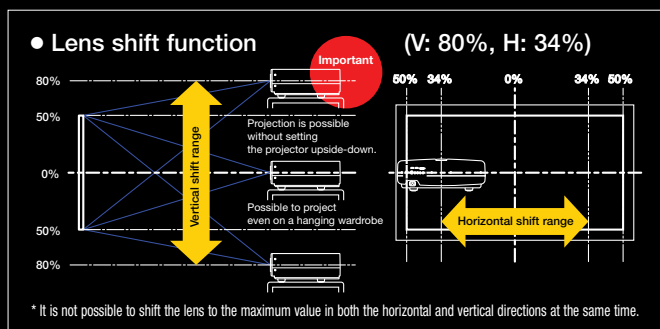

Lens shift correlation table

Horizontal lens shift	0%	5%	10%	15%	20%	25%	30%	34%
Vertical lens shift	80%	73.5%	65.9%	57%	46.5%	33.8%	17.6%	0%

*The above figures are design values.

Advantages of 3-chip D-ILA technology

JVC's original D-ILA technology

Three D-ILA chips for smooth, flicker-free high-resolution images

JVC's original 3-chip D-ILA (Direct Drive Image Light Amplifier) technology produces clear, natural images without the annoying flicker or "rainbow effect" that plagues single panel projectors. Images are as smooth as film, boasting incredible detail.

Cinema-quality picture with no visible grid

There is no visible grid or "screen door effect" with JVC's D-ILA so you can enjoy the beauty of cinema quality resolution.

Enlarged picture of the D-ILA imaging device

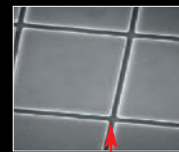

Fine pixel gap of 0.5 μm

Professional-standard gray scale reproduction

JVC's D-ILA exclusive technology produces highly accurate gradations with low noise. The quality of gray-scale reproduction is further enhanced by high 15,000:1 contrast that ensures high-precision, high-quality pictures without black paint even when the scene on screen is dark.

Superior color reproduction

JVC's unique optical engine produces rich, natural colors with smooth gradations and low noise. As the D-ILA's liquid crystals are aligned vertically, the pixels are "normally black" when no voltage is applied. As a result, D-ILA technology reproduces blacks that are truly black. It also offers a uniform response, irrespective of brightness, displaying a wide range of intermediate tones.

DLA-RS1 Color Coordinates

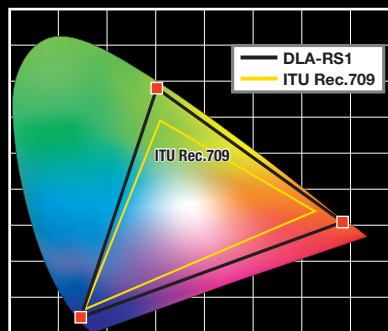

Comparison of gradation characteristics



D-ILA

(accurate colors with absolute white and black)



Conventional projector (bluish white and reddish black)

Specifications

Image Device	3-chip D-ILA* (0.7-inch diagonal)	
Aspect Ratio	16:9	
Throw Distance (16:9)	5.90 ft to 40.02 ft (1.8 m to 12.2 m)	
Screen Size (16:9)	60" to 200" diagonal	
Resolution	1920 x 1080 pixels (16:9) x 3 chips; Total resolution: 6,220,800 pixels	
Projection Lens	2.0x zoom lens (1.4:1 – 2.8:1) Manual zoom/focus Lens shift (V) ±80%, (H) ±34%	
Brightness	700 lumens	
Input Signals	Analog	480i/p, 576i/p, 720p 60/50, 1080i 60/50
	Digital	480i/p, 576i/p, 720p 60/50, 1080i 60/50, 1080 24p/60p/50p, VGA 60Hz
Lamp	200 W HSCR (BHL5009-S)	
Contrast Ratio	15,000:1 (without iris)	
Major menu adjustments	Gamma Control	Normal, A, B, C
	Image Profile	Cinema, Natural, Dynamic, User1, User2, User3
	Lamp Power	Normal (170W), High (200W) * Changing the lamp power will not change the lamp time (lamp life).
	Color Temperature	Low, Middle, High, User 1, User 2
Noise Level	25 dB (Normal mode)	
TERMINALS		
Input	S-Video x 1 (Mini DIN 4-pin), Composite x 1 (RCA), Component x 1 (RCA x 3, in common use with RGB), HDMI x 2	
Serial Control	RS-232C x 1 (D-sub 9-pin)	
GENERAL		
Power Requirement	110 V – 240 V AC, 50/60 Hz	
Power Consumption	280W (Standby mode: 2.7W)	
Dimensions (WHD) (Excluding lens and protrusions)	18" x 7-1/4" x 17-9/16" (455 x 172.5 x 418.5 mm)	
Weight	25.6 lbs. (11.6 kg)	

Throw Distance vs. Screen Size

Diagonal	Screen Size		Throw Distance			
	in.	mm	Wide		Tele	
60	1328	4.36	1.78	5.84	3.63	18.47
70	1549	5.08	2.09	6.86	4.24	13.91
80	1771	5.81	2.40	7.87	4.86	15.94
90	1992	6.53	2.71	8.89	5.47	17.94
100	2214	7.26	3.01	9.87	6.08	19.94
110	2435	7.99	3.32	10.89	6.70	21.98
120	2656	8.71	3.63	11.91	7.31	23.98
130	2878	9.44	3.93	12.89	7.93	26.01
140	3099	10.16	4.24	13.91	8.54	28.01
150	3320	10.89	4.55	14.92	9.16	30.04
160	3542	11.62	4.86	15.94	9.77	32.05
170	3763	12.34	5.16	16.92	10.38	34.05
180	3984	13.07	5.47	17.94	11.00	36.08
190	4206	13.80	5.78	18.96	11.61	38.08
200	4427	14.53	6.08	18.84	12.23	40.11

The above values are approx.

Provided Accessories



- Remote control
- Two AAA batteries
- Power cord
- Instruction manual, warranty card and other printed materials

Options

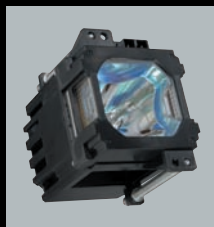

Spare lamp
BHL5009-S

Dimensions

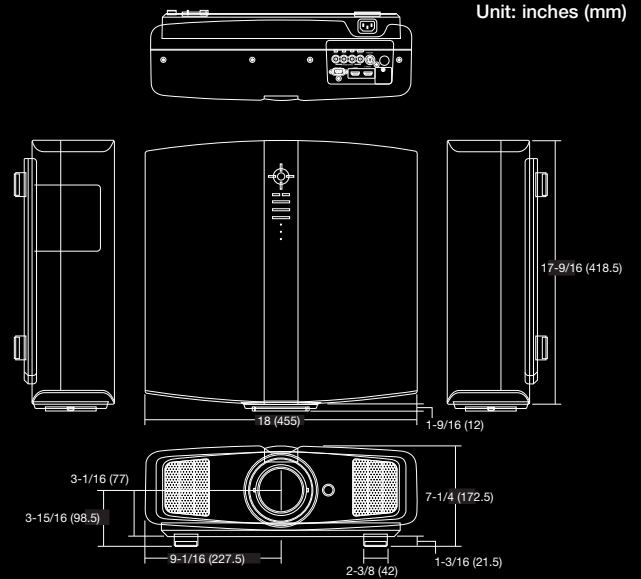

Connectors



Controls



JVC®

DISTRIBUTED BY

Design and specifications subject to change without notice.
D-ILA is a registered trademark of Victor Company of Japan, Limited.
All brand or product names may be trademarks and/or registered trademarks of their respective owners.
Any rights not expressly granted herein are reserved.
All photographs and screenshots in this catalog are simulated.
Copyright © 2007, Victor Company of Japan, Limited (JVC). All Rights Reserved.



JVC PROFESSIONAL PRODUCTS COMPANY
DIVISION OF JVC AMERICAS CORP.
1700 Valley Road, Wayne, N.J. 07470
TEL: (973) 317-5000, (800) 582-5825 FAX: (973) 317-5030
Internet Web Site <http://www.jvc.com/pro>
E-mail: proinfo@jvc.com

JVC CANADA INC.
21 Finchdene Square, Scarborough, Ontario M1X 1A7
TEL: (416) 293-1311 FAX: (416) 293-8208
Internet Web Site <http://www.jvc.ca/en/pro/>

Printed in Japan
DLAKN-1206 (U)

JVC is the trademark or registered trademark of Victor Company of Japan, Limited.