

# JVC®

## DV VIDEO CASSETTE RECORDER

# BR-DV6000U

## INSTRUCTION MANUAL

# Mini DV

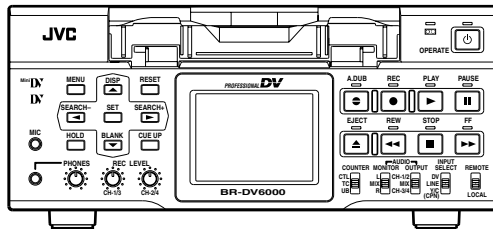

Thank you for purchasing this JVC product. Before operating this unit, please read the instructions carefully to ensure the best possible performance.

### For Customer Use:

Enter below the Serial No. which is located on the rear of cabinet. Retain this information for future reference.

Model No. BR-DV6000U

Serial No. \_\_\_\_\_

# IMPORTANT SAFEGUARDS

1. Read all of these instructions.
  2. Save these instructions for later use.
  3. All warnings on the product and in the operating instructions should be adhered to.
  4. Unplug this appliance system from the wall outlet before cleaning. Do not use liquid cleaners or aerosol cleaners. Use a damp cloth for cleaning.
  5. Do not use attachments not recommended by the appliance manufacturer as they may cause hazards.
  6. Do not use this appliance near water – for example, near a bathtub, washbowl, kitchen sink, or laundry tub, in a wet basement, or near a swimming pool, etc.
  7. Do not place this appliance on an unstable cart, stand, or table. The appliance may fall, causing serious injury to a child or adult, and serious damage to the appliance.  
Use only with a cart or stand recommended by the manufacturer, or sold with the appliance.  
Wall or shelf mounting should follow the manufacturer's instructions, and should use a mounting kit approved by the manufacturer.  
An appliance and cart combination should be moved with care. Quick stops, excessive force, and uneven surfaces may cause the appliance and cart combination to overturn.
- PORTABLE CART WARNING  
(symbol provided by RETAC)
- 
- S3125A
8. Slots and openings in the cabinet and the back or bottom are provided for ventilation, and to insure reliable operation of the appliance and to protect it from overheating, these openings must not be blocked or covered. The openings should never be blocked by placing the appliance on a bed, sofa, rug, or other similar surface. This appliance should never be placed near or over a radiator or heat register. This appliance should not be placed in a built-in installation such as a bookcase unless proper ventilation is provided.
  9. This appliance should be operated only from the type of power source indicated on the marking label. If you are not sure of the type of power supplied to your home, consult your dealer or local power company. For appliance designed to operate from battery power, refer to the operating instructions.
  10. This appliance system is equipped with a 3-wire grounding type plug (a plug having a third (grounding) pin). This plug will only fit into a grounding-type power outlet. This is a safety feature. If you are unable to insert the plug into the outlet, contact your electrician to replace your obsolete outlet. Do not defeat the safety purpose of the grounding plug.
  11. For added protection for this product during a lightning storm, or when it is left unattended and unused for long periods of time, unplug it from the wall outlet and disconnect the antenna or cable system. This will prevent damage to the product due to lightning and power-line surges.
  12. Do not allow anything to rest on the power cord. Do not locate this appliance where the cord will be abused by persons walking on it.
  13. Follow all warnings and instructions marked on the appliance.
  14. Do not overload wall outlets and extension cords as this can result in fire or electric shock.
  15. Never push objects of any kind into this appliance through cabinet slots as they may touch dangerous voltage points or short out parts that could result in a fire or electric shock. Never spill liquid of any kind on the appliance.
  16. Do not attempt to service this appliance yourself as opening or removing covers may expose you to dangerous voltage or other hazards. Refer all servicing to qualified service personnel.
  17. Unplug this appliance from the wall outlet and refer servicing to qualified service personnel under the following conditions:
    - a. When the power cord or plug is damaged or frayed.
    - b. If liquid has been spilled into the appliance.
    - c. If the appliance has been exposed to rain or water.
    - d. If the appliance does not operate normally by following the operating instructions. Adjust only those controls that are covered by the operating instructions as improper adjustment of other controls may result in damage and will often require extensive work by a qualified technician to restore the appliance to normal operation.
    - e. If the appliance has been dropped or the cabinet has been damaged.
    - f. When the appliance exhibits a distinct change in performance – this indicates a need for service.
  18. When replacement parts are required, be sure the service technician has used replacement parts specified by the manufacturer that have the same characteristics as the original part. Unauthorized substitutions may result in fire, electric shock, or other hazards.
  19. Upon completion of any service or repairs to this appliance, ask the service technician to perform routine safety checks to determine that the appliance is in safe operating condition.

# SAFETY PRECAUTIONS



## CAUTION

RISK OF ELECTRIC SHOCK  
DO NOT OPEN



CAUTION: TO REDUCE THE RISK OF ELECTRIC SHOCK,  
DO NOT REMOVE COVER (OR BACK).  
NO USER-SERVICEABLE PARTS INSIDE.  
REFER SERVICING TO QUALIFIED SERVICE PERSONNEL



The lightning flash with arrowhead symbol, within an equilateral triangle, is intended to alert the user to the presence of uninsulated "dangerous voltage" within the product's enclosure that may be of sufficient magnitude to constitute a risk of electric shock to persons.



The exclamation point within an equilateral triangle is intended to alert the user to the presence of important operating and maintenance (servicing) instructions in the literature accompanying the appliance.

**WARNING:**  
TO REDUCE THE RISK OF FIRE OR  
ELECTRIC SHOCK, DO NOT EXPOSE THIS  
APPLIANCE TO RAIN OR MOISTURE.

This unit should be used with 120 V AC only.

### CAUTION:

To prevent electric shocks and fire hazards, DO NOT use any other power source.

### NOTE:

The rating plate (serial number plate) is on the rear of the unit.

## INFORMATION

This equipment has been tested and found to comply with the limits for a Class B digital device, pursuant to Part 15 of the FCC Rules. These limits are designed to provide reasonable protection against harmful interference in a residential installation. This equipment generates, uses, and can radiate radio frequency energy and, if not installed and used in accordance with the instructions, may cause harmful interference to radio communications. However, there is no guarantee that interference will not occur in a particular installation. If this equipment does cause harmful interference to radio or television reception, which can be determined by turning the equipment off and on, the user is encouraged to try to correct the interference by one or more of the following measures:

- Reorient or relocate the receiving antenna.
- Increase the separation between the equipment and receiver.
- Connect the equipment into an outlet on a circuit different from that to which the receiver is connected.
- Consult the dealer or an experienced radio/TV technician for help.

## CAUTION

CHANGES OR MODIFICATIONS NOT APPROVED  
BY JVC COULD VOID USER'S AUTHORITY TO  
OPERATE THE EQUIPMENT.

THIS DEVICE COMPLIES WITH PART 15 OF THE  
FCC RULES. OPERATION IS SUBJECT TO THE  
FOLLOWING TWO CONDITIONS: (1) THIS DEVICE  
MAY NOT CAUSE HARMFUL INTERFERENCE, AND  
(2) THIS DEVICE MUST ACCEPT ANY INTERFER-  
ENCE RECEIVED, INCLUDING INTERFERENCE  
THAT MAY CAUSE UNDESIRE OPERATION.



## ATTENTION

RISQUE D'ELECTROCUTION  
NE PAS OUVRIR



ATTENTION: POUR EVITER TOUT RISQUE D'ELECTROCUTION  
NE PAS OUVRIR LE BOITIER.  
AUCUNE PIECE INTERIEURE N'EST  
A REGLER PAR L'UTILISATEUR.  
SE REFERER A UN AGENT QUALIFIE EN CAS DE PROBLEME.



Le symbole de l'éclair à l'intérieur d'un triangle équilatéral est destiné à alerter l'utilisateur sur la présence d'une "tension dangereuse" non isolée dans le boîtier du produit. Cette tension est suffisante pour provoquer l'électrocution de personnes.



Le point d'exclamation à l'intérieur d'un triangle équilatéral est destiné à alerter l'utilisateur sur la présence d'opérations d'entretien importantes au sujet desquelles des renseignements se trouvent dans le manuel d'instructions.

\*Ces symboles ne sont utilisés qu'aux Etats-Unis.

**AVERTISSEMENT:**  
POUR EVITER LES RISQUES  
D'INCENDIE OU D'ELECTROCUTION, NE  
PAS EXPOSER L'APPAREIL A  
L'HUMIDITE OU A LA PLUIE.

Ce magnétoscope ne doit être utilisé que sur  
du courant alternatif en 120 V.

### ATTENTION:

Afin d'éviter tout resque d'incendie ou  
d'électrocution, ne pas utiliser d'autres  
sources d'alimentation électrique.

### REMARQUE:

La plaque d'identification (numéro de série) se  
trouve sur le panneau arrière de l'appareil.

### WARNING:

The battery used in the BR-DV6000U must be  
replaced by a JVC authorized service dealer only.

This digital apparatus does not exceed the Class B  
limits for radio noise emissions from digital  
apparatus as set out in the interference-causing  
equipment standard entitled "Digital Apparatus",  
ICES-003 of the Department of Communications.

Cet appareil numérique respecte les limites de  
bruits radioélectriques applicables aux appareils  
numériques de Classe B prescrites dans la norme  
sur le matériel brouilleur: "Appareils Numériques",  
NMB-003 édictée par le ministre des Communica-  
tions.

---

**Thank you for purchasing our  
DV Video Cassette Recorder  
BR-DV6000.**

---



As this is a DV-format video cassette recorder, video cassettes with the DV or Mini DV logo can be used with it.

DVCAM cassettes can be recorded in the DV format.

- In order to prevent crumpling due to tape slack, do not perform important recording within the first and last 2 – 3 minute-run of the tape.
- Recorded video (sound) is meant for personal entertainment only and must not be used for other purposes without the prior consent of the copyright owner.
- JVC shall not guarantee the quality of recording and playback should BR-DV6000 fail to function normally due to defects, either of the unit itself or the video cassette tapes.

## MAIN FEATURES

- **DV format**  
High picture and sound quality by digital technology.
- **Compatible mechanisms for standard/mini DV cassette tapes**  
It records on and plays back DV cassette tapes of the standard and mini size. (SP mode only)  
Recording in the DV format can be performed on DVCAM cassette tapes.
- **Only PAL/NTSC DVCAM tapes are detected automatically in playback mode.**
- **Equipped with composite, component and Y/C input & output terminals.**
- **Equipped with DV IN/OUT terminals. (IEEE1394)**  
It can exchange digital signals with IEEE1394-compatible devices.
- **Both NTSC and PAL signals supported**  
BR-DV6000 can playback or record PAL tapes through the DV input. For PAL, please set the PB/DV IN menu item to PAL.  
For analog signal input, only NTSC is supported.
- **RS-422A and JVC bus interface supported**  
RS-422A-compatible edit controller RM-G820 and JVC bus-compatible edit controller RM-G800/G805 can be used for editing.
- **Optionally, the RS-232C interface can be used.**
- **Recording and playback of time codes**
- **Time code I/O terminal**  
Slave lock is allowed if BR-DV6000 is connected to an external time code generator.
- **SYNC IN terminal**  
External synchronization signals can be input.
- **Audio-dubbing function (after-recording)**  
If the sampling frequency is 32 kHz, audio dubbing can be performed into CH3 and CH4 (except during DV input).
- **Backup recording function**  
With the combined use of other DV machines, long-time continuous recording is possible.
- **Using the SERIAL REMOTE OUT terminal or DV terminal, dubbing with other recorders is possible only with playback operation by BR-DV6000. (Replication function)**
- **Equipped with a 2.5-inch color LCD**  
Images, status display and menu display can be viewed.
- **Multi-cue up**  
Up to 5 points of the tape position can be registered and cued up.
- **Index/blank search function**  
It can search for positions where index signals are recorded and unrecorded parts.
- **Repeat play function**  
There are 3 types of repeat function.  
(INDEX/ VIDEO END/ TAPE END)
- **Recording/playback with an external timer**
- **With the use of the network board SA-DV6000 (sold separately), image and audio streaming data can be recorded on a CF card, and with a LAN card, streaming data can be transmitted to a PC.**
- **With the XLR IN board SA-X61U or XLR OUT board SA-X62U (sold separately), audio input/output via the XLR terminal is possible.**

# Table of Contents

---

## INTRODUCTION

Remarks of usage .....	6
Regular maintenance .....	7
Cleaning tape .....	8
Cassette tape .....	8
Condensation .....	9

## NAMES AND FUNCTIONS OF PARTS

Front panel .....	10
Rear panel .....	16

## ON-SCREEN DISPLAY

On-screen display .....	20
Status display .....	21
Status/Event display .....	23
Alarm display .....	24
LCD display .....	26

## CONNECTION

Connecting video signals .....	28
Connecting audio signals .....	30
Connecting to editing system .....	32
Connecting with serial remote terminals .....	34
Connecting the AC adapter .....	35

## PREPARATION

Turning on/off the power .....	36
Operation method (main unit/remote controller) and operation lock mode .....	37
Loading/Ejecting cassette .....	38
Setting the LCD display .....	39
Setting/Displaying date and time .....	40

## RECORDING

Setting .....	42
Recording procedure .....	43
Audio dubbing .....	44
Backup recording function .....	45
Recording with serial remote terminals .....	46
External timer recording .....	47

## PLAYBACK

Setting .....	48
Basic playback procedure .....	49
Special playback functions .....	50
Search function .....	52
Repeat playback .....	53
Multi cue-up .....	54
External timer playback .....	56
Dubbing with another machine using the SERIAL REMOTE OUT/DV terminals .....	57

## TIME CODE

Displaying the time code .....	58
Presetting the time code .....	59
Recording the time code .....	60
Playing back the time code .....	63

## EDIT

Editing with an RS-422A/JVC bus edit remote controller .....	64
Using a non-linear editing system .....	68

## MENU SCREENS

Structure of the Menu screens .....	69
Setting the menus .....	70
Description of the Menu screens .....	72

## RS-232C INTERFACE

Command tables .....	84
RS-232C specifications .....	85
RS-232C commands .....	86

## OTHERS

Warning display .....	97
Troubleshooting .....	99
Checking the hour meter .....	100
Optional devices .....	101
Installing SA-K46U RS-232C interface board .....	102
Specifications .....	103
Supplement .....	105

# INTRODUCTION

## Remarks of usage

### ■ Place of storage and use

Avoid storing or using this VCR in the following places:

- Excessively hot or cold places beyond the allowable temperature for operation (5°C – 40°C).
- Humid or dry places beyond the allowable humidity range for operation (30% – 80% RH).
- Dusty or sandy places.
- Places exposed to oil, smoke or steam, such as the kitchen vicinity.
- Intensely vibrating or unstable places.
- Places prone to condensation.
- Places that generate strong magnetic fields, e.g., near a transformer or motor.
- Places near devices that generate electric waves, e.g., a transceiver or mobile phone.
- Places that generate X-ray radiation or corrosive gases.

### ■ Handling the unit

- Do not place heavy objects on the unit, like a monitor or TV.
- Do not insert foreign objects into the cassette slot.
- Mind your finger when loading a cassette tape.  
Be careful not to get your fingers clamped when loading the cassette to prevent injury.
- Place this unit out of reach of young children to prevent injury as fingers may get clamped while a cassette tape is being loaded.
- Do not block the ventilation openings.
- Avoid strong impact to the unit. Do not drop the unit.
- Remove the cassette tape from the cassette slot when transporting the unit.
- Remove the AC adapter to save energy when the unit is not in use.

### ■ Maintaining the unit (Turn off the power before performing maintenance work.)

Wipe the unit with a soft cloth.

Do not wipe it with thinner or benzene as it may melt or tarnish the unit surface.

For stubborn stains, use water-diluted neutral detergent and then wipe it dry.

### ■ Use the supplied AC adapter to connect the unit to a power source.

### ■ Use the supplied power cord.

Using a different type or damaged cord may cause fire or electric shock.

### ■ Do not use the supplied power cord for other models.

### ■ LCD screen

The LCD screen is designed and manufactured with high-precision technology.

Minute black dots may appear or bright (red, blue and white) dots are permanently lit. This phenomenon is not a product defect and the dots are not recorded.

## Regular maintenance

This unit uses consumables or components that will wear off. If a worn-out or deteriorated component continues to be used, it may cause the unit to break down. To prevent this, perform routine maintenance using the head-cleaning tape. With the head-cleaning tape alone, however, the entire tape-winding mechanism cannot be completely cleaned.

Perform regular maintenance of the components as shown below.

### ■ Regular maintenance

The tasks of maintenance involved are similar to that of replacing the engine oil or tire of a car.

Depending on the number of usage hours, inspect or replace the components as follows:

Number of hours	500H	1000H	1500H	2000H	4000H
Drum assembly (including head)	○	○	○	●	●
Head cleaner	☆	●	☆	●	●
Tape guide, roller	○	☆	☆	●	●
Reel disk, tension bands	—	☆	—	●	●

— : Inspection

○ : Cleaning, inspection and adjustment

☆ : Cleaning and inspection; Replacement if necessary

● : Replacement

**Work and frequency of maintenance depend on the environment and usage. The above information serves only as a guide.**

### Usage Time

: You can check the drum usage time with the hour meter display. For details, refer to page 100, "Checking the hour meter."

### Maintenance consultation

: For details on the maintenance plan and fee, consult with your JVC-authorized service agent.

### ■ Head cleaning

- Recording or playing back with a dirty head will result in block noise or disrupted sound. Perform regular head cleaning to maintain superior image and sound quality.
- If the head is dusty, "HEAD CLEANING REQUIRED!" will be displayed on the monitor when this unit plays a tape.

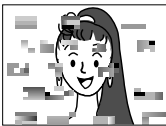

Block Noise



**HEAD CLEANING REQUIRED!**

- For information on how to use the head cleaning tape and the relevant remarks, refer to page 8, "Cleaning tape".

# INTRODUCTION

## Cleaning tape

Use a JVC cleaning tape.  
Follow the instructions below for using the cleaning tape.

1. Run the tape for 10 seconds in the **PLAY mode**. (Thereafter, it stops automatically and enters the **STOP mode**.)
  - After loading the cleaning tape, press the **PLAY** button.
2. For a single cleaning session, it can be repeated up to 4 times.
3. Refer to the following table as a guide for cleaning.

Operating environment	Low temperature 5°C to 10°C	Room temperature 10°C to 35°C	High temperature 35°C to 40°C
Frequency of cleaning	1 to 2 times every 5 hours	1 to 2 times every 20 to 30 hours	1 to 2 times every 5 hours

### Notes

- Under low humidity conditions, (10% RH to 30% RH), perform head cleaning at intervals of half of the periods stated in the table.
- If an M-DV80 tape is used immediately after cleaning, the message, “HEAD CLEANING REQUIRED!” may not disappear. It does only after the tape has run for some time.
- Use the cleaning tape at room temperature (10°C to 35°C).
- Instructions for using the cleaning tape stated on a sheet inside its storage case may be different in part from those stated here. Follow the instructions in this manual.

## Cassette tape

BR-DV6000 can record onto and playback standard DV and mini DV cassette tapes (for SP mode only).

Use the following JVC cassettes with the **DV** or the **mini DV** logo.

- **Standard DV cassettes**
  - LA-DV276
  - LA-DV186
  - LA-DV124
- **Mini DV cassettes**
  - M-DV63PRO
  - M-DV60
  - M-DV30

### Memo

- DVCAM cassette can be recorded in the DV format.
- Tapes recorded in the DVCAM format can be played (SP Mode).
- M-DV80 cassettes (Mini DV 80min tape) cannot be used with this unit.

### Remarks on the use of tape

- Do not load the videotape in the wrong direction.
- Store the tape only after it has been fully rewound, so as to avoid damaging the tape.
- Store the cassette in places low in humidity, well-ventilated and fungus-proof.
- When a cassette tape is used repeatedly, noise may increase due to e.g., dropout, etc. hence affecting its performance. Do not use dirty or damaged tapes as they will shorten the life span of the rotation head.

### Erasure prevention

DV cassettes have a safety slide at the back to prevent accidental erasure.

- To prevent accidental erasure of important records, push the slide to the “SAVE” position.
- To record, push the slide to the “REC” position.

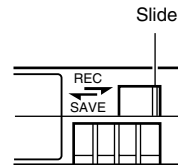



## ■ For recording and storing videotapes in the best condition

Observe the following instructions for the best recording and storage of videotapes.

- Take care of the conditions of handling videotapes.

It is recommended that you record and store videotapes in the environment below.

	Recording	Storage	
		Short period (Up to 10 years)	Long period (Over 10 years)
Temperature	17°C to 25°C	15°C to 23°C	15°C to 19°C
Humidity	30% to 70%	40% to 55%	25% to 35%
Hourly temperature change	Less than 10°C	–	–
Hourly humidity change	Less than 10%	–	–

- Do not leave the videotapes neglected for a long period.

If videotapes are left wound for a long period of time, it may result in distortion of the tape. Also it may cause tape-to-tape adhesion (known as blocking). It is recommended that videotapes be unspooled and rewound once a year for refreshing.

- When tapes are not in use, store them in cases and on end.

Storage cases protect videotapes from humidity, dust and ultraviolet. Keep tapes in cases and do not store them lying flat. When housed in a horizontal position, pressure from other tapes can cause distortions and deformations of the tape edges.

## Condensation

- When this unit is moved from a cold to a warm place abruptly, the vapor in the warm air will come into contact with the head drum or the tape guides, which are not warmed enough. When chilled, the vapor turns into droplets of water. This state is known as condensation. When condensation occurs, the videotape adheres to the head drum or the tape guides and will be damaged.

- Condensation occurs on this unit in the following circumstances:

- \* It is moved abruptly from a cold place to a warm place.
- \* It is used in a place immediately after the heater has been turned on, or when cold breeze from an air-conditioner blows onto it.
- \* It is used at a place of high humidity.

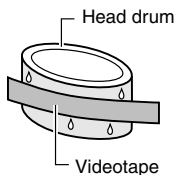

When a cassette tape is loaded, do not transport e.g., from a cold outdoor place to a warm room thus subjecting the unit to drastic temperature changes.

After moving the unit, do not use it until the inner mechanism stabilizes.

- When condensation occurs, the monitor displays the following warning:

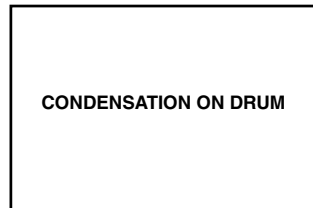

Leave the unit with the power ON and wait until the WARNING message disappears.

- Prevention of condensation  
When transporting BR-DV6000 from a cold to a warmer place abruptly, first remove the cassette tape. Then place BR-DV6000 in a plastic bag and seal it before transporting.  
Take out BR-DV6000 from the sealed plastic bag only after it has the same temperature as the surroundings.

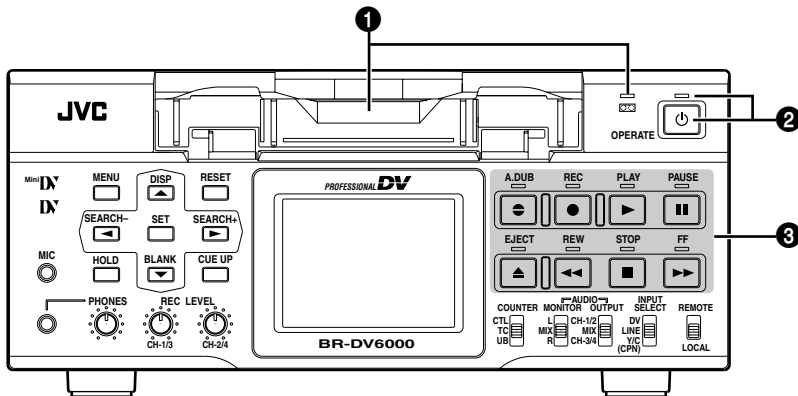

## ① Cassette loading slot/LED

- For loading a cassette into or unloading it from the slot. Insert a standard DV cassette or a mini DV cassette. (☞ Page 38)
- When BR-DV6000 is in the OPERATE OFF state and a cassette is loaded, it changes to the OPERATE ON state.
- With a cassette loaded, the LED lights up in green. When a cassette is being loaded or ejected, the LED flashes.

## ② [OPERATE] button/LED

- Press this button to turn on the power and BR-DV6000 becomes ready for operation. (Operate ON)  
Press this button again when BR-DV6000 is already on to turn off the power. (Operate OFF)
- OPERATE LED lights up as follows.  
Operate ON : the green LED lights up  
Operate OFF : the red LED lights up  
VCR error : the red LED blinks

### Memo

- If DC IN MODE in the SYSTEM MENU screen is set to "OPE ON" or the Timer Switch is set to "REC" or "PLAY" and power is supplied to the DC IN terminal located on the rear panel, BR-DV6000 goes into the OPERATE ON state even if this button is not pressed.
- Even after the power is turned off with this button, BR-DV6000 is live with a small amount of electricity. Therefore, if BR-DV6000 is not to be used for a long period of time, please remove the AC adapter to save energy.

## ③ Operation buttons

### ■ [A. DUB] Audio dubbing button/LED

- Press this button for audio dubbing (after-recording).  
For audio dubbing, set AUDIO MODE in the AUDIO MENU screen to "32K". The sound produced by the MIC terminal ④ or the AUDIO IN terminal is recorded on channels CH3 and CH4.
- During audio dubbing, the red A. DUB LED lights up.
- If the INPUT SELECT switch is set to DV, audio dubbing cannot be performed. (☞ Page 44 "Audio Dubbing")

### ■ [REC] button/LED

- Hold down this button and press the PLAY button to start recording. During recording, the red LED lights up.
- Hold down this button and press the PAUSE button to pause recording.
- If this button is pressed during recording, an index signal is recorded on the tape (when INDEX WRITE in the SYSTEM MENU screen is set to ON).
- When this button is pressed in the STOP mode, the time code generator value can be checked while the button is being held down. If TC DUPLICATE Menu is set to AUTO or NON DROP, the time code, date and time of the DV input can be checked.
- If this button is pressed during playback, the input signal can be checked while the button is held down. (EE check)  
EE check is not available for DV signal input.

### ■ [PLAY] button/LED

- Press this button to start playing back a tape. During playback, the green LED lights up.
- When recording is paused, press this button to resume recording.
- When audio dubbing is paused, press this button to resume audio dubbing.

### ■ [PAUSE] button/LED

- During recording, press this button to pause it.
- In the PLAYBACK or STOP mode, press this button to enter the STILL mode. In the RECORDING PAUSE or STILL mode, the green LED lights up.
- When BR-DV6000 is in the STILL mode, hold down the A.DUB button and press this button to enter into the audio-dubbing pause mode.
- When BR-DV6000 is in the STILL mode, press this button for frame advance playback.

#### Memo

Still images or images in frame advance can be selected with STIL/F.ADV of the SYSTEM (1/2) MENU screen.

### ■ [FF] button/LED

- When BR-DV6000 enters the STOP mode, press this button to fast-forward the tape.
- When BR-DV6000 is in the PLAYBACK or STILL mode, press this button for fast-forward playback. The fast forward playback speed can be changed by pressing the SEARCH +/▶ button **18** or the SEARCH -/◀ button (when “◀,▶” KEY FUNC in the SYSTEM (1/2) Menu screen is set to VAR). (Page 50 “Search Mode”)
- Hold down the PLAY button and press this button to perform playback in the forward direction at 1.07 times the normal speed. At this state, if the PLAY button is released first, the playback continues at 1.07 times the normal speed.  
If this button is released first, it plays back at the normal speed.
- During fast-forwarding or fast-forward playback, the LED lights up in green.

### ■ [STOP] button

- Press this button to stop operation.
- When BR-DV6000 is in the STANDBY OFF mode, press this button to enter the STANDBY ON mode.

#### Memo

There are two stop modes.

- STANDBY OFF: For protecting the tape and the drum, the drum does not rotate.
- STANDBY ON: The drum rotates so that it starts up faster after BR-DV6000 moves into another mode.

### ■ [REW] button/LED

- When BR-DV6000 enters the STOP mode, press this button to rewind the tape.
- When BR-DV6000 is in the PLAYBACK or STILL mode, press this button for reverse playback. The rewind playback speed can be changed by pressing the SEARCH +/▶ button **18** or the SEARCH -/◀ button (when “◀,▶” KEY FUNC in the SYSTEM (1/2) Menu screen is set to VAR). (Page 50 “Search Mode”)
- Hold down the PLAY button and press this button to perform playback in the reverse direction at 0.9 times the normal speed. At this state, if the PLAY button is released first, the playback continues at 0.9 times the normal speed.  
If this button is released first, it plays back at the normal speed.
- During rewinding or rewind playback, the LED lights up in green.

### ■ [EJECT] button

- Press this button to eject the cassette.

#### Memo

- It takes about 6 seconds for the cassette to be ejected.
- The cassette can be ejected even when BR-DV6000 is in the OPERATE OFF mode. After the eject action is completed, BR-DV6000 returns to the OPERATE OFF mode.

# NAMES AND FUNCTIONS OF PARTS

## - Front panel - (continued)

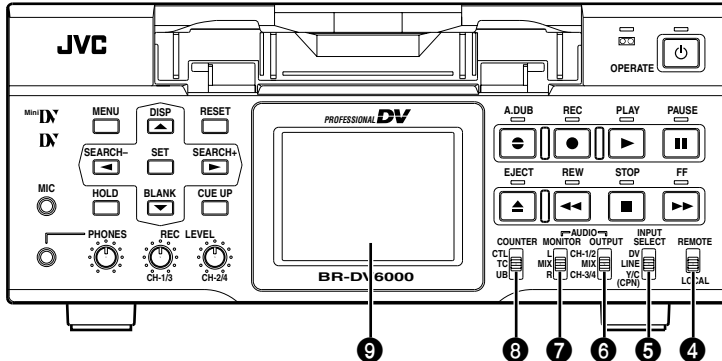

### 4 [REMOTE/LOCAL] switch

This switch is used to select how BR-DV6000 is to be operated.

**LOCAL** : Use this setting if BR-DV6000 is to be controlled with the key operation of the unit.

**REMOTE** : Use this setting if BR-DV6000 is to be controlled using the edit controller connected to the REMOTE 1 (9-PIN) terminal or REMOTE 2 (12-PIN) terminal.

When it is set to REMOTE, settings can be performed at the REMOTE (1/2) MENU screen to enable/disable operation via the 9-PIN or 12-PIN REMOTE terminal.

The 9-PIN REMOTE 1 terminal can be selected using REMOTE SEL 9 PIN while the 12-PIN REMOTE 2 terminal can be selected with REMOTE SEL JVC.

### Memo

- To control BR-DV6000 with the SERIAL REMOTE terminal or DV terminal, this switch setting can be set up with REMOTE SEL SERIAL or REMOTE SEL DV in the REMOTE (1/2) MENU screen. (Page 75)
- If it is set to REMOTE, the buttons that can be operated from the unit are selectable from LOCAL FUNCTION in the REMOTE (1/2) MENU screen.

### 5 [INPUT SELECT] switch

This switch is used to select input signals.

**DV** : For DV signals of the DV IN/OUT terminal (IEEE1394)

**LINE** : For inputting the composite images of the LINE IN terminal and analog audio signals.

**Y/C (CPN)** : For inputting the YC separate video signal of the Y/C IN terminal and the component video signal of the COMPONENT IN terminal. The selection of the YC separate signal or the component video signal can be done with VIDEO INPUT SEL in the VIDEO MENU screen. For audio, analog sound is input.

### Note

Switching is invalid during recording.

### 6 [AUDIO OUTPUT] switch

Use this switch to select the audio channel from the headphone terminal and the AUDIO OUT terminal located on the rear panel.

This switch is valid in the following conditions.

- During playback of tapes recorded in the 32k audio mode
- In the EE mode for DV input in the 32k audio mode
- During audio dubbing

**CH-1/2** : For outputting the sound of the channels CH1 and CH2.

**MIX** : For outputting the mixed sound of CH1 and CH3 from the CH-1/3 AUDIO OUT terminal and the mixed sound of CH2 and CH4 from the CH-2/4 AUDIO OUT terminal.

**CH-3/4** : For outputting the sound of CH3 and CH4.

## Memo

- For the MIX setting, noise is sometimes generated. If it occurs, set it to CH-1/2 or CH-3/4.
- In the 48 K audio mode, it is fixed at channels CH1 and CH2 regardless of the setting of the switch.

## 7 [AUDIO MONITOR] switch

Use this switch to select the audio channel for output signals from the headphone terminal and the AUDIO MONITOR terminal located on the rear panel.

The output signal of the AUDIO MONITOR OUT terminal is monaural.

**L** : For outputting the sound of CH1.

**MIX** : For outputting the mixed sound of CH1 and CH2.

**R** : For outputting the sound of CH2.

## Memo

In the following conditions, if this switch and the 6 AUDIO OUTPUT switch are used in combination, the AUDIO MONITOR OUT outputs the sounds listed as in the following table.

- During playback of tapes recorded in the 32 K audio mode
- In the EE mode for DV input in the 32 K audio mode
- During audio dubbing

AUDIO switch		MONITOR OUT output channel
MONITOR	OUTPUT	
L	CH-1/2	CH1
	MIX	CH1/3 mix
	CH-3/4	CH3
MIX	CH-1/2	CH1/2 mix
	MIX	CH1/2/3/4 mix
	CH-3/4	CH3/4 mix
R	CH-1/2	CH2
	MIX	CH2/4 mix
	CH-3/4	CH4

## 8 [COUNTER] switch

The switch changes the contents of the counter display of the 9 LCD and the monitor.

**CTL** : It displays the counter in hour, minute, second and frame based on CTL (control signal).

**TC** : It displays the time code data.

**UB** : It displays the user's bit (UB).

## 9 LCD

■ In the playback, still or search mode, it displays the playback image.



In the recording, recording pause, stop, fast-forwarding or rewinding mode, it displays the input image.

■ The following information is also displayed.

- Various types of information (status display), e.g., operation mode, date/time, counter
- Menu screen
- Warning display

(For details,  Page 20)

## Memo

- Use the 18 DISP button to enable/disable the LCD display and the display style.
- LCD-related settings, e.g., brightness adjustment of the LCD, are performed in the DISPLAY MENU screen.  
( Page 39 "Setting the LCD display")  
( Page 82 "DISPLAY MENU screen")
- If the same image pattern is kept displayed on the LCD display for a prolonged period of time, "ghosting", the permanent etching of a pattern on a display screen, may occur. To prevent this, turn off the LCD display when it is not in use.

# NAMES AND FUNCTIONS OF PARTS

## - Front panel - (continued)

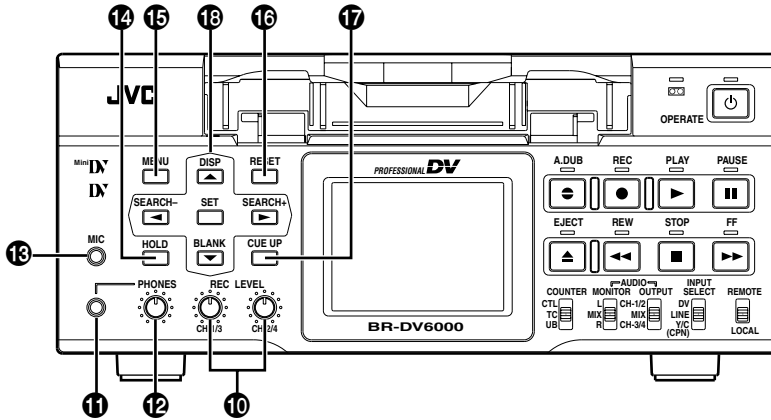

### 10 [REC LEVEL] Volume for audio recording level for CH1/3 and CH2/4

Use the switch to adjust the audio recording level for CH1 and CH2.

During audio dubbing, the audio recording level for CH3 and CH4 can be adjusted with this switch.

#### Memo

- During DV input, the volume control is not effective.
- During MIC input, only the volume for CH1/3 REC LEVEL is valid.

### 11 [PHONES] terminal

This is the mini jack terminal for connecting to the headphone. (Stereo  $\phi$ 3.5)

- When BR-DV6000 plays back tapes recorded in the 32 kHz mode, the audio channel for outputting from this terminal is selected with the 8 AUDIO OUTPUT switch.

### 12 [PHONES] Headphone volume

Use this switch to adjust the output level of the PHONES terminal.

Both channels are adjusted at the same time.

### 13 [MIC] terminal

This is the mini jack terminal for monaural microphone input.

To input sound from a microphone, set the [INPUT SELECT] switch to LINE or Y/C (CPN).

If a microphone is connected, sound for the AUDIO IN terminal located on the rear panel cannot be input.

The sound of the microphone is recorded to CH1/CH2 in the recording mode and CH3/CH4 in the audio-dubbing mode.

### 14 [HOLD] button

If this button is pressed in the LCD enlarged display mode, the time code preset screen will be displayed on the LCD. When the time code preset screen is displayed, press this button to return to the normal display.

( Page 59 "Presetting time code")

### 15 [MENU] button

If this button is pressed when BR-DV6000 is in the STOP/STILL mode or when no cassette is loaded, the menu is displayed on the LCD or the monitor connected to the VIDEO MONITOR OUT terminal.

When the menu is displayed, press this button to return to the normal display.

( Page 70 "Setting the menu")

### 16 [RESET] button

- To reset the CTL counter display to "00", press this button.

- If this button is pressed when the time code preset screen is displayed, all the digits of the time code or the user's bit are reset to "00".

- When the Multi Cue-up screen is displayed, press this button to clear the registered cue-up points.

### 17 [CUE UP] button

When the 8 COUNTER switch is set to TC, press this button to display the Multi Cue-up screen on the monitor or LCD.

When the Multi-Cue-up screen is displayed, press this button to start searching the selected tape position.

( Page 54 "Multi Cue-up")

## 13 Special functions/Setting buttons

The following buttons have different functions depending on whether the normal screen or the setting screen is displayed.

### Setting screens:

Menu, Date/Time setting, Time code preset and Multi Cue-up

#### ■ [DISP/▲] button

- During normal display, this button is used to enable/disable the LCD or select display style. When this button is pressed, the LCD display changes in the following manner.  
Enlarged character display → Image/enlarged character display → Image/character display → Image display → No display → Enlarged character display...
- When the setting screen is displayed, this button is used to select the items or setting values.

#### ■ [BLANK/▼] button

- When BR-DV6000 is in the stop mode, press this button to start blank search. It searches the unrecorded part of the tape and goes into the still mode.  
(☞ Page 52 “Blank search”)
- When the setting screen is displayed, this button is used to select the items or setting values.

#### ■ [SEARCH+/▶] button

- During normal display, the function of this button can be selected using “◀,▶” KEY FUNC in the SYSTEM (1/2) Menu screen.  
If it is set to VAR, the searching speed increases if this button is pressed during a search operation.  
(☞ Page 50 “Search mode”)  
If it is set to INDEX, press this button to start forward index search. This function is not effective during recording or recording pause.  
(☞ Page 52 “Index search”)
- When the setting screen is displayed, this button is used to select items or setting digits.

#### ■ [SEARCH-/◀] button

- During normal display, the function of this button can be selected using “◀,▶” KEY FUNC in the SYSTEM (1/2) Menu screen.  
If it is set to VAR, the searching speed decreases if this button is pressed during a search operation.  
(☞ Page 50 “Search mode”)  
If it is set to INDEX, press this button to start reverse index search. This function is not effective during recording or recording pause.  
(☞ Page 52 “Index search”)
- When the setting screen is displayed, this button is used to return to the previous menu or select setting digits.

#### ■ [SET] button

- When the Menu screen, Date/Time setting screen or the Multi Cue-up screen is displayed, press this button to confirm the setting value.
- When the time code preset screen is displayed, press this button to preset the selected time codes or user's bit to the time code generator.

# NAMES AND FUNCTIONS OF PARTS

- Rear panel -

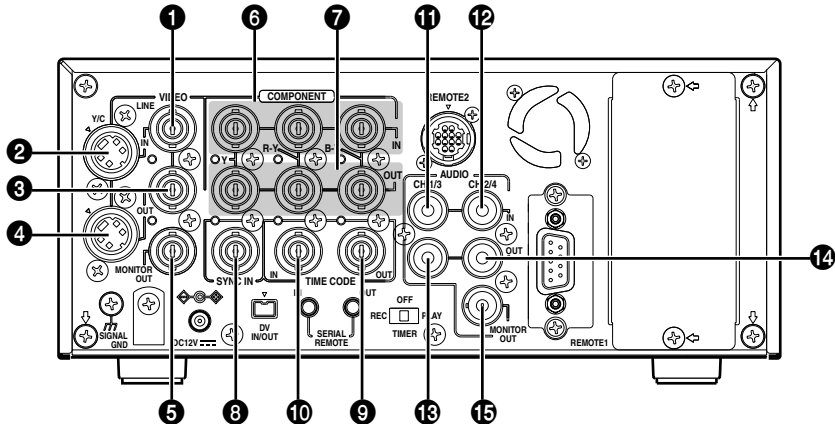

## ① [VIDEO LINE IN] terminal (BNC)

This is the input terminal for composite video signals.

- To input video via this terminal, set the INPUT SELECT switch located on the front panel to "LINE".

## ② [VIDEO Y/C IN] terminal (4-PIN)

This is the input terminal for Y/C separate video signals.

- To input video via this terminal, the following settings are required.

Set VIDEO INPUT SEL in the VIDEO Menu screen to "Y/C".

Set the INPUT SELECT switch located on the front panel to "Y/C (CPN)".

- When wide-screen ID signals are input, the wide-screen ID signal is recorded.

## ③ [VIDEO LINE OUT] terminal (BNC)

This is the output terminal for composite video signals.

## ④ [VIDEO Y/C OUT] terminal (4-PIN)

This is the output terminal for Y/C separate video signals.

- When tapes that have recorded wide-screen signals are played back, the wide-screen ID signal is output.

## ⑤ [VIDEO MONITOR OUT] terminal (BNC)

This terminal is for connecting to a monitor-TV.

- It outputs composite video signals.
- It displays the Menu setting screen, Date/Time setting screen and warning information.
- If DISPLAY in the DISPLAY Menu screen is set to "ON" or "AUTO", information will be displayed on-screen, e.g., the operation mode, date/time and counter. (Page 20)

## ⑥ [COMPONENT IN] terminal (BNC × 3)

This is the input terminal for component video signals (Y/R-Y/B-Y). The signal level is high (β cam spec).

- To input video of this terminal, the following settings are required.

Set VIDEO INPUT SEL in the VIDEO Menu screen to COMPONENT.

Set the INPUT SELECT switch located on the front panel to "Y/C (CPN)".

## ⑦ [COMPONENT OUT] terminal (BNC × 3)

This is the output terminal for component video signals (Y/R-Y/B-Y). The signal level is high (β cam spec).

### Memo

Whether or not to enable SET UP for analog signals (composite, YC separate and component signals) can be selected with SET UP in the VIDEO Menu screen (for NTSC only).



### 8 [SYNC IN] synchronization input terminal (BNC)

This is the terminal for inputting reference synchronization signals from an external source. For external synchronization signals, input composite video signals of 1V (p-p) or lower (e.g., black burst signal).

(☞ Page 29 "Synchronization signal")

### 9 [TIME CODE IN] terminal (BNC)

This is the SMPTE-compliant time code input terminal.

It is for connecting to an external time code generator.

For external time code signals, use those that synchronize with the video signals.

- To input external time codes, set TCG SOURCE of the TC/UB/CLOCK Menu to "EXTERNAL".

### 10 [TIME CODE OUT] terminal (BNC)

This is the SMPTE-compliant time code output terminal.

It outputs time codes recorded on the tape during playback and data generated by the time code generator during recording.

With the COUNTER switch set to CTL, time code is not output.

### 11 [CH1/3 AUDIO IN] terminal (RCA)

Use this terminal to input analog audio signals.

To enable audio input via this terminal, set the INPUT SELECT switch located on the front panel to "LINE" or "Y/C (CPN)".

Usually, analog signals are recorded on CH1.

For audio dubbing, they are recorded on CH3.

### 12 [CH2/4 AUDIO IN] terminal (RCA)

Use this terminal to input analog audio signals.

To enable audio input via this terminal, set the INPUT SELECT switch located on the front panel to "LINE" or "Y/C (CPN)".

Usually, analog signals are recorded on CH2.

For audio dubbing, they are recorded on CH4.

#### Memo

If the AUDIO IN terminal and the MIC terminal located on the front panel are used simultaneously, the MIC terminal will precede.

### 13 [CH1/3 AUDIO OUT] terminal (RCA)

Use this terminal to output analog audio signals.

In the 48k audio mode, it outputs the sound of CH1.

When audio dubbing is paused, it outputs the sound of CH3.

In the 32k audio mode, the sound is selected with the AUDIO OUTPUT switch located on the front panel.

(Refer to the table below.)

### 14 [CH2/4 AUDIO OUT] terminal (RCA)

Use this terminal to output analog audio signals.

In the 48k audio mode, it outputs the sound of CH2.

When audio dubbing is paused, it outputs the sound of CH4.

In the 32k audio mode, the sound is selected with the AUDIO OUTPUT switch on the front panel.

(Refer to the table below.)

#### Memo

In the following modes, the channel that receives output signals from the AUDIO OUT terminal can be selected with the AUDIO OUTPUT switch.

- During playback of tapes recorded in the 32k audio mode
- During audio dubbing
- In the EE mode for DV input in the 32k audio mode

AUDIO OUTPUT switch	AUDIO OUT terminal	
	CH1/3	CH2/4
CH1/2	CH1	CH2
MIX	CH1, 3 mix	CH2, 4 mix
CH3/4	CH3	CH4

### 15 [AUDIO MONITOR] terminal (RCA)

This terminal is for connecting to a monitor TV and monitors the sound from its speakers.

Monaural sounds are output.

- The audio channel to be monitored can be selected with the AUDIO MONITOR switch located on the front panel.

For audio channels that receive output signals from this terminal in the 32k audio mode, refer to the table in page 13.

# NAMES AND FUNCTIONS OF PARTS

- Rear panel - (continued)

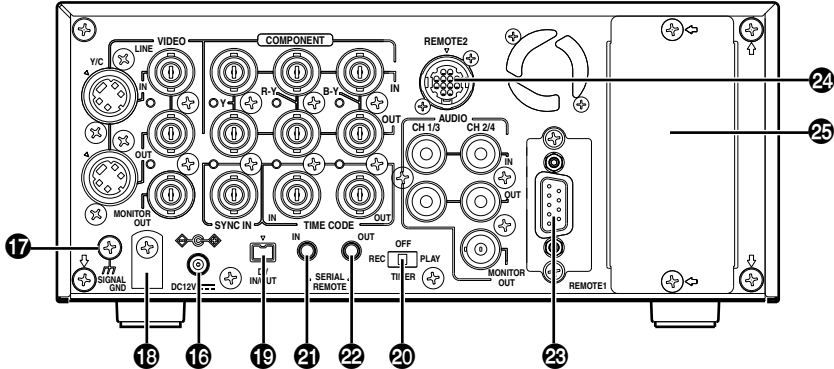

## 16 DC power input terminal (2-PIN)

This terminal is for inputting DC 12 V. Connect the DC power cord of the supplied AC adapter.

### Memo

- When power is supplied to this terminal, the OPERATE indicator located on the front panel lights up. (The indicator turns red when BR-DV6000 is in the OPERATE OFF state)
- Whether to set BR-DV6000 to enter the OPERATE ON mode or OPERATE OFF mode when power is supplied to the terminal can be selected with DC IN MODE in the SYSTEM (2/2) Menu screen.
- If the 20 [TIMER] switch on the rear panel is set to "REC" or "PLAY", recording or playback will be automatically started when power is supplied to the terminal. (Timer recording/playback)

## 17 [SIGNAL GND] terminal

This is the grounding terminal for signals.

## 18 DC power cord clamp

Use this clamp to fasten the DC power cord.

## 19 [DV IN/OUT] terminal

This is the input/output terminal for IEEE1394-compliant digital signals. It is for connecting to video equipment with a DV terminal.

- To enable signal input via this terminal, set the INPUT SELECT switch located on the front panel to "DV".
- Signals that come from this terminal are output regardless of the setting of the INPUT SELECT switch.
- If REPLICATION of the SYSTEM (2/2) Menu is set to DV, the REC command is output from this terminal when BR-DV6000 begins playback. (REPLICATION mode)
- Set PB/DV IN in the SYSTEM(2/2) Menu screen according to the signal format to be input to this terminal. (NTSC or PAL)

## 20 [TIMER] recording/playback switch

This switch is for setting BR-DV6000 to start timer recording or timer playback when power is supplied to the 16 DC power input terminal according to an external timer.

- OFF** : No timer recording or timer playback.
- REC** : When power is supplied, BR-DV6000 starts recording automatically. (Timer recording)
- PLAY** : When power is supplied, BR-DV6000 starts playback automatically. (Timer playback)

### Memo

- If the TIMER switch is set to "REC" or "PLAY", BR-DV6000 automatically enters the OPERATE ON mode upon DC power on even when DC IN MODE in the SYSTEM (2/2) Menu screen is set to "OPE OFF".

## 21 [SERIAL REMOTE IN] terminal (mini jack)

This terminal is for connecting to the serial remote controller RM-G30 (sold separately). To operate BR-DV6000 with this terminal, perform the following settings.

- Set REMOTE SEL SER in the REMOTE (1/2) Menu screen to "ON" or "LOC+REM."
- ON** : When the 4 REMOTE / LOCAL switch on the front panel is set to "REMOTE", this terminal becomes effective.
- LOC+REM**: This terminal is effective regardless of the setting of the 4 REMOTE / LOCAL switch on the front panel.

### Memo

- To use this terminal as the foot switch input, set FOOT SW in the REMOTE (2/2) Menu screen. (Page 77)

## 22 [SERIAL REMOTE OUT] terminal (mini jack)

- This terminal is for direct through-output of serial commands of the serial remote input terminal. (Only with OPERATE ON)
- If REPLICATION of the SYSTEM (2/2) Menu screen is set to SERIAL, this terminal outputs REC commands when BR-DV6000 begins playback. (REPLICATION mode) Use this function to connect BR-DV6000 to a dubbing device for dubbing its playback video or playback sound.

## 23 [REMOTE 1] RS-422A terminal (D-SUB 9-PIN)

This terminal is for connecting to an RS-422A serial interface-compatible editing remote controller (e.g. RM-G820).

With this terminal, BR-DV6000 can be used as a player or recorder of an editing system.

To operate BR-DV6000 with RS-422A, perform the following settings.

- Set REMOTE SEL 9-PIN in the REMOTE (1/2) Menu screen to "ON".
- Set the 4 REMOTE / LOCAL switch on the front panel to "REMOTE".

### Memo

- Use screws, of the inch, not metric, system, for fastening the connectors.
- This part can be replaced by the RS-232C serial interface board SA-K46U (sold separately).  
Consult your JVC authorized service agent for such replacements.

## 24 [REMOTE 2] JVC Bus terminal (12-PIN)

This terminal is for connecting to the JVC bus interface-compatible editing remote controller (RM-G800, RM-G805).

With this terminal, BR-DV6000 can be used as a player or recorder of an editing system.

To operate BR-DV6000 with this terminal, perform the following settings.

- Set REMOTE SEL JVC in the REMOTE (1/2) Menu screen to "ON".
- Set the 4 REMOTE / LOCAL switch on the front panel to "REMOTE".

## 25 Slot cover for an optional board

This cover can be removed to install any of the following optional boards.

- SA-DV6000 network board
- SA-X61U AUDIO XLR IN board (2ch)
- SA-X62U AUDIO XLR OUT board (2ch)

### Memo

- With the SA-X61U AUDIO XLR IN board installed, whether sound signals are input to the XLR IN terminal or the AUDIO IN terminal can be selected with AUDIO INPUT SEL in the AUDIO MENU. If the MIC terminal is in use, the MIC terminal precedes.
- With the SA-X62U AUDIO XLR OUT board installed, the audio channel to which signals are output can be selected with the AUDIO OUTPUT switch.

# ON-SCREEN DISPLAY

## - On-screen display -

Besides E-E images and playback images, the monitor connected to the VIDEO MONITOR OUT terminal provides the following on-screen information. Press the DISPLAY button to display the same information on the LCD screen of BR-DV6000.

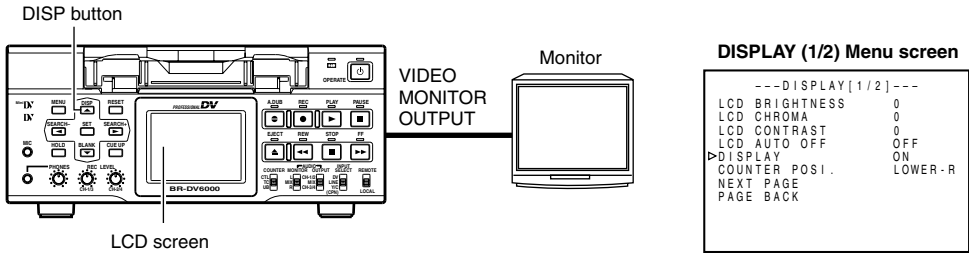

On-screen display	Description	Operation
<b>Status display</b>	Displays the setting status of the VCR operation mode, date/time, counter.	Settings can be performed with DISPLAY in the DISPLAY (1/2) Menu screen.
<b>Event display</b>	Displays the operating status of blank search, index recording/search.	<b>ON</b> : Always display. According to each event or error, the event and alarm displays are shown for about 3 seconds.
<b>Alarm display</b>	Displays error/alarm messages for incorrect operation or improper condition of BR-DV6000.	<b>AUTO</b> : It displays for about 4 seconds during mode changes. <b>OFF</b> : No on-screen display. The alarm display is shown according to errors, which occurred.
		<b>Display on the LCD</b> The on-screen display changes whenever the DISPLAY button is pressed. (☞ Page 26)
<b>Warning display</b>	When an error occurred with the VCR, it displays warnings with the relevant error codes. (☞ Page 98)	It is displayed automatically when an error with the VCR occurred.
<b>Menu display</b>	Displays the menu setting screen. (☞ Page 69)	When BR-DV6000 enters the STOP/ STILL mode or no cassette tape is loaded, the menu is displayed when the MENU button is pressed.
<b>Multi Cue-up screen</b>	Displays the Multi Cue-up screen for registering or selecting cue-up (searching) point. (☞ Page 54)	When BR-DV6000 enters the STOP, STILL or PLAY mode, press the Cue-up button to display the Multi Cue-up screen.

# ON-SCREEN DISPLAY

## - Status display -

■ **Status display:** It displays the current settings and operating status.

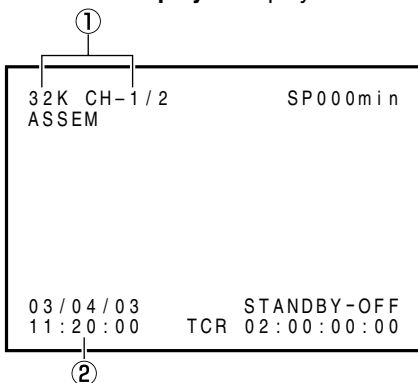

### Memo

- With the DATE REC function in use, the last line is fixed to the date/time display. The information displayed on the last line moves to the line above. (DATE REC function: Page 81)

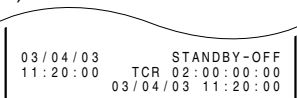

No.	Item	Description
①	<b>Sampling frequency/audio output CH</b>  <b>Memo</b> If the counter display position is set to the upper left, this item will be displayed on the lower right.	<ul style="list-style-type: none"> <li>• Sampling frequency During recording, the setting value of AUDIO MODE in the AUDIO Menu screen is displayed (32k or 48k). During playback, the sampling frequency of the sound recorded on the tape is displayed (32k, 48k, 44.1k). During DV signal input, the sampling frequency of the sound input is displayed.</li> <li>• A.LOCK Lights up when the video and audio sampling clocks (at 48kHz) are synchronized in the PLAYBACK mode. Always lights up in the RECORDING mode and EE mode.</li> <li>• Audio output channel The audio channel output from the AUDIO OUT terminal is displayed (CH1/2, CH3/4, MIX). (only in 32k mode)</li> <li>• With AUDIO INFO. in the DISPLAY Menu screen, whether to display this item can be selected.</li> </ul>
②	<b>Date/time</b>  <b>Memo</b> If the display position of the counter is set to the lower left, this item will be displayed on the lower right.	<ul style="list-style-type: none"> <li>• It displays the date (MM/DD/YY) and time (HR:MM:SS).</li> <li>• When the unit is in the RECORDING or STOP mode, it displays the data of the built-in clock.</li> <li>• During playback, fast-forwarding or rewinding, the data recorded on the tape is displayed.</li> <li>• During DV signal recording, the data from the DV terminal is displayed. If the REC button is pressed in the STOP mode, the input data from the DV terminal will be displayed.</li> <li>• The style for displaying the date and time can be selected with DATE STYLE and TIME STYLE in the DISPLAY Menu screen.</li> <li>• Whether to display date/time and the type of display can be selected with TIME/DATE in the DISPLAY Menu screen.</li> <li>• When the data/time is not set or when a tape is played with no date/time data recorded, “- -” will be displayed.</li> </ul>

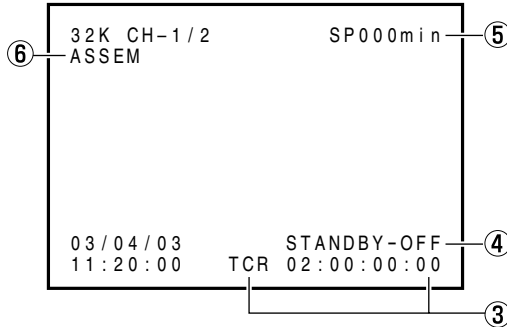

No.	Item	Description
③	Counter display	<p>Displays the CTR counter, time code or user's bit. The displayed contents can be selected using the COUNTER switch.</p> <ul style="list-style-type: none"> <li>• CTL counter: It will be displayed if the COUNTER switch is set to CTL. The counter shows a 7-digit number (hour, minute, second and frame) with + or - and "CTL" at the beginning, e.g., CTL-9:30:20:10</li> <li>• Time code : It will be displayed if the COUNTER switch is set to TC. The time code shows an 8-digit number (hour, minute, second and frame). At playback, the time codes recorded on the tape are displayed. The prefix indicates the time code mode. TCG : Time code generator data TCR : Time code reader data DTCG : Time code data received from the DV IN / OUT terminal ETCG : External time code generator data Depending on the framing mode, the symbols for the seconds and frames are different (only for NTSC). <b>00 : 00 : 00 : 00</b>  <ul style="list-style-type: none"> <li>Dot (.) for the drop frame mode</li> <li>Colon (:) for the non-drop frame mode</li> </ul> </li> <li>• User's bit : it will be displayed if the COUNTER switch is set to UB. The user's bit is an 8-digit number (each digit is a number or character from 0 - F). The prefix indicates the user's bit mode. UBG : User's bit generator data UBR : User's bit reader data DUBG : User's bit reader data received from the DV IN / OUT terminal EUBG : External user's bit generator data</li> </ul> <div style="border: 1px solid black; padding: 5px; margin-top: 10px;"> <p><b>Memo</b></p> <ul style="list-style-type: none"> <li>• The position of the counter display can be changed with COUNTER POS1 in the DISPLAY Menu screen.</li> <li>• The counter display can be turned on/off with TIME CODE in the DISPLAY Menu screen.</li> </ul> </div>

# ON-SCREEN DISPLAY

## - Status/Event display -

No.	Item	Description
④	<b>VCR operation mode</b>	Displays the VCR operation mode, including: PLAY, EJECT, FF, REW, STANDBY-ON, STANDBY-OFF, STILL, REC, REC PAUSE, A. DUB, A. DUB PAUSE, ASSEM EDIT, INSERT EDIT, SHTL (shuttle search), JOG, BLANK SRH (blank search), NO CASSETTE (cassette tape not loaded), OPERATE OFF. For SHTL and JOG, the speed is also displayed. • The display can be turned on/off with VTR MODE in the DISPLAY Menu screen.
⑤	<b>Remaining tape</b> <b>Memo</b> If the counter display position is set to the upper right, this item will be displayed on the lower right.	Displays the remaining time of tape (minutes). Not displayed when the remaining time is being confirmed. • The display can be turned on/off with TAPE REMAIN in the DISPLAY Menu screen. • The SP display disappears when a DVCAM cassette tape is being played back. • This remaining tape time display is only for reference.
⑥	<b>Edit mode display</b> <b>Memo</b> • With the counter display shown on the top left, this display appears on the bottom right. • In the 48 k audio mode, insert editing is not possible in the following cases. INS A1, INS A2, INS VA1, INS VA2	Displays the edit mode selected, e.g., by using the edit mode controller. • ASSEM : Assemble editing • INS V : Video insert editing • INS A : Audio insert editing (Audio: both CH 1 and CH 2) • INS VA : Video, audio insert editing (Audio: both CH 1 and CH 2) • INS VA : Video/Audio insert editing • INS TC : Time code insert editing (Time code only) <b>Insert editing in the 32 k audio mode</b> • INS A12 : CH1, CH2 audio • INS A34 : CH3, CH4 audio • INS VA12: Video & CH1, CH2 audio • INS VA34: Video & CH3, CH4 audio • INS A : CH1 to CH4 audio • INS VA : Video & CH1 to CH4 audio The display can be turned on/off with EDIT INFO in the DISPLAY Menu screen.

■ **Event display** : When certain functions are in use, it is displayed at the following positions (with the DISPLAY mode ON or AUTO).

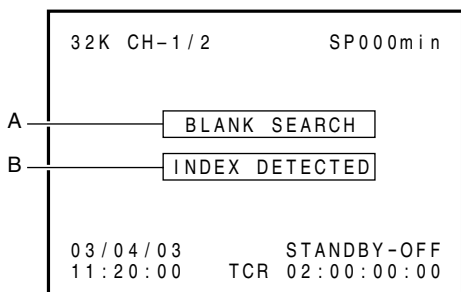

● **“A” display: displayed during operation**

Display	Description
BLANK SEARCH	Blank search in progress.
INDEX +1	Index search in progress. The number indicates the index search position.
INDEX MARK	When an index has been specified on the tape during recording.

● **“B” display: displayed for about 3 seconds**

Display	Description
INDEX DETECTED	An index has been detected during index repeat operation.
VIDEO END DETECTED	The video end has been detected during end repeat operation.

- Alarm display:** An alarm message is displayed at the following positions when there has been an operation error or when BR-DV6000 is not in good condition, e.g., dirty head.

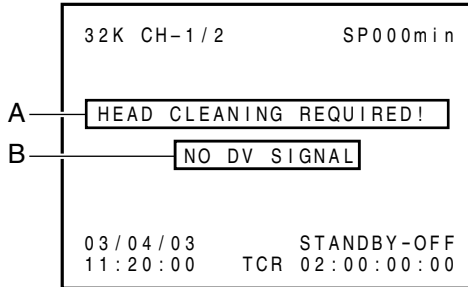

- “A” display :** The state of BR-DV6000 is displayed. It continues to be displayed until the error state is corrected. This display is not affected by the setting of the display mode.

Display	Description
<b>LOW VOLTAGE</b>	The voltage of the DC power source is low. If the operation continues, it enters the Operate OFF mode.
<b>HEAD CLEANING REQUIRED!</b>	The video head is dirty. Clean it with the head-cleaning tape exclusively for BR-DV6000. (Page 8) If the head is clogged, it is detected in the PLAYBACK mode and this message is displayed.
<b>OVERHEATING!</b>	The temperature inside BR-DV6000 has exceeded the stated value. Disconnect the power and place it at a cool place. If this message is displayed again, BR-DV6000 could be defective. Consult your JVC-authorized service agent.

- “B” display :** Messages for incorrect operation are displayed for about 3 seconds. They are displayed when the DISPLAY mode is ON or AUTO.

Display	Description
<b>INVALID TAPE!</b>	Data tape for PCs or DVC PRO tape is used. The cassette tape will be automatically ejected.
<b>LP TAPE!</b>	The user attempted to play back a tape recorded in the LP mode. BR-DV6000 cannot record or play in the LP mode.
<b>NO DV SIGNAL</b>	The user attempted to record without DV signal input.
<b>COPY INHIBIT</b>	The user attempted to record copy-guarded signals.
<b>REC INHIBIT</b>	The user attempted to record on a tape that is not ready for recording (the rear switch is set to SAVE).
<b>REC INHIBIT (NTSC/PAL)</b>	The user attempted to record analog signals when PB/DV IN in the SYSTEM (2/2) Menu is set to PAL.



<b>Display</b>	<b>Description</b>
<b>A. DUB INHIBIT (REC TAB)</b>	The user attempted to perform audio dubbing on a tape that is not ready for recording (the rear switch is set to SAVE).
<b>A. DUB INHIBIT (48 K)</b>	This message is displayed when audio dubbing is attempted under the following conditions. <ul style="list-style-type: none"> <li>• AUDIO MODE of the AUDIO Menu screen is set to 48 K.</li> <li>• The tape is recorded with a sampling frequency of 48kHz</li> </ul>
<b>A. DUB INHIBIT (LP)</b>	The user attempted to perform audio dubbing on a tape recorded in the LP mode.
<b>A. DUB INHIBIT (BLANK)</b>	The user attempted to perform audio dubbing of a blank tape.
<b>A. DUB INHIBIT (DV)</b>	The user attempted to perform audio dubbing during DV signal input (with the INPUT SELECT switch set to "DV").
<b>A. DUB INHIBIT (NTSC/PAL)</b>	The user attempted audio dubbing when PB/DV IN in the SYSTEM (2/2) Menu screen is set to PAL.
<b>A. DUB INHIBIT (DVCAM)</b>	The user attempted to perform audio dubbing on a DVCAM format tape.
<b>EDIT INHIBIT (REC TAB)</b>	The user attempted to edit a tape that cannot be recorded (with the rear switch set to "SAVE").
<b>EDIT INHIBIT (LP)</b>	The user attempted to edit a tape recorded in the LP mode.
<b>EDIT INHIBIT (BLANK)</b>	The user attempted to insert-edit an unrecorded part of a tape.
<b>EDIT INHIBIT (NTSC/PAL)</b>	The user attempted editing when PB/DV IN in the SYSTEM (2/2) Menu screen is set to PAL.
<b>EDIT INHIBIT (DV CAM)</b>	The user attempted to edit a tape recorded in the DVCAM format.
<b>EDIT INHIBIT (AUDIO)</b>	The user attempted editing in an audio combination that cannot be edited.
<b>EDIT INHIBIT (DV TC INS)</b>	The user attempted time-code insert-editing during DV signal input.
<b>DV EE INHIBIT</b>	This message is displayed when the REC button is pressed during playback with the INPUT SELECT switch set to DV. (EE check is not allowed during DV input.)
<b>OPERATION LOCK</b>	This message is displayed when an operation button is pressed with OPERATION LOCK enabled. To enable OPERATION LOCK, set OPERATION LOCK in the SYSTEM (2/2) Menu screen to ON.

# ON-SCREEN DISPLAY

- LCD display -

There are two display modes for the status display on the LCD of the unit.

- Same character display mode as the monitor output
- LCD display mode (enlarged display)

DISPLAY button

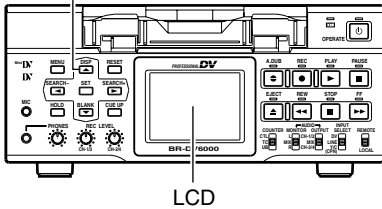

The LCD display mode changes in the following sequence whenever the DISPLAY button is pressed (with DISPLAY of the DISPLAY Menu screen set to ON or AUTO).

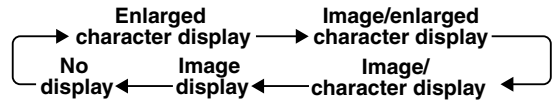







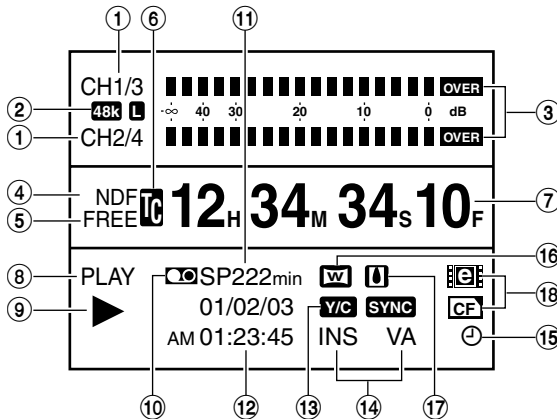













## Memo

- With LCD AUTO OFF in the DISPLAY Menu screen, the LCD display can be set to disappear if it continues to be on for a certain time.  
When the display goes off automatically, press any button to return to the original display mode.
- The LCD display area is smaller compared with the one for the actual images.

## ■ LCD display mode (enlarged display)



<p><b>1 Audio output channel display</b></p> <p>It displays the setting status of the AUDIO OUTPUT switch on the front panel. Top (CH 1 /3 AUDIO OUT): CH 1, CH 3, CH 1 /3 Bottom (CH 2 /4 AUDIO OUT): CH 2, CH 4, CH 2 /4</p>	<p><b>3 Audio level meter display</b></p> <p>It displays the input sound level during recording or in the STOP mode, and the playback sound level during playback. The reference recording level of BR-DV6000 is -20dB.</p> <ul style="list-style-type: none"> <li>• For playing a tape recorded with a home-use DV machine with a reference level of -12 dB, set AUDIO OUT LEVEL to -12 dB.</li> </ul>
<p><b>2 Audio sampling frequency display</b></p> <ul style="list-style-type: none"> <li>• During recording, it displays the setting status of AUDIO MODE of the AUDIO Menu screen. (48k or 32k)</li> <li>• During playback, the audio mode of the tape is displayed (48k, 32k, or 44.1k)</li> <li>• L: Displayed during AUDIO LOCK.</li> </ul>	

<p><b>4 Drop/Non-drop display (for NTSC only)</b></p> <p>Displays the framing mode of the time code.</p> <p>NDF : Non-drop frame  DF : Drop frame  PAL : Displays when PB/DV IN in the SYSTEM (2/2) Menu screen is set to PAL.</p>	<p><b>10 Tape symbol display</b></p> <p>: This symbol is displayed when a cassette tape is loaded.  It blinks during loading or ejecting of a cassette tape.  If the rear switch of the cassette tape is set to SAVE, it is displayed in yellow.</p>
<p><b>5 Time code mode display</b></p> <p>Displays the time code mode set in the TC/UB/CLOCK Menu screen.</p> <p>REGN : Regeneration mode  RRUN : REC RUN preset mode  FREE : FREE RUN preset mode  EXT : This is displayed when time codes are input to the TIME CODE IN terminal (with TCG SOURCE set to EXTERNAL).  It blinks when no time code is input or when the phase of an external time code is not locked with the phase of the video signal.  DUPL : This is displayed when TC DUPLICATE is set to AUTO or NON DROP.  (Enter the time code of the DV terminal.)</p>	<p><b>11 Remaining tape time display</b></p> <p>Displays the remaining time (minutes). Blinks if the remaining time is less than 4 minutes.  Not displayed when the remaining time is being confirmed. SP will not be displayed when a DVCAM cassette tape is being played back.</p>
<p><b>6 Counter mode</b></p> <p>The counter mode selected with the COUNTER switch on the front panel is displayed.</p> <p> : CTL counter       : Time code   : User's bit</p>	<p><b>12 Time/Date display</b></p> <p>The data of the built-in clock will be displayed during recording or in the STOP mode. Displays the data of the tape during playback.  If the date/time is not set up, "---" is displayed.</p>
<p><b>7 Counter display</b></p> <ul style="list-style-type: none"> <li>The CTL counter is displayed as a 7-digit number with + or -.</li> <li>The time code/user's bit is displayed as an 8-digit number.</li> </ul>	<p><b>13 Input video signal display</b></p> <p>Displays the input video signal selected with the INPUT SELECT switch on the front panel.  Blinks if the selected signal is not input (LINE, Y/C, CPNT, or DV).  ( <b>LINE</b>, <b>Y/C</b>, <b>CPNT</b>, <b>DV</b> )  In the case of a copy-prohibiting signal, it will be displayed in yellow.  <b>SYNC</b> : It is displayed when signals are input via the SYNC IN terminal with EXTERNAL SYNC selected.</p>
<p><b>8 VCR mode display</b></p> <p>Displays the operation mode of the VCR.  The reservation of mode is displayed in blinking light.  NOCAS (no cassette tape), EJECT, STBON (standby-on), STBOF (standby-off), PLAY, STILL, FF, REW, SHTL, ADUBP (audio dubbing pause), REC, RECP (recording pause), INSERT, ASSEM, OPOFF (operate off)</p>	<p><b>14 Editing mode display</b></p> <p>The editing mode selected with the editing remote controller is displayed.  (ASSEM, INSV, INSA, INSV A, INS TC, INS VA12, INS VA34, INS A12, INS A34)</p>
<p><b>9 VCR mode graphic display</b></p> <p> : Eject   : Stop   : Play   : Still   : FF/Forward search   : REW/Reverse search:   : Record   : Recording pause   : Audio dubbing   : Audio dubbing pause</p>	<p><b>15 Timer display</b></p> <p> : It is displayed when the TIMER switch on the rear panel is set to REC or PLAY.  REC: RED      PLAY: GREEN</p>
	<p><b>16 Wide screen ID signal display</b></p> <p> : It will be displayed when a wide screen ID signal exists in the input signal of the Y/C or DV terminal.  The data on the tape is displayed during playback.</p>
	<p><b>17 Condensation display</b></p> <p>: It is displayed when condensation occurs.</p>
	<p><b>18 Option display</b></p> <p>It is displayed when an option board is connected.</p> <p>: SA-X61U connection  : SA-X62U connection  : SA-DV6000 connection</p>

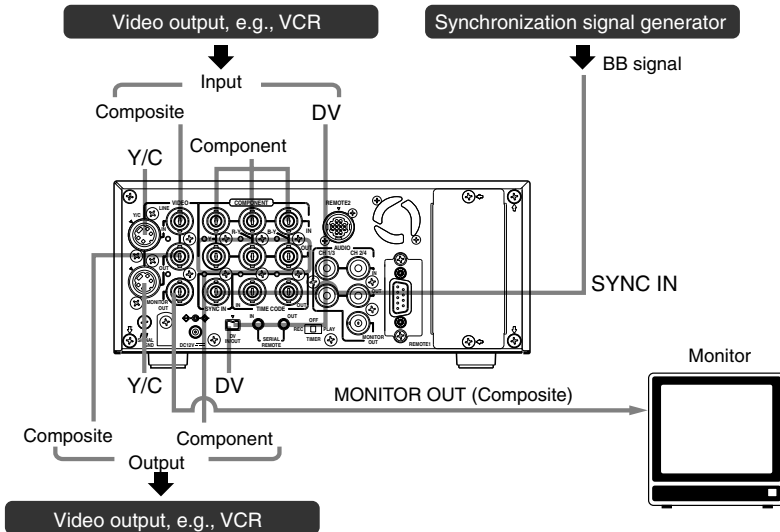

### ■ Output signal

When BR-DV6000 enters the STOP, REC or EDIT mode, the input signal (E-E image) is output. In the PLAYBACK mode (including the playback of the pre-roll part during editing), playback images are output.

However, in the edit mode with analog input, signals cannot be output to the DV OUT terminal properly.

#### ● Analog signal

- LINE OUT terminal (BNC): composite signal.
- Y/C OUT terminal (4-PIN): YC separate signal.

When a wide screen ID signal exists in the video signal, the ID signal is output.

- COMPONENT OUT terminal (BNC × 3): Component (Y/B-Y/R-Y) signals are output. The output level is of  $\beta$  cam (HIGH).

#### ● Digital signal

- DV IN/OUT terminal: it outputs IEEE1394-compliant digital video signals.

When a wide screen ID signal exists in the video signal, the ID signal is output.

#### ● Connection with a monitor TV

A monitor TV can be connected to the MONITOR OUT terminal. Besides the composite video signals, it also displays the on-screen display for status or menu screen.

#### Memo

Set PB/DV IN in the SYSTEM (2/2) Menu screen according to the signal format of the tape to be played. (NTSC or PAL)

### ■ Input signal

The input video signal is selected with the INPUT SELECT switch on the front panel. Set VIDEO INPUT SEL in the VIDEO Menu screen to select YC input or component input.

#### ● Analog signal

- LINE IN terminal (BNC): composite signal
- Y/C IN terminal (4-PIN): YC separate signal  
When a wide screen ID signal is being input, the ID signal is recorded.
- COMPONENT IN terminal (BNC × 3):  
The component (Y/B-Y/R-Y) signal.  
The output level is of  $\beta$  cam (HIGH).

#### ● Digital signal

- DV IN/OUT terminal : IEEE1394-compliant digital video signals are input.

When a wide screen ID signal is being input, the ID signal is recorded.

Set PB/DV IN in the SYSTEM (2/2) Menu screen according to the signal format to be input to the DV terminal. (NTSC or PAL).

#### Memo

Whether or not to enable SET UP for analog I/O signals of signals can be selected with SET UP in the VIDEO Menu screen (for NTSC only).

## Caution on video signals

- If search images or video signals with a high level of jitter are input, images or sound may be distorted temporarily. Thus, input stable signals, e.g., those having gone through a TBC.
- A digital VCR requires that video signals for recording be delivered from a stable source. Video signals from an analog VCR must be run through a TBS or TBC.
- When a component output is executed for composite-input video, discoloration may occur on the left side of the screen. It is not a defect.

## ■ Synchronization signal

In order to enhance the level of edit precision, input synchronization signals to all the devices of the editing system during editing.

For BR-DV6000, input external synchronization signals into the SYNC IN terminal. For external synchronization signals, use video signals of 1V (p-p) or lower (e.g., black burst signals).

To edit DV signals, synchronization signal input is required.

### Types of synchronization signal:

BR-DV6000 is operated based on one of the following 3 types of synchronization signal.

- Synchronization signals produced by the synchronization signal generator inside the VCR (INT)
- Video signals from the video signal input terminal (VIDEO)
- Synchronization signals from the SYNC IN terminal (EXT)

### Selection of synchronization signals:

Synchronization signals should be selected depending on whether external synchronization input (SYNC IN) or video input (VIDEO IN) exists or on the SYNC SELECT Menu settings. Synchronization signals are selected as shown in the following table.

SYNC IN		No	Yes	No	Yes
VIDEO IN		No	No	Yes	Yes
EXTERNAL*	Playback	INT	EXT	INT	EXT
	Record	INT	INT	VIDEO	VIDEO
AUTO*	Playback	INT	EXT	VIDEO	EXT
	Record	INT	INT	VIDEO	VIDEO

\* The above can be selected with SYNC SELECT in the SYSTEM Menu screen.

## Memo

- During DV signal recording, the status of synchronization signals will be as shown below regardless of the SYNC SELECT menu settings.

SYNC IN terminal signal	Synchronization signals
Input	EXT
No input	DV

- Regardless of the setting of SYNC SELECT, when a tape recorded in PAL is played back, synchronization signals are as shown below.

SYNC IN terminal	Synchronization signals
PAL signal input	EXT
NTSC signal input or No signal input	INT

## Caution on synchronization signals

- For external synchronization signals, output-signal phase adjustments cannot be performed. In addition, the sub carrier cannot be locked.
- Plugging and unplugging of external synchronization signals or video input signals during playback causes distortion of images and sound for about 5 seconds.

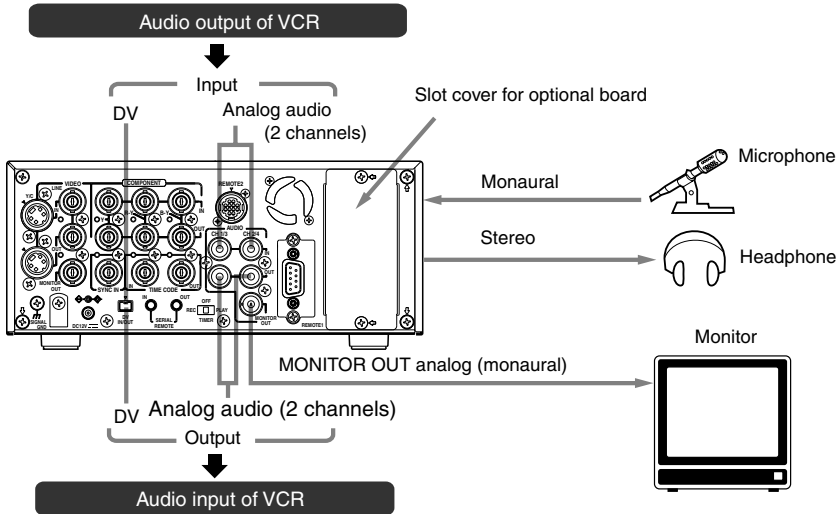

### ■ Output signal

When BR-DV6000 is in the STOP, REC or EDIT mode, signals (EE sound), which have been input, are output.

During the PLAYBACK mode (including the playback of the pre-roll part during editing), the playback sound is output.

However, in the edit mode with analog input, signals cannot be output to the DV OUT terminal properly.

### ● Analog signal

CH 1/3, CH 2/4 AUDIO terminal (RCA × 2).

There are analog audio terminals for 2 channels.

For the DV format, tracks are available for 4 channels (in the 32kHz audio mode).

- In the 32kHz mode, from which one of the 4 channels sound is output can be selected with the AUDIO OUTPUT switch on the front panel. (Refer to the table on the right.)

### ● Headphone terminal

Sound can be checked in stereo using a headphone. The volume can be adjusted with the PHONES switch on the front panel.

- The channel to be output from this terminal in the 32kHz audio mode can be selected with the AUDIO OUTPUT switch. (Refer to the table on the right.)

### AUDIO OUTPUT switches and output channels

In the following cases, the channels that receive output from the AUDIO OUTPUT terminal vary according to the setting of the AUDIO OUTPUT switch. The table below shows the channels.

- During playback of tapes recorded in the 32kHz audio mode.
- During audio dubbing.
- In the EE mode of DV input in the 32kHz audio mode.

AUDIO OUTPUT switch	AUDIO OUT terminal	
	CH1/3 (L)	CH2/4 (R)
CH1/2	CH1	CH2
MIX	CH1/3	CH2/4
CH3/4	CH3	CH4

- In the 48kHz audio mode or during normal recording, output goes to CH1 and CH2 regardless of the setting of the switch.

● **Connecting to a monitor TV**

A monitor TV can be connected to the AUDIO MONITOR OUT terminal.

The sound output from the AUDIO MONITOR OUT terminal is monaural.

- The volume is adjusted through the monitor TV.
- The output channel can be selected with the AUDIO MONITOR switch on the front panel (Refer to the following table).

**AUDIO MONITOR switches and output channels of AUDIO OUTPUT/PHONES**

In the following cases, the output channels from the AUDIO MONITOR OUTPUT/PHONES terminal vary according to the setting of the AUDIO MONITOR switch and the AUDIO OUTPUT switch. The table below shows the channels.

- During playback of tapes recorded in the 32kHz audio mode.
- During audio dubbing.
- In the EE mode of DV input in the 32 kHz audio mode.

AUDIO switch		MONITOR OUT/ PHONES terminal
MONITOR	OUTPUT	
L	CH1/2	CH1
	MIX	CH1/3
	CH3/4	CH3
MIX	CH1/2	CH1/2
	MIX	CH1/2/3/4
	CH3/4	CH3/4
R	CH1/2	CH2
	MIX	CH2/4
	CH3/4	CH4

- In the 48kHz audio mode or during normal recording, it outputs to CH1/2 channel (the OUTPUT switch listed in the above table shows the setting of CH1/2).
- When MIX is selected, the PHONES terminal outputs stereo sound.

● **Digital output**

IEEE1394-compliant digital signals are output from the DV IN/OUT terminal.

■ **Input signal**

● **Analog signal**

CH 1/3 AUDIO IN terminal. (RCA×2)

There are analog input terminals for 2 channels. Recording cannot be performed to 4 channels at the same time. Sound from each terminal is usually recorded to CH1 and CH2.

To record to CH 3 and CH 4, set AUDIO MODE of the AUDIO Menu screen to 32 k and record it in the audio-dubbing mode. (Page 44)

● **Microphone input terminal**

This terminal is for connecting to a monaural microphone. The same sound is recorded on the 2 channels.

**Memo**

- To record sound on the AUDIO IN terminal and MIC terminal, set the INPUT SELECT switch on the front panel to "LINE" or "Y/C (CPN)".
- If the AUDIO IN terminal and MIC terminal are used at the same time, the MIC terminal precedes.

● **Digital input**

IEEE1394-compliant digital signals are input into the DV IN/OUT terminal.

- To enable audio input into this terminal, set the INPUT SELECT switch to DV.
- The AUDIO MODE (48 K or 32 K) will be one of input signals.
- During digital signal input, the recording level cannot be adjusted.

**Memo**

- An input/output board (sold separately) of the XLR connector can be installed in the optional slot.  
SA-X61U AUDIO XLR IN board  
SA-X62U AUDIO XLR OUT board  
These boards cannot be installed at the same time.
- For BR-DV600 player, when the mode is changed from STILL to PLAY, sound will be muted for a while shortly after the audio output. Thereafter, it will resume as per normal. (This does not occur with BR-DV600A.)

# CONNECTION

## - Connecting to editing system -

BR-DV6000 is equipped with 2 remote terminals, for the JVC bus and RS-422A for editing purposes.

### ■ When a JVC bus-compatible editing remote controller is used:

For the editing remote controller, use RM-G800 or RM-G805.

Example: BR-DV6000 as player and recorder for cut editing of digital signals.

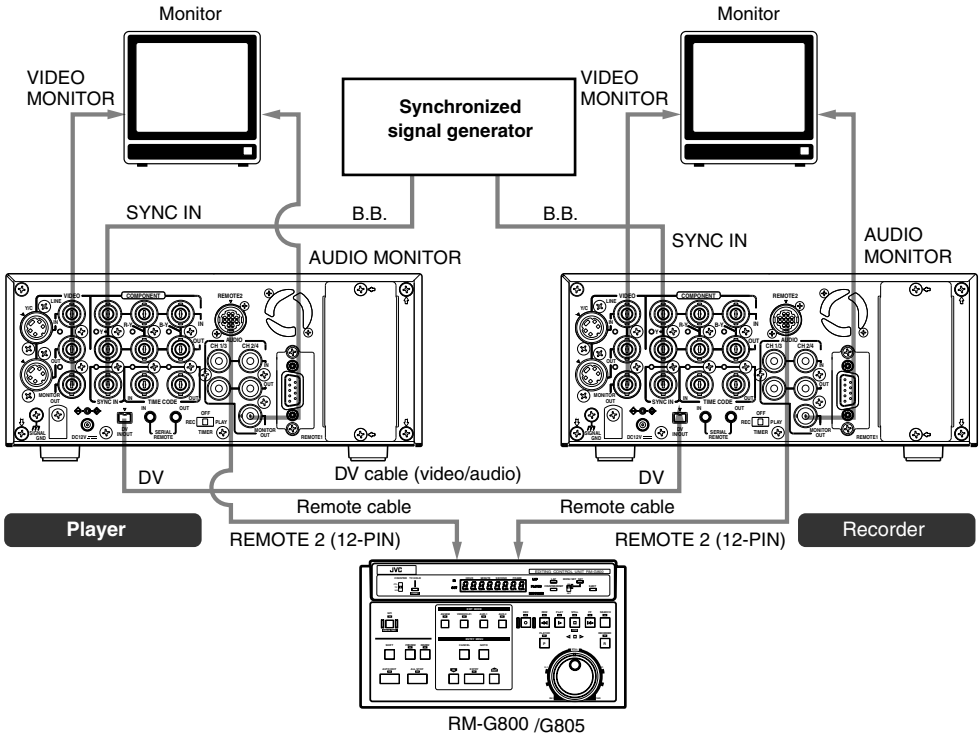

### Note

Before connecting the cables for remote terminals, ensure that the power to the VCR is turned off.

### ■ Remote extension cable

To extend the cables for the remote terminals, use the extension cable VC-G8030U (3m) (sold separately).

### ■ DV cable

Use VC-VDV204 (2 m, 4P-4P) or VC-VDV206 (2 m, 4P-6P) (sold separately).

### ■ Related VCRs

#### ● VHS/S-VHS VCR

No input/output of DV signals is possible.  
BR-S800 + (SA-N50)  
BR-S500 (player) + (SA-N50)

#### ● DV VCR

BR-DV600/A

### Note

- If RM-G800 is to be used, check whether the (x) mark is printed on the label at the bottom of the unit.  
If there is no (x) mark, modification is required. Consult your JVC service agent.
- For the use of RM-G800/G805, there are certain regulations regarding Electro-Magnetic Compatibility (EMC). Consult your JVC service agent.



■ **When an RS-422A-compatible remote controller is used:**

For the editing remote controller, use RM-G820.

Example: use BR-DV6000 as player and recorder for cut editing of analog signals.

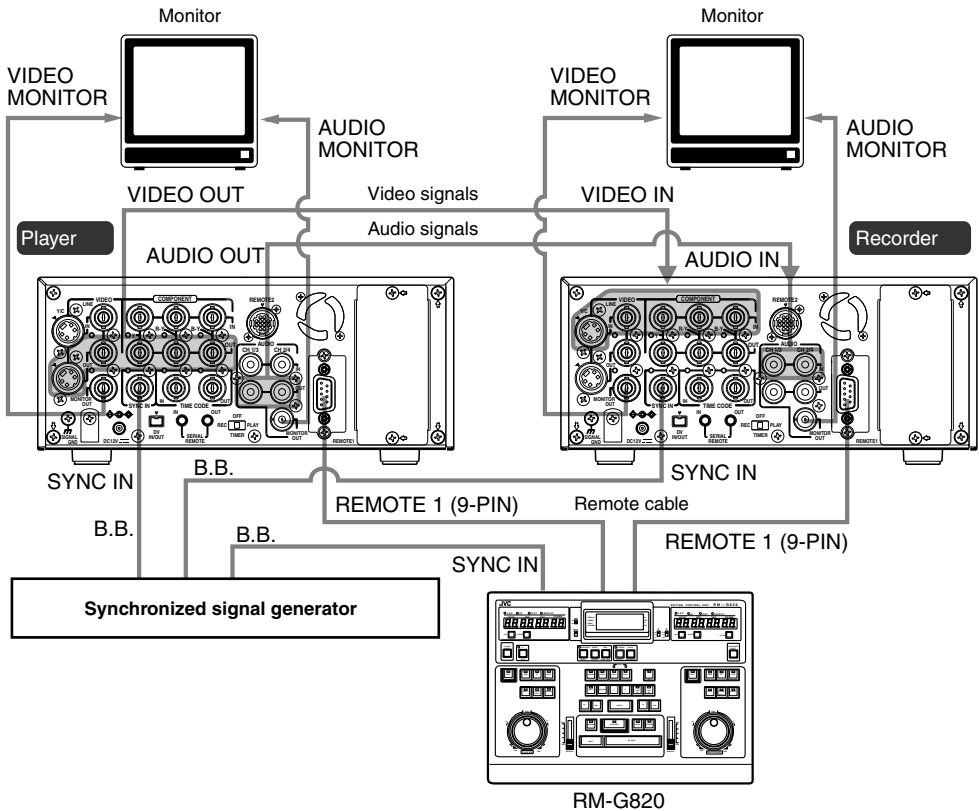

■ **To fasten the connector of the remote cable to the REMOTE 1 terminal, use a screw of the inch, not metric, system.**

■ **In order to enhance the level of editing precision, input synchronization signals (black burst signals) to all devices.** (☞ Page 29)

When BR-DV3000 is to be used as the player, input as synchronization signals the composite signals or the Y signals of the YC signals of BR-DV3000 to the SYNC IN terminal of BR-DV6000.

■ **Related VCRs**

- **VHS/S-VHS VCR**  
BR-S800 (equipped with SA-K26, SA-R50, SA-N50)  
BR-S822 (equipped with SA-T22)  
\* No input/output of DV signals is possible.
- **D-9 (digital S) VCR**  
BR-D80, BR-D85, BR-D750  
(Only analog signals)
- **DV VCR**  
BR-DV3000 (player only)  
BR-DV600/A (player only)

**For information on settings and other points on the operation of BR-DV6000 with an editing system, refer to pages 64 – 68.**

# CONNECTION - Connection with serial remote terminals -

The following describes examples of serial remote terminal connection.

To use the serial remote terminals, set REMOTE SEL SER of the REMOTE (1/2) Menu screen to "ON" or "LOC+REM." (Page 75)

## ■ Operate BR-DV6000 with the wired remote controller RM-G30 (sold separately)

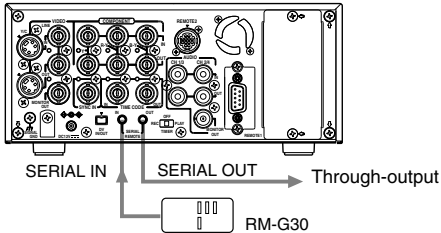

Connect the wired remote controller RM-G30 to the SERIAL REMOTE IN terminal.

The commands of the SERIAL REMOTE IN terminal is through-output from the SERIAL REMOTE OUT terminal. (Only with OPERATE ON)

Multiple VCRs can be operated with RM-G30 by series connection of the SERIAL REMOTE IN/OUT terminals.

## ■ Start/stop recording with an external switch, e.g., a foot switch.

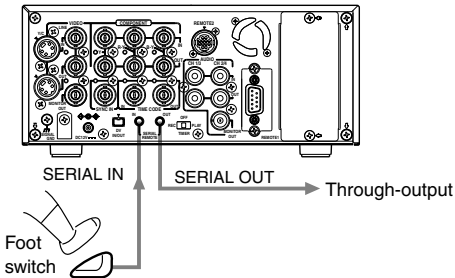

Connect an external switch, e.g., a foot switch, to the SERIAL REMOTE IN terminal.

The format of the input signals can be selected with FOOT SW in the REMOTE (2/2) Menu screen. (Page 46)

## ■ Dubbing of playback images or sound with other machines using the SERIAL REMOTE OUT terminal.

When BR-DV6000 is in the playback mode, the REC command can be output from the SERIAL REMOTE OUT terminal (REPLICATION function). With this function, a tape loaded in BR-DV6000 can be dubbed on another unit. For details, refer to Page 57. BR-DV6000 can be used as a master or dubbing unit.

### ● Dubbing with 1 VCR.

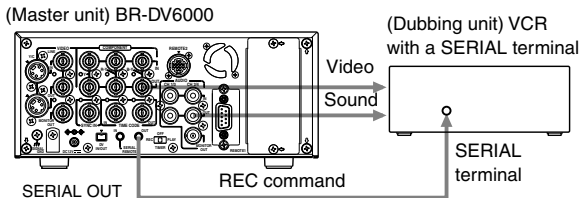

### Memo

If REPLICATION of the SYSTEM (2/2) Menu screen is set to DV, the REC command is output from the DV terminal.

### ● Dubbing with multiple VCRs (Up to 50 VCRs can be controlled comprehensively.)

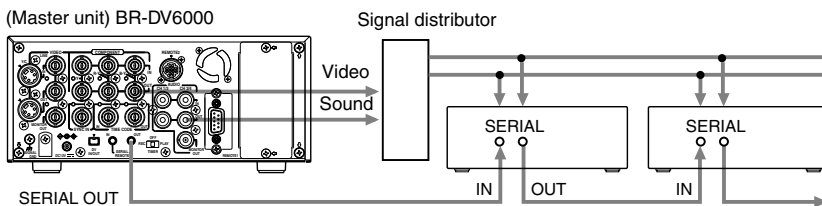

\* Dubbing unit: VCR with SERIAL IN and OUT terminals  
DV: BR-DV6000

# CONNECTION

## - Connecting the AC adaptor -

Connect the supplied AC adaptor to BR-DV6000.

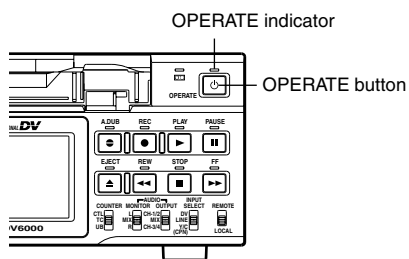
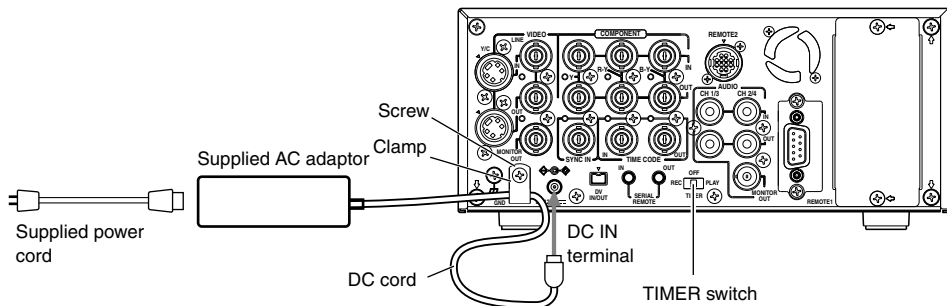

■ Before connecting the AC adaptor, ensure that the TIMER switch is set to “OFF”. (Refer to “Notes” below.)

1. Connect the DC cord of the AC adaptor to the DC IN terminal of BR-DV6000.

2. To prevent accidental disconnection of the DC cord, fasten the DC cord with a clamp.

- ① Remove the screw and the clamp shown in the above figure.
- ② Insert the DC cord into the clamp and fasten the clamp unto the unit.

3. Connect the supplied power cord to the AC IN terminal of the AC adaptor.

4. Connect the power cord to the power outlet.

- BR-DV6000 is turned on and the OPERATE indicator lights up in red. (OPERATE OFF mode)
- If DC IN MODE of the SYSTEM (2/2) Menu screen is set to “OPE ON”, the OPERATE indicator will light up in green. (OPERATE ON mode)

### Memo

- Even in the OPERATE OFF mode, a small amount of electricity will still flow into the unit.
- When the unit is in the OPERATE OFF mode, no operation can be performed except that of the OPERATE buttons and cassette loading/ejecting.

### Notes

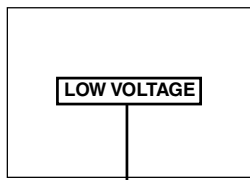

Alarm message

- Supply power to BR-DV6000 using the supplied AC adaptor. Do not use other power sources.
- Do not unplug the DC cord and/or the power cord during recording or playback.
- If the supply voltage is low, an alarm display of “LOW VOLTAGE” is shown.
- If the TIMER switch is set to REC or PLAY, recording or playback begins when power is supplied to the DC IN terminal. When the AC adaptor is connected, ensure in particular that the TIMER switch is not set to REC. Set the TIMER switch to REC or PLAY only when an external timer function is used.

# PREPARATION

## - Turning on/off the power -

### Turning on the power

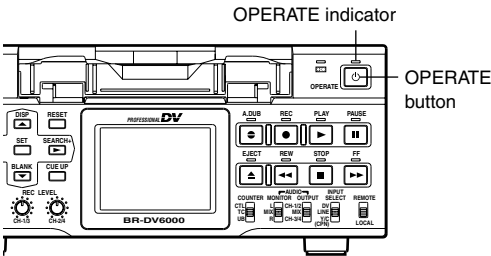

- Press the **OPERATE** button when BR-DV6000 is in the **OPERATE OFF** mode (with the **OPERATE** indicator lit up in red)

- The power is turned on and the **OPERATE** indicator lights up in green. BR-DV6000 is ready for operation. (**OPERATE ON** mode)

#### Note

After the **OPERATE** button is pressed and BR-DV6000 is turned on, if the green indicator blinks or the monitor or the LCD displays “UN-PLUG MAIN POWER, PLUG BACK IN AFTER A WHILE”, unplug the power cord from the power outlet, leave it for a while before turning on the power again.

#### Memo

- In the **OPERATE OFF** mode, if a cassette tape is inserted, the power is turned on and BR-DV6000 goes into the **OPERATE ON** mode.
- Whether BR-DV6000 goes into the **OPERATE ON** or **OFF** mode when the power is supplied to the DC IN terminal can be selected with DC IN MODE in the **SYSTEM (2/2)** Menu screen.
- If **TIMER REC** or **TIMER PLAY** is selected, BR-DV6000 starts up in the **OPERATE ON** mode regardless of the DC IN MODE Menu settings. If a cassette tape is loaded, BR-DV6000 starts recording or playback.

### Turning off the power

- Turn off BR-DV6000

#### 1. Press the **OPERATE** button.

- BR-DV6000 enters the **OPERATE OFF** mode and the **OPERATE** indicator lights up in red.

#### 2. If BR-DV6000 is not to be used for a long period of time, unplug the AC adapter.

- To unplug the AC adapter, remove the power cord from the power outlet first.

# PREPARATION

## - Operation method (main unit/ remote controller) and operation lock mode -

### Selecting the operating method (main unit/remote controller)

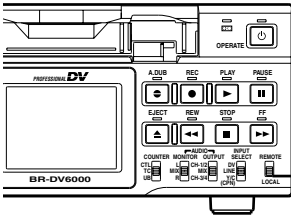

Whether to operate BR-DV6000 with its buttons or the remote controller can be selected with the REMOTE/LOCAL switch.

#### Setting the REMOTE/LOCAL switch

- To operate with the buttons of BR-DV6000, set it to "LOCAL".
- To operate BR-DV6000 with RS-422A or JVC-bus editing remote controller that is connected to the REMOTE 1 (9-PIN) or REMOTE 2 (12-PIN) terminal, set it to "REMOTE".

#### REMOTE (1/2) Menu screen

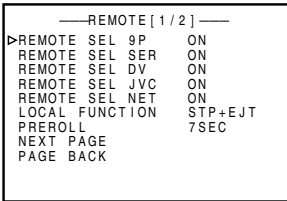

#### Memo

With the REMOTE/LOCAL switch set to REMOTE, the JVC bus or RS-422A can be enabled using REMOTE SEL JVC or REMOTE SEL 9P in the REMOTE (1/2) Menu screen.

- The setting position of the REMOTE switch for operating BR-DV6000 with the SERIAL REMOTE terminal can be selected using REMOTE SEL SER in the REMOTE (1/2) Menu screen.
- The setting position of the REMOTE switch for operating BR-DV6000 with the DV terminal can be selected at REMOTE SEL DV in the REMOTE (1/2) Menu screen.

[Page 75 "REMOTE (1/2) Menu screen"]

#### Memo

If the REMOTE/LOCAL switch is set to REMOTE, the buttons that can be operated by the main unit can be selected with LOCAL FUNCTION.

## OPERATION LOCK mode

BR-DV6000 comes with an operation lock function to prevent unauthorized or incorrect operation. In the OPERATION LOCK mode, the operation buttons and slide switches of BR-DV6000 are disabled. However, the OPERATE ON and MENU operations are effective.

The AUDIO MONITOR switch, TIMER switch, PHONES volume and REC LEVEL volume are always effective.

#### SYSTEM (2/2) Menu screen

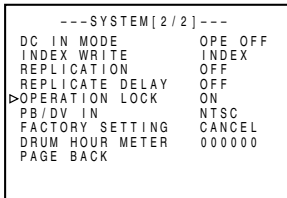

#### Turning on the OPERATION LOCK mode

Set OPERATION LOCK in the SYSTEM (2/2) Menu screen to ON.

- If the operation button of BR-DV6000 is pressed while BR-DV6000 is in the OPERATION LOCK mode, "OPERATION LOCK" is displayed on the monitor or the LCD for about 3 seconds.

#### Turning off the OPERATION LOCK mode

Set OPERATION LOCK in the SYSTEM (2/2) Menu screen to OFF.

# PREPARATION

## - Loading/Ejecting cassette -

Use standard DV cassette tapes or mini DV cassette tapes.

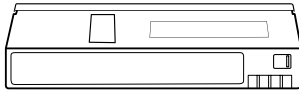
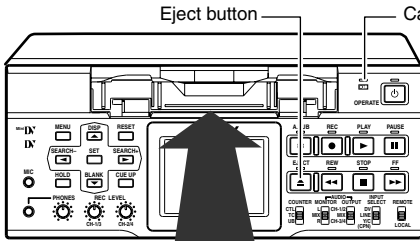

Standard DV tape

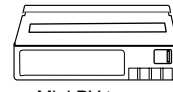
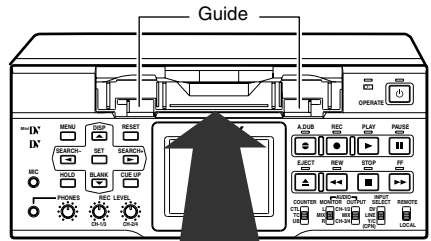

Mini DV tape

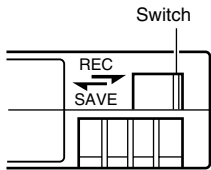

### Loading the cassette tape

#### 1. Check the cassette tape.

- Setting the rear switch.  
Push it to "REC" for recording.  
To prevent its contents from being erased accidentally, push it to "SAVE".
- Ensure that the tape is not loosened.

#### 2. Ensure that no cassette tape is loaded.

With no cassette tape loaded, the cassette LED is off.  
When no cassette tape is loaded, the status display for the VCR operation mode shows "NO CASSETTE" on the monitor or the LCD.

#### 3. Load the cassette tape.

- Insert a standard DV cassette tape into the tape-loading slot.
- For a mini DV cassette tape, load it in between the left and right guides.  
Set the tape window face up and push the cassette tape in slowly until it is drawn in automatically.  
→ When the cassette tape is loaded, the status display indicates "STANDBY-ON".
- ✦ If the STANDBY-ON mode is left as is, it goes into the STANDBY-OFF mode.  
In the STANDBY-OFF mode, press the STOP button to return to the STANDBY-ON mode.

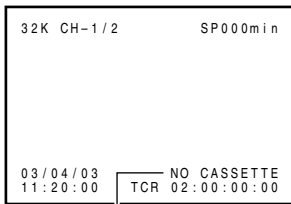

VCR mode status display

#### Memo

- The cassette tape can be loaded/ejected even when BR-DV6000 is in the OPERATE OFF mode.
- The loading/ejecting action of the cassette tape takes about 6 seconds.

### Ejecting the cassette tape

#### 1. Press the EJECT button of BR-DV6000.

→ While the cassette tape is being ejected, the status display flashes "EJECT".

#### 2. Remove the cassette tape.

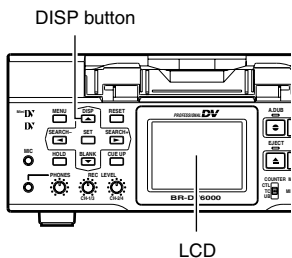

### ■ Selecting the LCD status display

The contents of the status display for the LCD are selected with the DISP button located on the front panel.

When the DISP button is pressed, the status display changes in the following sequence.

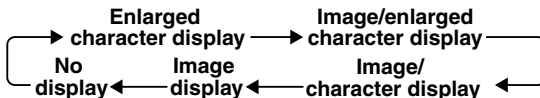

(☞ Page 20 “On-screen display”)

(☞ Page 26 “LCD display”)

### ■ The LCD settings are performed in the DISPLAY (1/2) Menu display.

#### ● Adjusting the LCD display

- Brightness : With LCD BRIGHTNESS
- Color depth : With LCD CHROMA.
- Contrast : With LCD CONTRAST.

Each of the above can be set up in 11 levels.

#### ● Setting the display time of the LCD display

If the LCD display is not to be used for a long time, LCD AUTO OFF can be selected to set the time for the LCD to go off automatically.

- OFF : Does not turn off automatically.
- 30MIN : Turns off automatically after 30 minutes.
- 1HOUR : Turns off automatically after 1 hour.
- 2HOUR : Turns off automatically after 2 hours.

#### DISPLAY (2/2) Menu screen

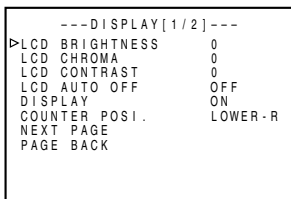

#### Memo

- During recording or playback, the LCD display stays on regardless of the LCD AUTO OFF setting.
- After the LCD display was turned off automatically, press any button to restore the original display.

# PREPARATION

## - Setting/Displaying date and time -

This function sets up the date and time of the built-in clock. With the built-in chargeable battery, the date and time data that have been set are maintained even after the main power is turned off. The set date and time data are displayed on the monitor or the LCD display according to the settings in the Menu screen. Set DATE REC in the TC/UB/CLOCK (2/2) screen to ON if the date/time display is to be recorded on the tape as video signals. With DV signal input, date/time data are not recorded. (Page 42 "Setting date/time recording")

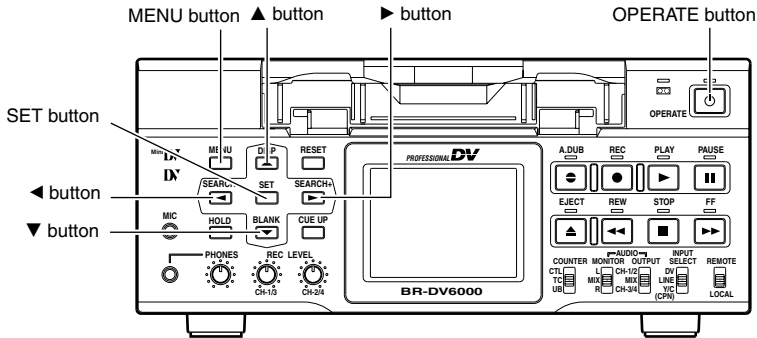

### Setting date and time

The date and time are set up at the CLOCK ADJUST Menu screen.

The CLOCK ADJUST Menu screen is found under the TC/UB/CLOCK (2/2) Menu.

Setting can be performed while checking the information shown on the monitor connected to the VIDEO MONITOR OUT terminal.

#### TC/UB/CLOCK (2/2) Menu screen

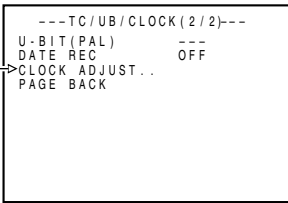

Cursor

#### CLOCK ADJUST Menu screen

Date (MM/DD/YY)

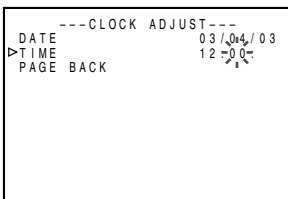
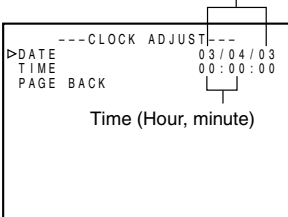

■ Press the OPERATE button to turn on the power and set it to the STOP mode.

1. Press the MENU button to display the TOP MENU screen.

2. Displaying the CLOCK ADJUST Menu.

- ① Press the ▲ or ▼ button to bring the cursor to the desired TC/UB/CLOCK item. Press SET or the ► button.
- ② Press the ▲ or ▼ button to bring the cursor to the NEXT PAGE item in the TC/UB/CLOCK (1/2) Menu screen. Press SET or the ► button.
- ③ Press the ▲ or ▼ button to bring the cursor to the CLOCK ADJUST item in the TC/UB/CLOCK (2/2) Menu screen. Press SET or the ► button.

3. Setting the date and time in the CLOCK ADJUST Menu screen.

- ① Press the ▲ or ▼ button to bring the cursor to the date or time item. Press SET or the ► button.
- ② Press the ► or ◀ button to select the digit for setting. The selected digit starts blinking.
- ③ Press the ▲ or ▼ to set the value.
- ④ Repeat step ① - ③. After completing the required setting, press the SET button.



## Memo

The seconds for the time cannot be set up. After the minute is set up, press the SET button in synchronization with the time signal.

```
---CLOCK ADJUST---
DATE          03/04/03
TIME          12:00
▷PAGE BACK
```

### 4. Returning to the TOP MENU from TC/UB/CLOCK after completing all settings

- Press the ◀ button.  
Or  
Press the ▲ or ▼ button to bring the cursor to PAGE BACK and press the SET button.

### 5. Returning to the usual menu

- Press the MENU button.  
Or  
Bring the cursor to EXIT of the TOP MENU and press the SET button.

## Selecting date/time display

The date and time data can be displayed on the monitor or LCD on-screen display (status display). Setup can be performed at the DISPLAY (2/2) Menu screen to turn on/off the date/time display and select the display style. (For setting procedure:  Page 70)

### DISPLAY (2/2) Menu screen

```
---DISPLAY[2/2]---
TIME CODE      ON
VTR MODE       ON
TAPE REMAIN    ON
▷TIME/DATE     DATE+TM
AUDIO INFO.    ON
EDIT INFO.     ON
DATE STYLE     MM/DD/YY
TIME STYLE     24HOUR
PAGE BACK
```

### ■ DISPLAY (2/2) Menu screen

#### • TIME DATE : For enabling/disabling the display of date and time on the status display

OFF : Does not display date/time.

TIME : Displays time only.

DATE : Displays date only.

DATE+ TM : Displays both the time and date.

#### • DATE STYLE: For selecting the date display style

YY/MM/DD : Year / month / day

MM/DD/YY : Month / day / year

DD/MM/YY : day / month / year

#### • TIME STYLE: For selecting the time display style

24H : 24-hour time mode

12H : 12-hour time mode

These setting items are also reflected in the date/time record (DATE REC function).

## On-screen status display

Set DISPLAY to ON or AUTO in the DISPLAY (1/2) Menu screen.

### On-screen status display

```
32K CH-1/2          SP000min

03/04/03          STANDBY-OFF
12:00:00          TCR 02:00:00:00
```

Date/time display

## Memo

- In the RECORDING or STOP mode : Displays the time of the built-in clock.
- In the Playback mode : The date and time recorded on the tape are displayed.
- In the DV recording mode : The date and time from the DV terminal are displayed.

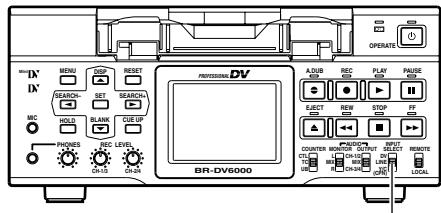

INPUT SELECT switch

## ■ Selecting input signal

Select the signal with the INPUT SELECT switch located on the front panel.

**DV** : For inputting DV signals (video and audio)

**LINE** : For inputting composite video and analog sound signals

**Y/C (CPN)** : For inputting Y/C separate signals or component signals for video. The type of signal to input can be selected with VIDEO INPUT SEL of the VIDEO Menu.

For sound, analog signals are input.

### Memo

- For analog audio signals, if the AUDIO IN terminal and MIC terminal are used at the same time, the MIC terminal precedes.
- Audio signals are recorded on CH1 and CH2.
- Analog signals cannot be recorded when PB/DV IN is set to PAL. In such a case, recording is not possible.
- For DV signal input, the AUDIO MODE setting cannot be performed. It will be the same mode as that of the input signal (48 K or 32 K).

## ■ Settings the VIDEO Menu (☞ Page 79)

### ● SET UP (only for NTSC)

Set here according to the existence of the setup of analog video signals (composite, YC separate and component). If it exists, set here to ON. If it does not, OFF.

### ● BLACK BURST

Set BLACK BURST to ON to record the black burst signals (black screen) of the built-in signal generator.

(When analog input is selected)

## ■ Settings of the AUDIO menu (☞ Page 78)

### ● AUDIO MODE

This is for selecting the audio sampling frequency for recording.

**32 K**: Recording in the 32 kHz mode. Select 32 K when performing audio dubbing on CH3 and CH4.

**48 K**: Recording in the 48 kHz mode. Audio dubbing is not available.

### ● AUDIO INPUT SEL (Displayed only when an optional board is installed)

This setting is required with XLR IN board SA-X61U (sold separately) installed. Set this item to XLR for selecting the audio input terminal of the XLR IN board.

## ■ Setting the SYSTEM Menu (☞ Page 73)

### ● LONG PAUSE TIME

This is for setting the time for BR-DV6000 to enter the tape protection mode if there is a long recording pause.

### ● INDEX WRITE: SYSTEM (2/2) Menu

This is for selecting whether to record index signals automatically when recording starts.

### ● PB/DV IN: SYSTEM (2/2) Menu

For recording NTSC signals, set this item to NTSC.

For recording PAL signals from the DV terminal, set this item to PAL.

## ■ Setting the time code recording for DV signal input

Select data from the built-in time code generator or from the DV terminal with TC DUPLICATE in the TC/UB/CLOCK (1/2) Menu screen. (☞ Page 80)

## ■ Setting date/time recording

Perform setting for the following items.

- Set DATE REC in the TC/UB/CLOCK (2/2) Menu screen to ON.
- Set DISPLAY in the DISPLAY (1/2) Menu screen to ON.
- Set TIME/DATE in the DISPLAY (2/2) Menu screen to any setting item except OFF.

The same data as on the date/time on-screen display are added to the image and recorded.

### Memo

With DV signal input, data of the built-in clock are not recorded.

If video signals are input from the DV terminal, the date/time data from this terminal are recorded regardless of the menu settings.

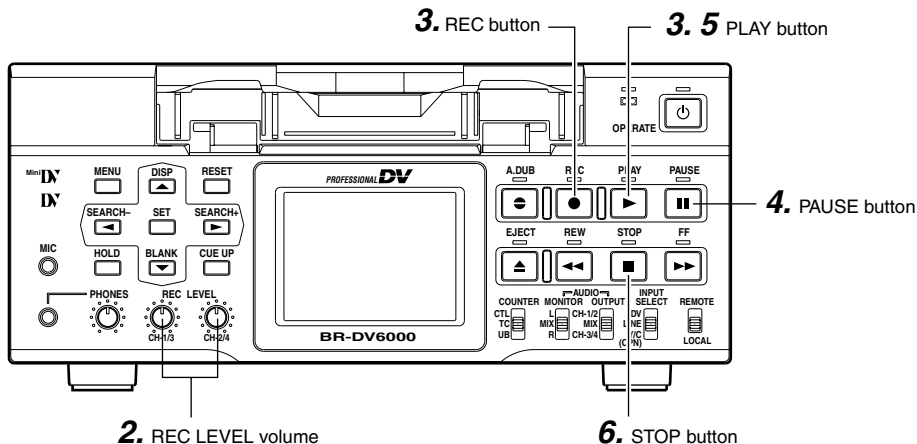

### Memo

- The tape protection function enables BR-DV6000 automatically to go into the STOP mode when there is a long recording pause. The time to go into the STOP mode can be set with LONG PAUSE TIME in the SYSTEM (1/2) Menu screen.
- When a home-use DV VCR is used to play tapes recorded with BR-DV6000, the sound level may be reduced.

### 1. Load the cassette tape.

- Before loading the cassette tape, please ensure that the rear slide of the cassette tape is pushed to REC.  
→ The unit is turned on.

### 2. Adjust the audio recording level.

- Adjust the REC LEVEL volume. Adjust it such a way that, with the maximum volume, the audio level meter does not display OVER.
- \* During DV input, the REC LEVEL volume cannot be adjusted.

### 3. Start recording.

- Press the PLAY button while holding down the REC button.

### 4. Pause recording.

- Press the PAUSE button.

### 5. Resume recording.

- Press the PLAY button.

### 6. Stop recording.

- Press the STOP button.

## Recording index signals

If INDEX WRITE is set to ON in the SYSTEM (2/2) Menu screen, an index signal is recorded at the recording starting position of the tape. In the PLAYBACK mode, the position where the index signal is recorded can be searched. (Index search)

### Memo

If recording is performed right after the RECORDING PAUSE mode is exited, index signals are not recorded.

### ■ Press the REC button to record index signals during recording

- \* It is not possible to record only index signals after the recording. Allow at least an interval of 1 minute between recordings of index.
- \* Index signals cannot be recorded with the REC button of the remote controller. Use the record button of BR-DV6000.

For tapes recorded in the 32 kHz audio mode, audio dubbing can be performed on CH3 and CH4 after the recording. (After-recording)

### Notes

- For tapes recorded in the 48 kHz audio mode, audio dubbing cannot be performed.
- Audio dubbing cannot be performed for DV input signals.

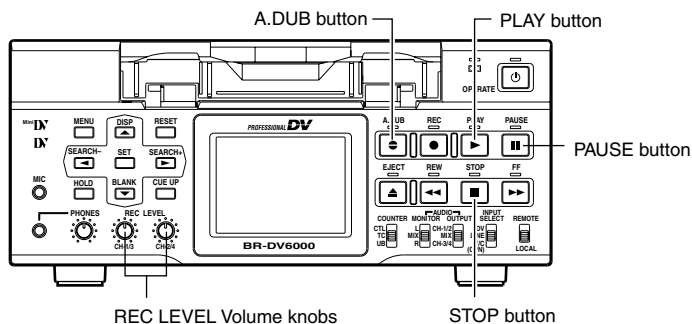

### Connection

Audio dubbing sounds are input from the AUDIO IN terminal on the rear panel or the MIC terminal on the front panel. MIC terminal prevails over the AUDIO IN terminal.

### Setting

- Set AUDIO MODE in the AUDIO Menu screen to "32 K."
- Do not set the INPUT SELECT switch on the front panel to "DV."

### Operation

- 1. Press the PLAY button to play the tape.**
- 2. At the position where you wish to perform audio dubbing, press the PAUSE button.**  
→ The unit enters the STILL mode.
- 3. Press the PAUSE button while holding down the A.DUB button.**  
→ The unit enters the AUDIO DUBBING PAUSE mode.
- 4. Adjust the audio recording level.**  
Recording level of the sound to be audio-dubbed can be adjusted with the REC LEVEL Volume knobs.
- 5. Press the PLAY button.**  
→ Audio dubbing begins. Audio signals are recorded on CH3 and CH4.
  - To stop audio dubbing temporarily, press the PAUSE button.
- 6. To end audio dubbing, press the STOP button.**

### Memo

- During audio dubbing, if the tape comes to a part recorded in a mode in which audio dubbing cannot be performed (such as LP mode or 48 kHz audio mode), the VCR will enter the STOP mode. When this happens, loud noise from the DV output may come out. Hence, before audio-dubbing, check the recording mode of the tape.
- In the case that a microphone is connected to the MIC terminal, MIC sound from this terminal will be recorded. In the absence of MIC input, signals from the CH1/3, CH2/4 AUDIO IN terminal on the rear panel will be recorded.
- When audio dubbing cannot be performed, an alarm message will be displayed on the monitor. (E-35 Page 25)
- Audio dubbing pause cannot be carried out directly in the STOP mode. Do so in the STILL mode.  
During audio dubbing pause, sound from CH3/CH4 can be monitored, but sound output from the DV terminal is not possible.
- If audio dubbing is repeated on a short section of the tape, momentary noise may be produced when the section is played.
- During audio dubbing, noise may be produced on the playback video or EE sound, but the recording is not affected.
- The playback sound of CH1/2 cannot be recorded on CH3/4 (sound-on-sound).
- If unrecorded parts are found during backspace operation of audio dubbing, audio dubbing cannot be performed.
- When audio dubbing is performed on tapes recorded on other devices, it may not record correctly. Record with BR-DV6000 before performing audio dubbing.

# RECORDING

## - Backup recording function -

In combination with DV equipment, BR-DV6000 can perform continuous, long-hour recording. BR-DV6000 can be set as the backup unit connected to a DV camcorder (GY-DV300/DV500/DV550/DV5000, etc.). When the recording tape of the source unit nears its end, BR-DV6000 can start recording, enabling long-hour recording.  
Backup unit: BR-DV6000

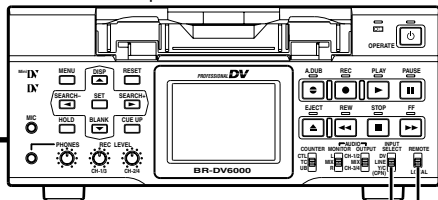
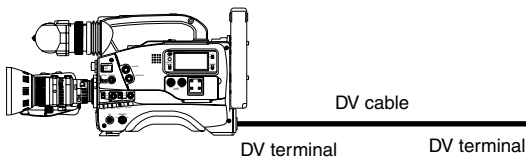

INPUT SELECT switch  
REMOTE/LOCAL switch

### Connection

Connect the DV terminal of the source unit to the DV terminal of BR-DV6000 with a DV cable.

### Setting up BR-DV6000

- Set the **INPUT SELECT** switch on the front panel to “DV”.
- Set the **REMOTE/LOCAL** switch on the front panel to “REMOTE”.
- Set **BACKUP REC TIME** in the **SYSTEM (1/2) Menu screen**.

Use the following settings according to the tape length of the source unit.

\* For DV or mini DV cassette tape:

25MIN	: 30-minute tape
55MIN	: 60-minute tape
75MIN	: 80-minute tape
115MIN	: 120-minute tape
175MIN	: 180-minute tape
265MIN	: 270-minute tape
OFF	: No backup recording

### Memo

With **REPLICATION** in the **SYSTEM (2/2) menu screen** set to “DV”, **BACKUP REC TIME** is fixed to “OFF”. For using the backup recording function, set **REPLICATION** to “OFF” or “SERIAL”.

- Set the **REMOTE SEL DV** in the **REMOTE (1/2) Menu screen** to **ON** or **LOC+REM**.
- Set **TC DUPLICATE** in the **TC/UB/CLOCK (1/2) Menu screen** to **OFF**.
  - It records the data of the built-in time code generator.
  - When **TC DUPLICATE** is set to **AUTO**, the time code of the DV camcorder will stop advancing. If the DV cable is disconnected, the time code of the backup recording will stop advancing.
- For using **GY-DV5000** as the source unit  
Set **DV REC TRIGGER** in the **OTHERS (1/2) Menu screen** of **GY-DV5000** to **OFF**.

### Operation

1. **Recording begins on the source unit.**
  - \* Ensure that recording starts from the beginning of the recording tape.
2. **BR-DV6000 begins recording when the tape of the source unit nears its end (about 5 minutes before the end of the tape).**
  - BR-DV6000 begins recording when the recording time of the source unit reaches the time set by **BACKUP REC TIME**.

### Memo

- In backup recording, BR-DV6000 records video/sound from the source unit. While this unit is performing backup recording, continue shooting from the source unit.
- The audio mode is the one selected in the source unit. (32 K/48 K)
- Set **BACKUP REC TIME** to “OFF” if the unit is not performing backup recording.

# RECORDING

## - Recording with serial remote terminals -

Recording can be turned ON/OFF with a serial remote controller or foot switch connected to the SERIAL REMOTE IN terminal located at the rear panel of BR-DV6000.

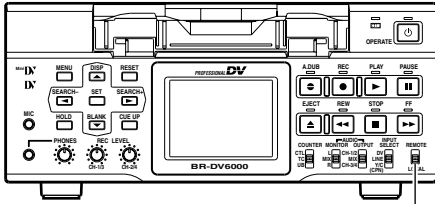

REMOTE/LOCAL switch

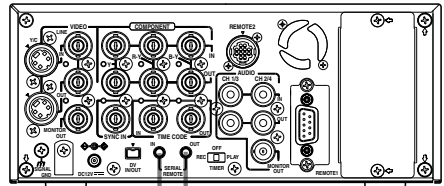

SERIAL IN SERIAL OUT



- Serial remote controller: RM-G30
- Foot switch

### REMOTE (1/2) Menu screen

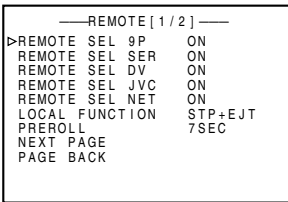

### Memo

- Besides recording, the serial remote controller can perform other functions.
- If the REMOTE SEL SER is set to ON, unit buttons that can be operated can be selected from LOCAL FUNCTION in the REMOTE (1/2) Menu screen.

### REMOTE (2/2) Menu screen

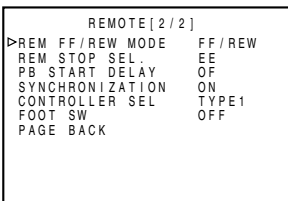

### Foot switch

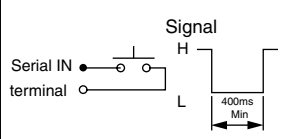

### Connection

The serial remote controller (RM-G30, sold separately) can be connected to the SERIAL REMOTE IN terminal located on the rear panel of BR-DV6000.

The input signals of the SERIAL REMOTE IN terminal can be through-output from the SERIAL REMOTE OUT terminal. (Only with OPERATE ON)

### Setting

■ To use the SERIAL IN terminal, set REMOTE SEL SER in the REMOTE (1/2) Menu screen to ON or LOC+REM. Then, set the REMOTE/LOCAL switch on the front panel accordingly.

#### • REMOTE SEL SER

**ON** : When the REMOTE/LOCAL switch is set to REMOTE, operations can be performed via the SERIAL REMOTE IN terminal.

**LOC+REM**: With the REMOTE/LOCAL switch is set either way, operations can be performed via the SERIAL REMOTE IN terminal. With this setting, the buttons and switches of the unit can be used too.

■ Set FOOT SW in the REMOTE (2/2) Menu screen according to how the serial remote terminal is used.

**OFF** : Set to OFF when the serial remote controller is used. The footswitch cannot be used.

**L EDGE** : Recording and recording pause is switched at the LOW edge of the footswitch signal.

**H EDGE** : Recording and recording pause is switched at the HIGH edge of the footswitch signal.

**L LEVEL** : Recording is performed at the LOW edge and paused at the HIGH edge of the footswitch signal.

### Operation

Before using the foot switch, set BR-DV6000 to the RECORDING or RECORDING PAUSE mode using the relevant buttons of the unit. (Only with L EDGE and H EDGE)

### Memo

- The foot switch can only be used to switch between RECORDING ON and OFF.
- The foot switch can be operated regardless of the setting of the REMOTE/LOCAL switch.

# RECORDING

## - External timer recording -

BR-DV6000 can start recording automatically when the power is supplied. Using a commercially available timer, recording can start at a pre-determined time.

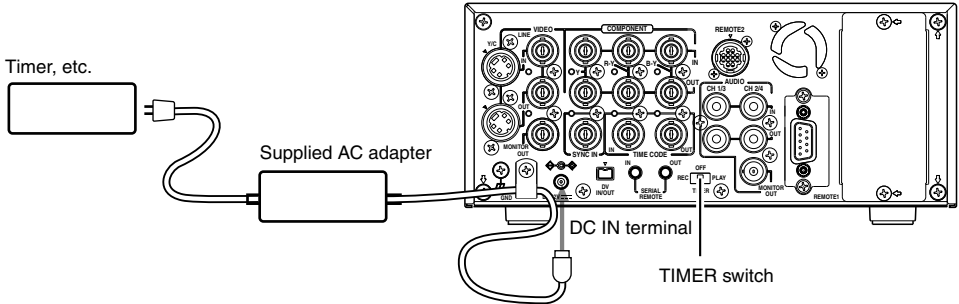

### Memo

Use an external timer exclusively to control the start of VCR operation. If the power is cut off by an external timer and the VCR operation is stopped while the tape is running, BR-DV6000 or the tape may be damaged.

### ■ Connect the supplied AC adapter.

To set the power supply to be activated by a timer, plug the power cord of the AC adapter to the power output terminal of the timer.

1. Set the REMOTE/LOCAL switch on the front panel to "LOCAL".
2. Select the video or sound to be recorded with the INPUT SELECT switch on the front panel.  
With VIDEO INPUT SEL in the VIDEO Menu screen, either the YC separate signal or the component signal can be selected.

### 3. Adjust the recording level of sound.

\* During DV input, the sound recording level cannot be adjusted.

### 4. Load a cassette tape for recording.

### 5. Set the TIMER switch on the rear panel to "REC".

OFF  
REC  PLAY  
TIMER

If the DISP button on the front panel is pressed to change the LCD display to the enlarged mode, the timer symbol  lights up in red.

### 6. Set the time, etc., of the external timer.

When the power is supplied to the unit, recording starts automatically.

### 7. To stop recording, press the STOP button.

### 8. To stop the external timer recording mode, set the TIMER switch to "OFF".

The timer symbol  of the LCD disappears.

DISP button

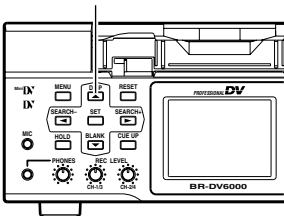

LCD display

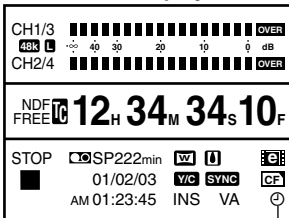

Timer symbol

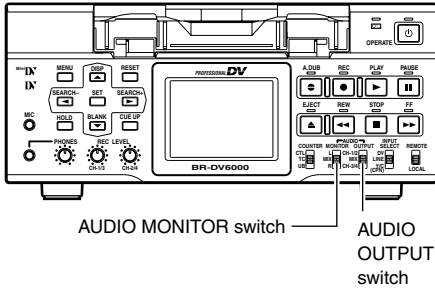

## ■ Setting the switches on the front panel

### ● AUDIO OUTPUT switch

To play back tapes recorded in the 32kHz mode, use this switch to select the audio channel for output signals from the AUDIO OUT terminal, AUDIO MONITOR OUT terminal or the PHONES terminal (CH 1/2, CH 3/4, MIX).

In the 48kHz mode, the sound of CH1 and CH2 is output regardless of the setting of this switch.

### ● AUDIO MONITOR switch

Use this switch to select the audio channel for output signals from the AUDIO MONITOR OUT (monaural) or PHONES terminal (L, MIX, R) (Page 13)

### SYSTEM (1/2) Menu screen

—SYSTEM[ 1 / 2 ]—	
▷ SYNC SELECT	AUTO
STL/F. ADV MODE	2ND
BACKUP REC TIME	OFF
LONG PAUSE TIME	5MIN
LONG PAUSE MODE	F. ADV
◀, ▶ KEY FUNC.	INDEX
REPEAT MODE	OFF
NEXT PAGE	
PAGE BACK	

### VIDEO Menu screen

—VIDEO—	
VIDEO INPUT SEL	Y/C
▷ SET UP (NTSC)	OFF
BLACK BURST	OFF
PAGE BACK	

### AUDIO Menu screen

---AUDIO---	
AUDIO MODE	48K
▷ A. OUT SEARCH	ON
AUDIO INPUT SEL	RCA
AUDIO OUT LEV	-20dB
V. FADE	ON
PAGE BACK	

## ■ SYSTEM Menu screen (Page 72)

### ● SYNC SELECT

This is for setting whether to use the internal signal or the input video signal as the synchronization signal during playback if there is no input of synchronization signals to the SYNC IN terminal.

**AUTO** : Input video signal

**EXTERNAL** : Internal signal

### ● STL/F.ADV MODE

This mode is for selecting still images or images of frame-advance playback. (Field image, 1st field image, 2nd field image and frame image)

### Memo

Output images from the DV terminal are fixed to the 1st field images.

### ● LONG PAUSE TIME

For setting the time (minute) when BR-DV6000 enters the tape protection mode if BR-DV6000 is in the STILL mode for a long time. (5, 3, 2, 1 minute or 30 seconds)

### ● LONG PAUSE MODE

For selecting the state of BR-DV6000 when it enters the tape protection mode after it stayed in the STILL mode for a prolonged period of time. (F.ADV or STBY-OFF)

### ● REPEAT MODE

This mode is for turning ON/OFF the REPEAT PLAYBACK function and selecting the type of REPEAT PLAYBACK. If REPEAT PLAYBACK is not performed, set it to OFF. (OFF, INDEX, V. END, TAPE END)

### ● PB/DV IN: SYSTEM (2/2) Menu

Set this item according to the signal format of the tape to be played.  
Set here to NTSC for a tape recorded in NTSC.

## ■ VIDEO Menu (Page 79)

### ● SET UP (for NTSC only)

For selecting whether to enable SET UP for analog video output signals (composite, Y/C separate or component).

## ■ AUDIO Menu (Page 78)

### ● A. OUT AT SEARCH

For selecting whether sound is output during variable speed playback.

### ● AUDIO OUT LEVEL

For selecting the reference level of the audio output level. (-20dB, -12dB)  
Set it to -12dB to playback tapes recorded at -12dB on a home-use DV machine.



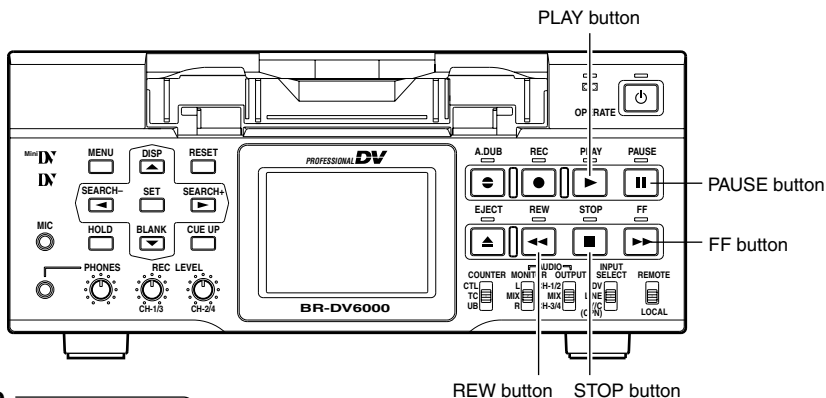

### Note

Tapes recorded in the LP mode cannot be played. The monitor displays an alarm message: "LP TAPE!"

### Memo

- Images cannot be produced properly if the signal format selected for PB/DV IN in the SYSTEM (2/2) Menu screen is different from the one of the tape to be played.
- When output of still image continues for a prolonged period, BR-DV6000 enters the tape protection mode. The time can be selected from LONG PAUSE TIME in the SYSTEM Menu screen.
- Only PAL/NTSC DVCAM tapes are detected automatically in the PLAYBACK mode.

### Playback of tapes recorded in the PAL format

BR-DV6000 does NOT automatically select NTSC/PAL playback. NTSC or PAL playback mode selection is performed in the menu.

- Set PB/DV IN in the SYSTEM (2/2) Menu screen to PAL for playing a tape recorded in PAL.
- Signal systems cannot be converted.

### 1. Load a recorded cassette tape.

→ The power for BR-DV6000 is turned on.

### 2. Start playback.

Press the PLAY button.

→ Playback starts. If the tape is recorded in the DVCAM format, the status display of the recording/playback speed mode (SP/LP) disappears from the monitor or LCD.

### 3. Pause the tape.

Press the PAUSE button.

→ A still image is output.

### Memo

The still image selected with STL/F.ADV MODE in the SYSTEM (1/2) Menu screen is output. (1st field image/ 2nd field image/ Frame image)

### 4. Resume playback.

Press the PLAY button.

### 5. Stop playback.

Press the STOP button.

### Fast forward/rewind

- When BR-DV6000 is in the STOP mode, press the FF button to fast-forward the tape.
- When BR-DV6000 is in the STOP mode, press the REW button to rewind the tape.

# PLAYBACK

## - Special playback functions -

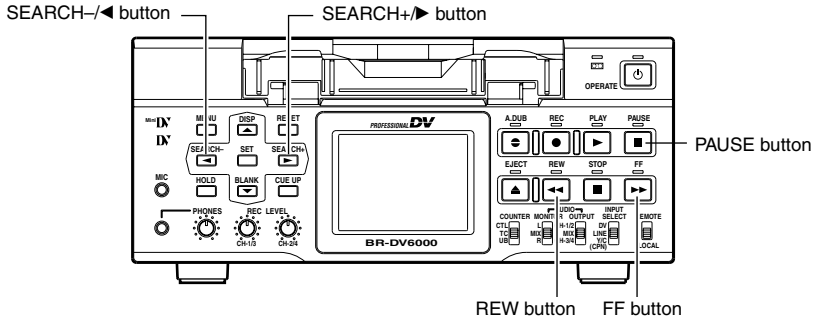

### Frame-advance playback

#### SYSTEM (1/2) Menu screen

```

---SYSTEM [1/2] ---
SYNC SELECT      AUTO
▶STL/F. ADV MODE 2ND
BACKUP REC TIME OFF
LONG PAUSE TIME 5MIN
LONG PAUSE MODE  F. ADV
*◀,▶* KEY FUNC.  VAR
REPEAT MODE      OFF
NEXT PAGE
PAGE BACK
    
```

#### Setting

##### ■ STL/F. ADV MODE in the SYSTEM (1/2) Menu screen

The unit of frame advance and still images can be selected.

**FIELD** : Field-by-field advance

**1st FIELD** : Frame-by-frame advance and stops at the 1st field.

**2nd FIELD** : Frame-by-frame advance and stops at the 2nd field.

**FRAME** : Frame-by-frame advance.

#### Operation

1. Set BR-DV6000 to the STILL mode.
2. Press the PAUSE button to perform frame advance.

### Search mode

#### Memo

- Whether to enable/disable audio out in the SEARCH mode can be selected with A. OUT AT SEARCH in the AUDIO Menu screen.
- Playback at  $\pm 0.1 \times$  speed is step-slow playback (continuous frame-advance playback / frame-reverse playback).
- During slow-playback or frame-advance, noise is generated to the output images from the DV terminal. For recording slow-playback images, use analog output signals of BR-DV6000.

#### Setting

##### ■ Set "◀,▶" KEY FUNC in the SYSTEM (1/2) Menu screen to VAR.

#### Operation

1. Set BR-DV6000 to the PLAYBACK or the STILL mode.
  2. Press the FF button to start fast-forward playback.  
Press the REW button to start reverse playback.
- Press the SEARCH+ button to increase the search speed. Every time you press this button, the speed increases more.
  - Press the SEARCH- button to decrease the search speed. Every time you press this button, the speed decreases more.

#### Search speed

SEARCH+ button → (Fast) (Slow) ← SEARCH- button  
 $\times -20 \dots \times -9 \dots \times -5 \dots \times -2 \dots \times -1 \dots \times -0.5 \dots \times -0.33 \dots \times -0.2 \dots$   
 $\times 0.1 \dots$  STILL  $\times 0.1 \dots \times 0.2 \dots \times 0.33 \dots \times 0.5 \dots \times 1$  (PLAY)  $\times 2 \dots$   
 $\times 5 \dots \times 9 \dots \times 20$

\* The maximum speed in the DVCAM mode is 15X.

## Increasing the playback speed by 7% or decreasing the speed by 10%

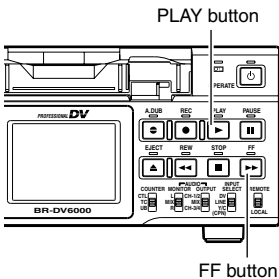

### Increasing the playback speed by 7%

1. Set BR-DV6000 to the **PLAYBACK**, **STILL** or **STOP** mode.
2. Press the **FF** button while holding down the **PLAY** button.  
While the buttons are held down, the playback speed is increased by 7%.
3. When the buttons are released, the operation changes as follows.
  - If the **PLAY** button is released first, playback continues at the increased speed of +7%. (**Latch mode**)  
To return to the normal playback speed, press the **PLAY** button.
  - If the **FF** button is released first, it returns to the normal playback speed.

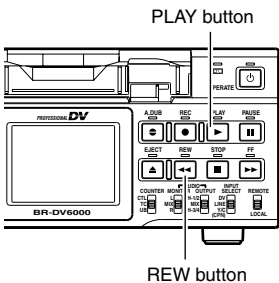

### Decreasing the playback speed by 10%

1. Set BR-DV6000 to the **PLAYBACK**, **STILL** or **STOP** mode.
2. Press the **REW** button while holding down the **PLAY** button.  
While the buttons are held down, the playback speed is decreased by 10%.
3. When the buttons are released, the operation changes as follows.
  - If the **PLAY** button is released first, the playback continues at the decreased speed of -10%. (**Latch mode**)  
To return to the normal playback speed, press the **PLAY** button.
  - If the **REW** button is released first, it returns to the normal playback speed.

## Index search

This function searches to the position where the index signal is recorded.

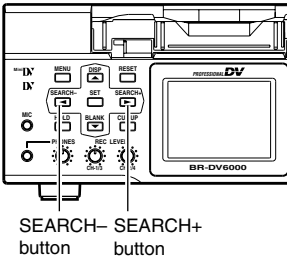

Monitor screen

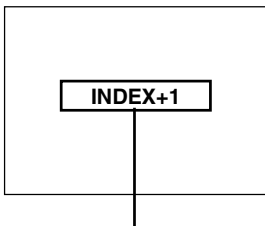

**Index search progressing:  
displayed on the screen**  
(The number denotes the  
corresponding index position.)

### Setting

Set “◀, ▶” KEY FUNC in the SYSTEM (1/2) Menu screen to IN-DEX.

### Operation

#### ■ To search an index point in the forward direction from the current tape position:

- Press the SEARCH + button.  
The index position to be searched can be specified by the number of times this button is pressed. (Max: 99)

#### ■ To search an index point in the reverse direction from the current tape position:

- Press the SEARCH – button.  
The index position to be searched can be specified by the number of times this button is pressed. (Max: 99)

#### ■ When the SEARCH + or SEARCH – button is pressed, the unit fast-forwards or rewinds to the specified indexed position and start playing.

### Memo

- If the interval between index signals is less than one minute, the function may not work well.
- The specifications for index signal recording varies with the device used.

## Blank search

This function searches unrecorded parts of the tape.

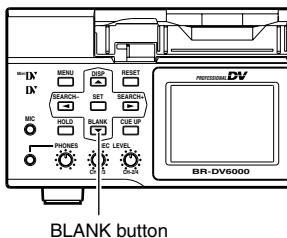

Monitor screen



#### ■ In the STOP mode, press the BLANK button.

- • If the current position is at a recorded part of the tape, BR-DV6000 fast-forwards until an unrecorded part is reached and stops there.
- If the current position is an unrecorded part of the tape, BR-DV6000 will first advance the tape in the forward direction for confirmation and thereafter rewind and go into the STILL mode at the last recorded position.
- During a blank search, “BLANK SEARCH” is displayed on the monitor.

# PLAYBACK

## - Repeat playback -

Three types of repeat playback are available for BR-DV6000.  
The repeat playback function can be set with REPEAT MODE in the SYSTEM (1/2) Menu screen.

### SYSTEM (1/2) menu screen

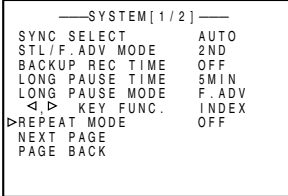

### Setting

#### ■ REPEAT MODE in the SYSTEM (1/2) Menu screen

- OFF** : No repeat playback.
- INDEX** : Repeat playback between positions where index signals are recorded.
- V. END** : Repeat playback from the beginning of the tape to the position where recording of video signals ends.
- TAPE END** : Repeat playback from the beginning to the end of the tape.

### INDEX repeat playback

- If no index signal is detected during playback, the tape will run until the end. If no index signal is detected during rewind, the tape will rewind until the beginning.
- If the interval between index signals is less than one minute, the function may not work well.

### Memo

If the head is dirty, repeat playback may not work well.

### Operation

1. Press the REW button to rewind the tape to the beginning.
2. Press the PLAY button to start playback.  
→ When it reaches the position set at REPEAT MODE, the tape starts rewinding and plays back again.

- To abort the repeat playback function, press the STOP button.

### Repeat operation

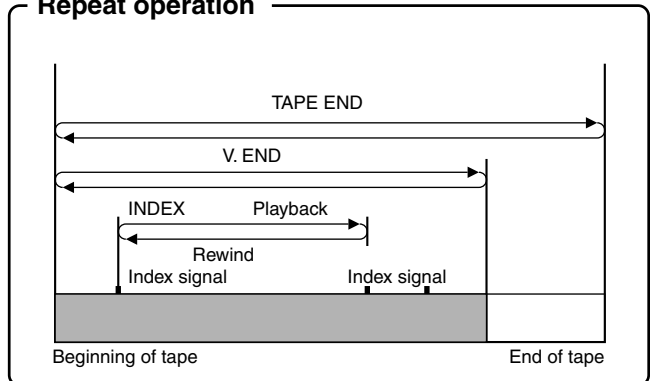

Using the time codes recorded on the tape, up to 5 points on the tape can be registered as cue-up points at the Multi Cue-up screen. The registered tape positions (cue-up points) can be searched.

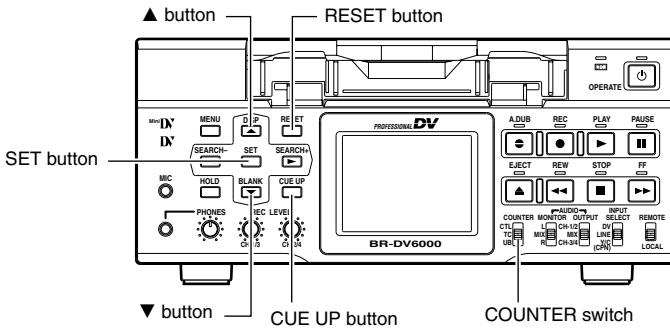

### Registering cue-up points

1. Set the COUNTER switch to TC.
2. Load a tape with time codes recorded.
3. Press the CUE UP button.
  - The CUE UP screen appears on the monitor or the LCD.
4. Perform playback or search. At the position to be registered, set it to the STILL or STOP mode.
5. Press the ▲ or ▼ button to bring the cursor to the cue-up point. Press the SET button.
  - Register the time code data of the current position as a cue-up point.
  - If no tape is loaded, "00" is registered.
  - Cue-up points can be registered while the tape is being played back.
6. To register more cue-up points, repeat steps 4 and 5. Up to 5 cue-up points can be registered.

#### Memo

For details on time code setting and recording: (Page 59)

Cursor

Cue-up point

```

---MULTI CUE UP---
CUE1  00:01:35:11
CUE2  03:42:59:21
CUE3  --:--:--:--
CUE4  11:21:48:07
CUE5  --:--:--:--
EXIT
*SET*  :ENTRY CUE DATA
*RESET*:CLEAR CUE DATA
*CUE UP*:EXECUTE CUE UP
    
```

Multi Cue-up screen

### Clearing registered cue-up points

Press the ▲ or ▼ button to bring the cursor to the cue-up point to be cleared. Press the RESET button.

→ After a cue-up point is cleared, "--" is displayed.

SET  
button

▲ button

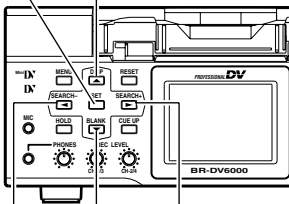

◀ button ▼ button ▶ button

### Memo

If the COUNTER switch is set to CTL or UB while the Multi Cue-up screen is being displayed, the display returns to the normal screen.

## Changing cue-up points

- ① Press the ▲ or ▼ button to bring the cursor to the cue-up point to be changed. Press the ▶ button.  
→ The hour digits of the registered time code display blink.  
Press the ▶ button to select the digit to be changed.
- ② Press the ▲ or ▼ button again to change the time code.  
Press the ▲ button to increase the time code data.  
Press the ▼ button to decrease the time code data.
- ③ Press the SET button to register the changed time code.  
If no time code is to be registered, do not press the SET button. Instead, press the ◀ button to make the blinking time code display disappear.

## Exiting the Multi Cue-up screen

Press the ▲ or ▼ button to bring the cursor to EXIT. Press the SET button.

→ The display of the monitor or the LCD returns to the normal screen.

## Searching cue-up points

▲ button

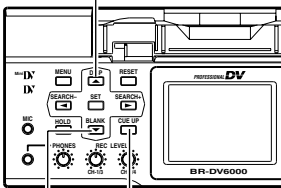

▼ button CUE UP button

1. Set the COUNTER switch to TC.
2. Press the CUE UP button when the normal screen is displayed.  
→ The Multi Cue-up screen appears on the monitor or the LCD.
3. Press the ▲ or ▼ button to bring the cursor to the cue-up point to be searched.
4. Press the CUE UP button.  
→ The cue-up operation for the selected point is performed.

Cue-up point

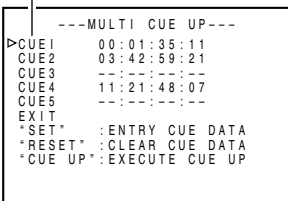

Multi Cue-up screen

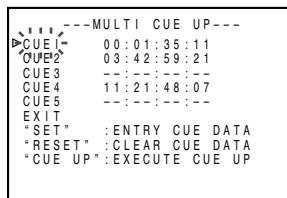

During Cue-up operation

While searching is being performed, the cue-up point to be searched flashes on the monitor or the LCD.

### Memo

- For cue-up operation, use tapes with continuous time codes recorded.
- If the COUNTER switch is set to CTL or UB while the Multi Cue-up screen is being displayed, the COUNTER mode does not change.

# PLAYBACK

## - External timer playback -

The unit can start playing automatically when the power is supplied. Using a commercially available timer, playback can start at a pre-determined time.

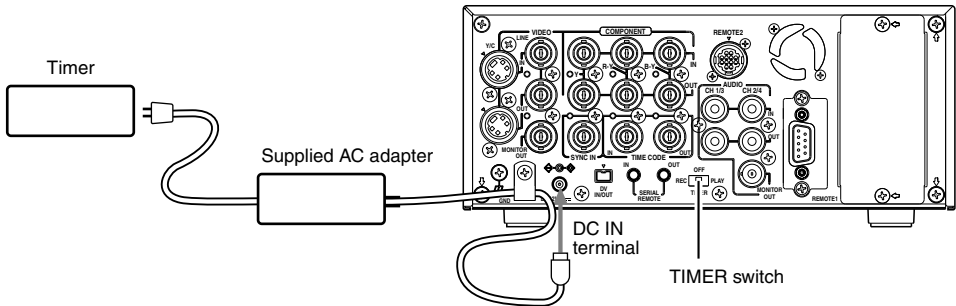

### Memo

Use an external timer exclusively to control the VCR operation. If the power is cut off by an external timer and the VCR operation stopped while the tape is running, BR-DV6000 or the tape may be damaged.

### ■ Connect the supplied AC adapter.

To set the power supply power to be activated by a timer, plug the power cord of the AC adapter to the power output terminal of the timer.

1. Load the tape for playback.
2. With REPEAT MODE in the SYSTEM (1/2) Menu screen, whether to enable/disable repeat playback, and the type of repeat playback, can be selected.
3. Set the TIMER switch on the rear panel to "PLAY".

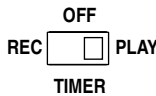

If the DISP button on the front panel is pressed to change the LCD display to the enlarged mode, the timer symbol lights up in green.

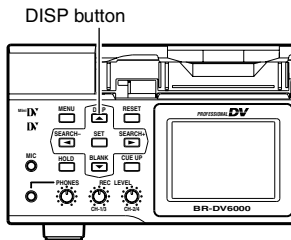

### LCD Display

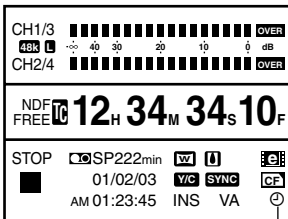

Timer symbol

### 4. Set up the time, etc., of the external timer.

When the power is supplied to the unit, playback starts automatically. If the repeat playback mode is selected, repeat playback is executed.

### 5. To stop playback, press the STOP button.

### 6. To stop the external timer playback mode, set the TIMER switch to "OFF".

The timer symbol of the LCD disappears.



# PLAYBACK

## - Dubbing with another machine using the SERIAL REMOTE OUT/DV terminals -

When the REPLICATION function is turned ON and BR-DV6000 is set to the PLAYBACK mode, the REC command will output from the SERIAL REMOTE OUT terminal or the DV terminal. With this function, the video and sound being played back on BR-DV6000 can be dubbed by another machine by simply pressing the PLAY button.

■ For recording analog video and audio signal, use the SERIAL REMOTE OUT terminal.

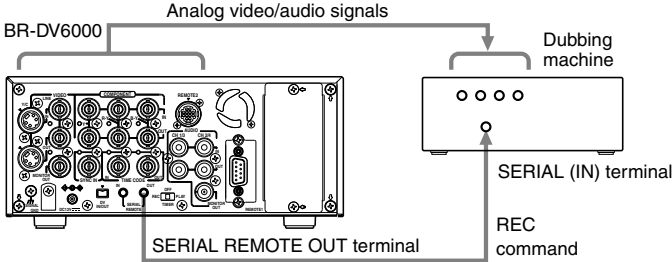

**Memo**  
For information on connection with the SERIAL REMOTE OUT terminal: (Page 34)

■ For recording digital video and audio signals, use the DV terminal.

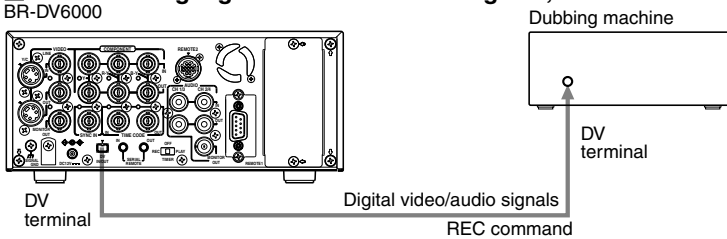

```

---SYSTEM [ 2 / 2 ] ---
DC IN MODE          OPE OFF
INDEX WRITE         ON
▷REPLICATION         SERIAL
REPLICATE DELAY     OFF
PB/DV IN           NTSC
FACTORY SETTING     CANCEL
DRUM HOUR METER    000000
PAGE BACK
    
```

SYSTEM (2/2) Menu screen

### Setting

#### ■ BR-DV6000

- For using the DV terminal, set **BACKUP REC TIME** in the **SYSTEM (1/2) menu screen** to "OFF".
- Set the items in the **SYSTEM (2/2) Menu screen**.
  - Set REPLICATION to SERIAL or DV depending on the terminal.
  - To delay the output timing for the REC command in the PLAYBACK mode, set REPLICATE DELAY (OFF, 1 - 5 seconds). If the DV terminal is to be used, set REPLICATE DELAY to a larger value.

#### ■ Dubbing machine

- When the SERIAL terminal is to be used, select the mode that can receive commands of the SERIAL (IN) terminal.
- When the DV terminal is to be used, select the DV input mode.

### Operation

1. Load a tape for playback into BR-DV6000 and a tape for recording into the dubbing machine.
2. Press the PLAY button to set BR-DV6000 into the PLAYBACK mode.
  - The unit outputs the REC command from the SERIAL REMOTE OUT terminal or the DV terminal and the dubbing machine starts recording.
3. To stop recording, press the STOP button of the dubbing machine.
4. To exit from the REPLICATION mode, set REPLICATION to OFF.

**Memo**  
With the DV terminal in use, this function and the backup recording function cannot be operated at the same time.

# TIME CODE

## - Displaying the time code -

BR-DV6000 can record and play back SMPTE-compliant time code and user's bit. With the time code function, accurate positions of the tape contents can be specified to enhance editing precision and operation efficiency. During recording or playback, the time code and user's bit are displayed on the monitor or the LCD.

- TCG : Time code generator data
- TCR : Time code reader data
- DTCG : Input time code data from the DV IN/OUT terminal
- ETCG : Input time code data from the TIME CODE IN terminal
- UBG : User's bit generator data
- UBR : User's bit reader data
- DUBG : User's bit input data from the DV IN/OUT terminal
- EUBG : User's bit input data from the TIME CODE IN terminal

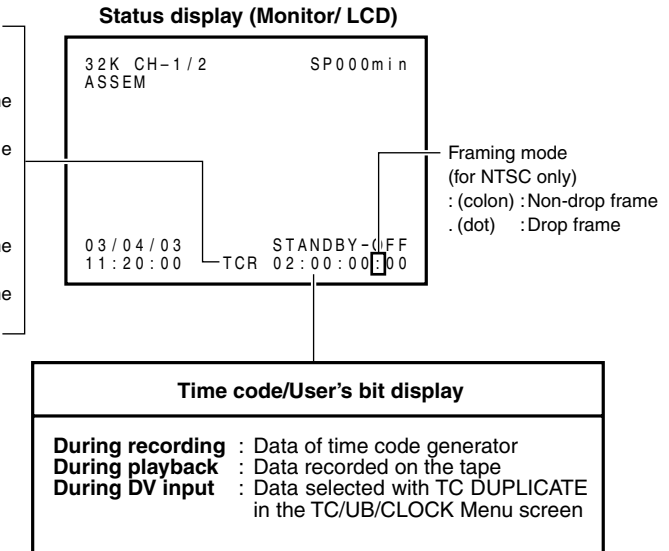

### DISPLAY (1/2) Menu screen

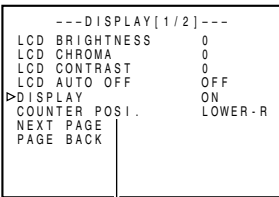

The display position can be selected.

### DISPLAY (2/2) Menu screen

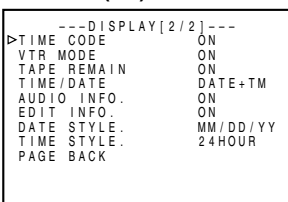

### ■ To display the time code/ user's bit, perform the following settings.

- Set DISPLAY in the DISPLAY (1/2) Menu screen to ON or AUTO.  
→ The status is displayed on the monitor or the LCD.
- Set TIME CODE in the DISPLAY (2/2) Menu screen to ON.  
→ The time code, user's bit or CTL counter is displayed at the counter display section of the status display.
- Select the counter display mode with the [COUNTER] switch on the front panel.

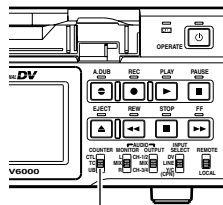

COUNTER switch

- To display the time code, select TC.
- To display the user's bit, select UB.

### Checking the data of time code generator

When it is in the STOP mode, press the REC button and the data of the time code generator will be displayed while the button is held down.

# TIME CODE

## - Presetting the time code -

Variable values can be set for the time code and the user's bit for efficient material management and editing.

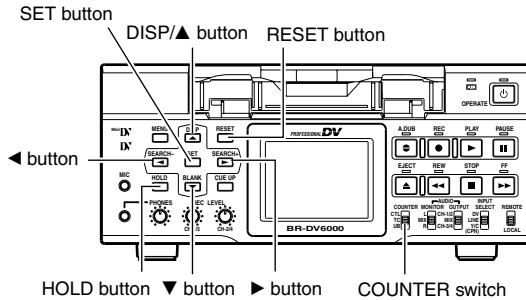

### TC/UB/CLOCK(1/2) Menu screen

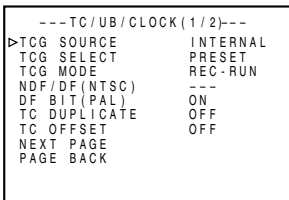

### Setting ...TC/UB/CLOCK(1/2) Menu screen

■ Set TCG SOURCE to "INTERNAL".

■ Set TCG SELECT to "PRESET".

■ TCG MODE:

REC-RUN : The time code runs only during recording.

FREE-RUN : The time code runs from the point when the preset is completed.

\* In the case of the user's bit, setting is not required.

■ NDF/DF (NTSC):

NON DROP : Non-drop frame mode. Use this setting if the number of frame is more important.

DROP : Drop frame mode. Use this setting if the recording time is more important.

### LCD display

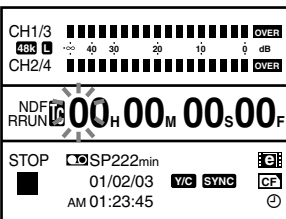

### Operation ... Perform setting while checking the LCD display.

This section describes the setting of the time code. The setting of the user's bit is the same. Values that can be used to configure the user's bit are hexadecimal numeral from 0 – F.

**1. Set the counter switch to TC.**

(For user's bit, set the switch to UB.)

**2. Press the DISP button to change the LCD to its enlarged display mode.**

**3. In the STOP mode, press the HOLD button.**

→ The hour digit of the counter starts blinking.

**4. Press the ▲ or ▼ button to change the value.**

**5. Press the ▶ or ◀ button to move blinking to the next digit.**

**6. Press the ▲ or ▼ button to change the value of the blinking digit.**

**7. Repeat steps 5 and 6 to perform the necessary settings.**

**8. Press the SET button to confirm the setting value and blinking of the counter stops.**

### Memo

- To stop the setting, press the HOLD button to return to the normal screen.
- To preset all digits to 0, press the RESET button when any of the digits is blinking.
- When the hour digit is blinking, the frame digit starts blinking when the ◀ button is pressed.
- If a user's bit is input with its all digits set as "F", BR-DV6000 converts FFFFFFFF to FFFFFFFF before recording.

Time codes can be recorded with the following ways.

- Record it from preset data.
- Record it following the one last recorded on the tape.
- Record the time code, which is input to the DV IN/OUT terminal.
- Record the time code from an external time code generator.

## Recording from preset data

Record preset time code data to the internal time code generator in the TIME CODE Preset screen.

### TC/UB/CLOCK(1/2) Menu screen

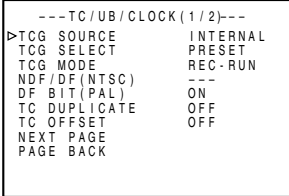

### Setting

- Set the TC/UB/CLOCK(1/2) Menu as follows.

**TCG SOURCE** : INTERNAL  
**TCG SELECT** : PRESET  
**TCG MODE** : REC RUN or FREE RUN  
**NDF/DF (NTSC)** : NON DROP or DROP frame mode.

### Operation

#### 1. Check the preset time code.

- ① Set the COUNTER switch to TC or UB.
- ② In the STOP mode, hold down the REC button.  
→ The preset time code or the user's bit is displayed on the monitor or the LCD. The counter mode is displayed as TCG or UBG.
- ③ When the REC button is released, it returns to the original display.

#### 2. Record.

- Press the PLAY button while holding down the REC button.  
→ The time code and user's bit are recorded.  
To stop recording, press the STOP button.

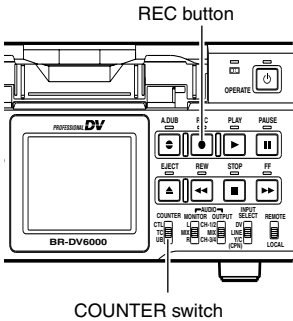

### Preset time code

- Stopping the power supply to the DV IN terminal of BR-DV6000 cancels the preset value of the time code generator.
- With FREE RUN, if the mode is changed from OPERATE ON to OPERATE OFF and back to OPERATE ON before BR-DV6000 is restarted, the advance of the time generator may deviate. Do not change the mode to OPERATE OFF to keep the time generator data agreed with those of other machines.

## Recording time code following the one last recorded on the tape

BR-DV6000 is equipped with a time code reader. When it enters the RECORD mode from the RECORDING PAUSE mode, it reads the time code data already recorded on the tape and continues recording time code from that value. (Regeneration)

### TC/UB/CLOCK(1/2) Menu screen

```
---TC/UB/CLOCK(1/2)---
▷TCG SOURCE      INTERNAL
TCG SELECT       REGEN
TCG MODE         REC-RUN
NDF/DF(NTSC)    ---
DF BIT(PAL)     ON
TC DUPLICATE     OFF
TC OFFSET       OFF
NEXT PAGE
PAGE BACK
```

### Setting

- Set the TC/UB/CLOCK(1/2) Menu as follows.

**TCG SOURCE** : INTERNAL

**TCG SELECT** : REGEN

**TCG MODE** : No setting required. It will be in the same running mode as the tape.

**NDF/DF (NTSC)** : No setting is required. It will be in the same frame mode as the tape.

### Operation

1. Insert a tape with time codes recorded.
2. Set BR-DV6000 to the RECORDING PAUSE mode at the position where time codes are to be recorded again.
3. Press the PLAY button to go to the RECORDING mode.
  - Time codes will be recorded on the tape, starting from where it stopped at last recording.The counter mode display shows either TCR or UBR.

## Recording time code, input to the DV IN/OUT terminal

### TC/UB/CLOCK(1/2) Menu screen

```
---TC/UB/CLOCK(1/2)---
TCG SOURCE      INTERNAL
TCG SELECT       PRESET
TCG MODE         REC-RUN
NDF/DF(NTSC)    ---
DF BIT(PAL)     ON
▷TC DUPLICATE    AUTO
TC OFFSET       OFF
NEXT PAGE
PAGE BACK
```

### Setting

- Set the INPUT SELECT switch on the front panel to DV.
- Set TC DUPLICATE in the TC/UB/CLOCK(1/2) Menu screen to AUTO.

\* To record time codes in the NON DROP frame mode from BR-DV6000 or GY-DV500, set TC DUPLICATE to NON DROP.

### Memo

Time codes input to the TIME CODE IN terminal are ignored.

Do not connect any device to the TIME CODE OUT terminal.

### Operation

1. Check the time code of the DV input terminal.

Press the REC button when BR-DV6000 is in the STOP mode to display the time code on the monitor or the LCD. It will be displayed while the button is held down.

The counter mode display shows DTCC or DUBG.
2. Select the RECORDING mode.
  - Record time codes from the DV input terminal.

### Memo

- For date/time also, data from the DV IN terminal are recorded.
- When this terminal is connected to a D9 VCR, data/time data are not recorded.

### Record time codes from an external time code generator

Synchronize the internal time code generator with the SMPTE-compliant LTC time code, which is input from the TC IN terminal. After synchronization (slave lock), the internal time code generator continues to run even if external time code signals are not input.

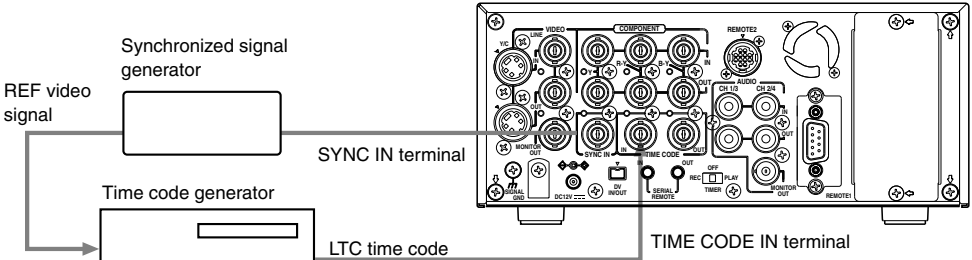

### Connection

- Input reference video signals to the external time code generator and the SYNC IN terminal of BR-DV6000.
- Connect the TIME CODE IN terminal of BR-DV6000 with the LTC time code output terminal of the external time code generator.

### Setting

#### ■ Front switches

- Set the INPUT SELECT switch to any setting except DV.
- Set the COUNTER switch to "TC".
- Press the DISP button and set the LCD to the enlarged display mode.

#### ■ TC/UB/CLOCK(1/2) Menu screen

Set TCG SOURCE to "EXTERNAL".

#### TC/UB/CLOCK(1/2) Menu screen

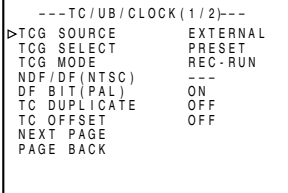

### Memo

- If the phase of the external time code generator and the phase of the video are not synchronized, the "EXT" display blinks.
- If a user's bit is input to the TIME CODE IN terminal with its all digits set as "F", BR-DV6000 converts FFFFFFFF to FFFFFFFF before recording.

### Operation

#### 1. Perform setting for the external time code generator.

#### 2. Set BR-DV6000 to the RECORDING mode.

→ The EXT display of the LCD lights up and the time code and user's bit of the external time code generator are recorded on the tape.

During recording, if the internal time code generator is slave-locked once, the time code continues to run even if the input time code stops.

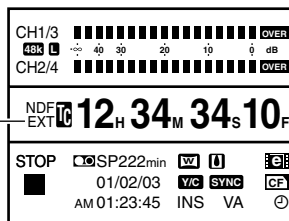

EXT display

# TIME CODE

## - Playing back the time code -

BR-DV6000 is also equipped with a time code reader. During playback, the time code or user's bit data recorded on the tape is displayed on the monitor or the LCD.

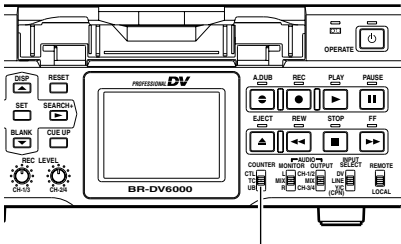

COUNTER switch

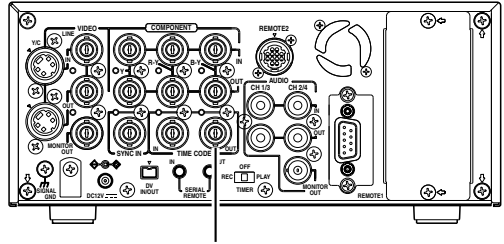

TIME CODE OUT terminal

### Monitor / LCD (Status display)

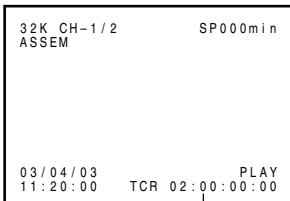

Time code or user's bit

### 1. Select the time code data to display.

Set the COUNTER switch to "TC" or "UB".

### 2. Press the PLAY button to go to the PLAYBACK mode.

→ It displays the time code and the user's bit on the monitor or the LCD. The counter display mode becomes TCR or UBR.

- The LTC time code is output from the TIME CODE OUT terminal on the rear panel.

\* The VITC time code is not output.

If the COUNTER switch is set to CTL, the time code is not output.

### Caution on time code playback

- During playback, if a portion of tape without recorded time code runs through, the time code stops running. Playback continues.
- If tapes without recorded user's bit, e.g. those recorded with a home-use DV VCR, are played back on BR-DV6000, "—" is displayed.

## **EDIT – Editing with an RS-422A/JVC bus edit remote controller –**

BR-DV6000 is designed to be capable to make tape-to-tape editing by RM-G800/G805 JVC bus remote controller or RM-G820 as well as other equivalent RS-422A remote controller. Of course, it can be applied to feeder player.

- +/- 0 frame editing accuracy with time code, capstan bump (for both recorder and player) and external sync by RS-422A editing controller.
- Ready for A/B roll editing.
- Digital editing via DV interface.

### **■ Chart for editing mode when BR-DV6000 is used as editing recorder**

#### **1) Editing over recorded tape with 48 kHz audio in analog interface**

Edit mode		Analog editing
Mode select	OSD	48 kHz mode
ASSEM	ASSEM	Yes
VIDEO	INS V	Yes
VIDEO AUD-1 AUD-2	INS VA	Yes
AUD-1 AUD-2	INS A	Yes
VIDEO AUD-1	INS VA1	No *
VIDEO AUD-2	INS VA2	No *
AUD-1	INS A1	No *
AUD-2	INS A2	No *
TC	INS TC	Yes

\* : In this mode, even when you start auto edit, editing will automatically stop and warning message will appear. But, preview edit will be performed without any warning message.

#### **2) Editing over recorded tape with 32 kHz audio in analog interface**

Edit mode		Analog editing
Mode select	OSD	32 kHz mode
ASSEM	ASSEM	Yes* <sup>2</sup>
VIDEO	INS V	Yes
VIDEO AUD-1 AUD-2	INS VA	Yes* <sup>2</sup>
AUD-1 AUD-2	INS A	Yes* <sup>2</sup>
VIDEO AUD-1	INS VA12	Yes
VIDEO AUD-2	INS VA34	Yes
AUD-1	INS A12	Yes
AUD-2	INS A34	Yes
TC	INS TC	Yes

\*<sup>2</sup> : In case of CH1/CH2/CH3/CH4 simultaneous insert or assemble edit mode of 32 kHz audio, input signal to audio input connector CH1/CH3 is recorded onto CH1 and CH3 tracks simultaneously and input signal to audio input connector CH2/CH4 is recorded onto CH2 and CH4 tracks simultaneously.



### 3) Editing over recorded tape with 48 kHz or 44.1 kHz audio in DV interface

Edit mode		DV editing
Mode select	OSD	48 kHz/44.1 kHz mode
ASSEM	ASSEM	Yes
VIDEO	INS V	Yes
VIDEO AUD-1 AUD-2	INS VA	Yes
AUD-1 AUD-2	INS A	Yes
VIDEO AUD-1	INS VA1	No*
VIDEO AUD-2	INS VA2	No*
AUD-1	INS A1	No*
AUD-2	INS A2	No*
TC	INS TC	No

\* : In this mode, even when you start auto edit, editing will automatically stop and warning message will appear. But, preview edit will be performed without any warning message.

### 4) Editing over recorded tape with 32 kHz audio in DV interface

Edit mode		DV editing
Mode select	OSD	32 kHz mode
ASSEM	ASSEM	Yes
VIDEO	INS V	Yes
VIDEO AUD-1 AUD-2	INS VA	Yes
AUD-1 AUD-2	INS A	Yes
VIDEO AUD-1	INS VA12	No*
VIDEO AUD-2	INS VA34	No*
AUD-1	INS A12	No*
AUD-2	INS A34	No*
TC	INS TC	No

\* : In this mode, even when you start auto edit, editing will automatically stop and warning message will appear. But, preview edit will be performed without any warning message.

#### Note for audio insert editing (48 kHz/32 kHz mode)

- If the audio mode setting by menu on BR-DV6000 (audio mode of input signal in DV interface) is different from that of audio mode of the recorded tape, insert editing is impossible. (If editing is performed, it will automatically stop.)
- If the audio mode is changed during performing audio insert editing,
  - In case of DV interface editing, editing will be continued in accordance with the changed audio mode.
  - In case of analog interface editing, if the audio mode of the recorded tape is changed from 32 kHz mode to other mode, editing will automatically stop during CH1/2 or CH3/4 audio insert editing.
  - In case of analog interface editing, editing will be continued in accordance with the audio mode setting by menu on BR-DV6000 during CH1/2/3/4 simultaneous audio insert editing or assemble editing even if the audio mode of the recorded tape is changed.

#### ■ Following editing mode is not available

- Variable motion editing
- Slow motion editing
- Audio or Video split editing
- Frame by frame editing (if editing of duration of less than 10 frames, it will automatically perform 10 frames editing)
- CTL editing (Editing may be possible in CTL mode, but since counter data cannot be coincided with tape position, editing accuracy will become worse.)

## **EDIT - Editing with an RS-422A/JVC bus edit remote controller - (continued)**

### **Editing procedure with BR-DV6000**

#### **Connection**

For details on connection, refer to pages 32 and 33.

#### **Setting**

##### **■ Set the REMOTE/LOCAL switch on the front panel to REMOTE.**

##### **■ SYSTEM (1/2) Menu screen**

**SYNC SELECT** : If there is no input of synchronization signals to the SYNC IN terminal, set this item of the recorder to AUTO. During playback, it synchronizes with the input video signal.

##### **■ REMOTE (1/2) Menu screen**

###### **• Set REMOTE SEL 9-PIN to ON (for RS-422A).**

**Memo** : To use the REMOTE 2 (12-PIN) terminal simultaneously, set REMOTE SEL JVC to "OFF".

###### **• Set REMOTE SEL JVC to ON (for JVC-BUS).**

**Memo** : To use the REMOTE 1 (9-PIN) terminal simultaneously, set REMOTE SEL 9-PIN to "OFF".

###### **• PREROLL:**

Use this item to set the preroll time (second). It is recommended that at least 7 seconds be set.

**Memo** : The setting by the editing remote controller precedes if applicable.

##### **■ REMOTE (2/2) Menu screen**

###### **• REM STOP SEL (only for RS-422A)**

Select the mode for BR-DV6000 to be in when it receives standby-on signals.

**EE** : EE mode (STOP mode)

**PB** : Playback mode (STILL mode)

###### **• PB START DELAY**

Set the editing timing. If the start points of edit are not concurrent, adjust the playback startup timing.

**0F** : No correction

**1F-15F**: Delays the timing for the duration of the set frames. If BR-DV6000 is connected to an editing remote controller with no bump function, use this setting to adjust the edit precision.

**Memo** : No bump function is available for RM-G800/G805.

###### **• SYNCHRONIZATION (only for RS-422A)**

Whether to use the bump function to enhance edit precision can be selected.

**OFF** : Bump off

**ON** : Bump on. It may slow down the edit operation.

###### **• CONTROLLER SEL (only for RS-422A)**

Set this item according to the type of controller to be connected. (Refer to Page 77)

Set it to TYPE 1 when RM-G820 is used.

##### **■ TC OFFSET in the TC/UB/CLOCK (1/2) Menu screen (only for RS-422A)**

To edit DV signals, set the timing for the time code to be output to the editing controller from BR-DV6000.

Usually, this item is set to OFF.

##### **■ To edit with DV connection**

• Set the player input selection to other than DV.

• If the bump function is to be used, operate the function from the player. In the case of an editing remote controller for which the function is operated from the recorder, set the preroll time to at least 10 seconds.

• For both player and recorder, set REM STOP SEL to PB.

---

## ■ Setting the TIME CODE mode (used as editing recorder)

It is necessary to set time code parameters (when it is used as a recorder) and time code recording mode in accordance with system.

### • INTERNAL-REGEN (Regeneration mode)

Time code will be continued to time code information of the prerecorded tape.

This is the factory's default setting. This mode is especially intended for the following situations:

- When using the JVC bus remote controller.
- When not interfacing with external sync.

### • INTERNAL-PRESET-FREERUN (Free run mode)

Please choose this mode when you want to preset time code from the RS-422A remote controller.

Please note that time code will be discontinued when an external sync signal is not input to both the editing recorder, player and the editing controller.

### • INTERNAL-PRESET-RECRUN (REC RUN mode)

Select this mode if the RM-G800/G805 TC insert function is to be used.

## ■ Setting of RM-G820

PREROLL	: It is recommended that at least 7 seconds be set.
EDIT TIMING	: -5 frames
BUMP	: ON
BUMP SELECT	: PLAYER
Counter	: LTC

## Making prerecorded base tape (used as editing recorder)

**Both in the case of analog interface editing** : To make a prerecorded tape with the appropriate audio mode to your liking.

**And in the case of DV interface editing** : To make a prerecorded tape with the audio mode corresponding with the source tape.

It is necessary to record continuous time code information on a prerecorded tape.

Please refer to "Presetting the time code" section. (☞ Page 59)

---

### Note

When editing, we recommend "blank stripe" tapes on the same VCR that will be used for editing. Visual or audio imperfections may occur when editing tapes recorded in another VCR, with poor tape path linearity, or when the original tape was recorded or stored in high temperature.

## Confirmation by preview editing

Before performing editing, it is possible to check the edit-in and -out points in preview editing.

It does not work with the JVC bus interface editing controller.

If the editing controller has a learn function, it is recommended that this function is used.

To activate the capstan bump function, it is necessary to set sufficient pre-roll time. It is recommended that a minimum of 7 seconds is set.

---

### Note

- During preview or editing, switching timing of picture and audio in edit points appear shifted a few frames from actual recorded points, but the final images will be recorded at the correct location on the tape.
- When the JVC bus interface editing controller is used, the monitor output picture of the recorder always shows the player. It is not possible to check PB/EE switching at edit points.

## Perform editing

After setting edit points, starts editing by using perform button on the editing controller.

---

### Note

- Occasionally, pictures or audio noise may appear during the playback process in editing, but the recording will be fine.
- Occasionally, noise may occur at the edit points when editing repeatedly at the same frame many times.

Tape contents of BR-DV6000 are captured by a non-linear editing system and the non-linear edited contents are recorded on BR-DV6000.

### Connection

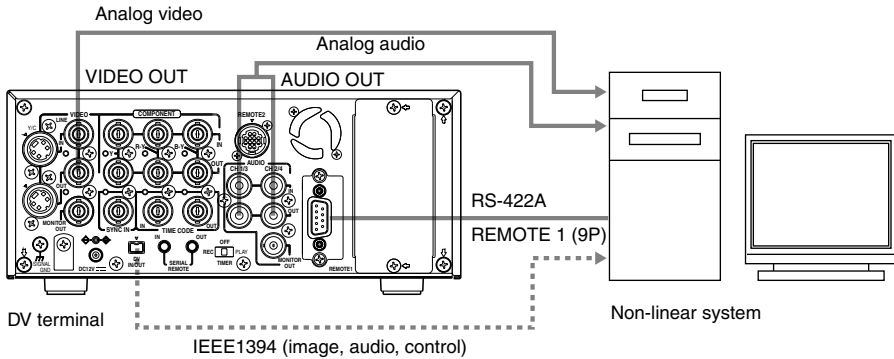

### Control with RS-422A (Analog signals)

### Control with the DV terminal (Digital signals)

### Setting

- **Set the REMOTE/LOCAL switch on the front panel to REMOTE.**
- **REMOTE (1/2) Menu screen**
  - Set REMOTE SEL 9-PIN to "ON".
- **REMOTE (2/2) Menu screen**
  - **REMOTE FF/REW MODE:**  
Use this item to select the operation to be performed if the FF or REW command is received during playback. (FF/REW or Search)  
If the search operation is not performed properly, set it to "SEARCH".
  - **CONTROLLER TYPE (in the REMOTE 2/2 Menu screen):**  
Set this item to "TYPE1".

### Setting

- **REMOTE (1/2) Menu screen**
  - **Set REMOTE SEL DV to ON or LOC+REM.**  
Set this item to ON if it is to become enabled only when the REMOTE/LOCAL switch on the front panel is set to REMOTE.  
Set this item to LOC+REM if it is to become enabled regardless of the position of the REMOTE/LOCAL switch.

### Memo

If the time code of BR-DV6000 is not displayed correctly when the non-linear side moves one frame forward or backward, set the STILL mode to "FRAME."

# MENU SCREENS

## - Structure of the Menu screens -

The Menu screens are displayed on the monitor or the LCD. They are structured with multiple layers.

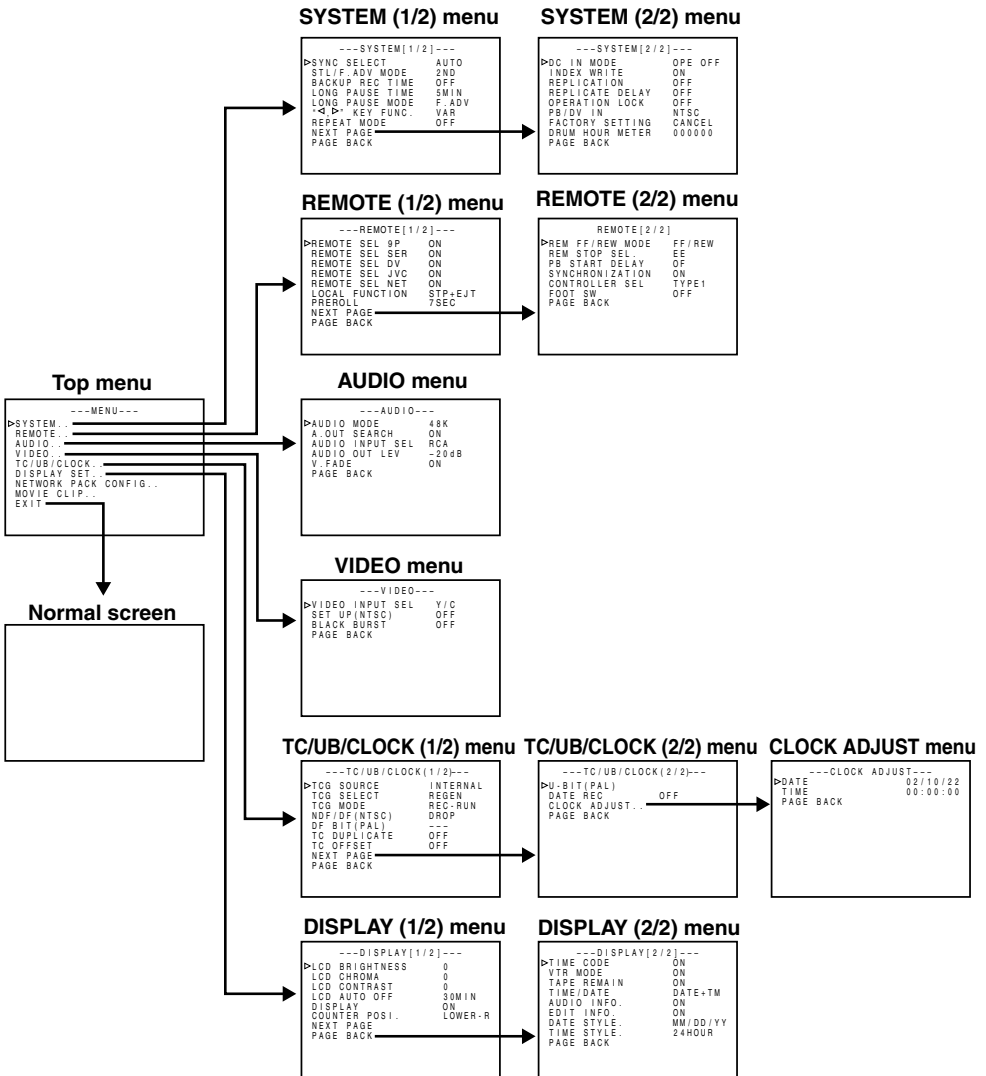

# MENU SCREENS

## - Setting the menus -

The functions of BR-DV6000 are configured in the Menu screens. The configured settings are saved in the memory of BR-DV6000 and retained even after power off.

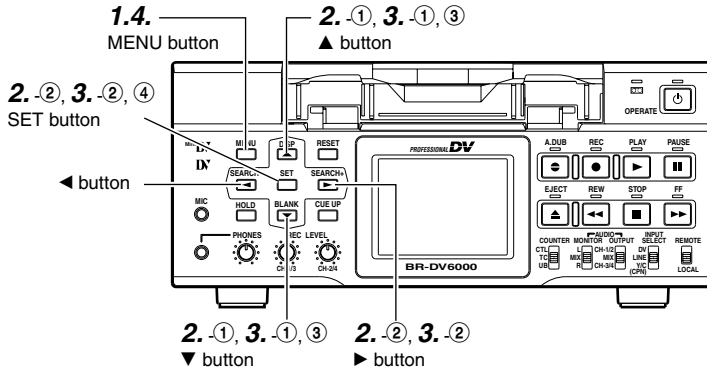

### TOP MENU screen

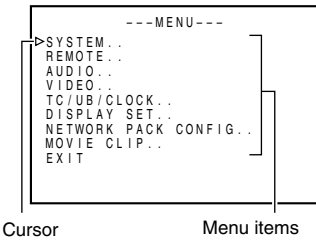

Perform the menu settings while viewing the display on the monitor connected to the VIDEO MONITOR OUT terminal or the LCD.

### ■ Set BR-DV6000 to the STOP or STILL mode.

#### 1. Displaying the TOP MENU screen.

Press the MENU button.

#### 2. Displaying the Menu screen items for setting.

- ① Press the ▲ or ▼ button to bring the cursor to the Menu screen item for setting.
- ② Press SET or the ► button.

Select EXIT of the TOP MENU screen to return to the normal screen.

#### 3. Setting the Menu item for setting.

- ① Press the ▲ or ▼ button to bring the cursor to the Menu screen item for setting.
- ② Press SET or the ► button.
  - The selected setting value blinks and becomes available for changing.
- ③ Press the ▲ or ▼ button to change the value.
- ④ Press the SET button to confirm the change.
  - Blinking stops and the new value is confirmed.
- ⑤ Repeat steps ① - ④ and continue setting as necessary.

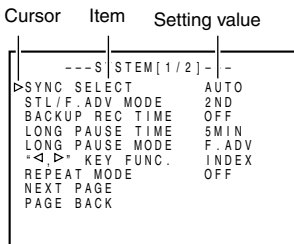

### SYSTEM (1/2) Menu screen

```
---SYSTEM[1/2]---
SYNC SELECT      AUTO
STL/F.ADV MODE  2ND
BACKUP REC TIME  OFF
LONG PAUSE TIME  5MIN
LONG PAUSE MODE  F.ADV
"◀,▶" KEY FUNC.  INDEX
REPEAT MODE      OFF
▶NEXT PAGE
PAGE BACK
```

```
---SYSTEM[2/2]---
DC IN MODE       OPE OFF
INDEX WRITE      ON
REPLICATION      OFF
REPLICATE DELAY  OFF
PB/DV IN        NTSC
FACTORY SETTING  CANCEL
DRUM HOUR METER  000.000
▶PAGE BACK
```

### SYSTEM (2/2) Menu screen

■ To display the Menu screen at the next level, bring the cursor to NEXT PAGE and press the SET or ► button.

■ To return to the previous Menu screen, do one of the following actions.

- Press the ▲ button.  
Or  
Select PAGE BACK and press the SET or ► button.

4. To return to the normal screen, do one of the following actions.

- Press the MENU button.  
Or  
Select EXIT in the TOP MENU screen and press the SET or ► button.

# MENU SCREENS

## - Description of the Menu screens -

In the following description of the Menus, ● indicates factory settings.

### TOP MENU screen

Item	Setting	Description
SYSTEM	—	Displays the menus related to the operating system of BR-DV6000. It also displays factory setting and the drum hour meter.
REMOTE	—	Displays the menus related to the remote controller.
AUDIO	—	Displays the menus related to the audio.
VIDEO	—	Displays the menus related to the video.
TC/UB/CLOCK	—	Displays the menu for setting time codes. Also displays the date/time setting screen.
DISPLAY SET	—	Displays the menus related to the monitor connected to the VIDEO MONITOR OUT terminal and the LCD.
NETWORK PACK CONFIG	—	Displayed if the network board SA-DV6000 (sold separately) is installed. For details, refer to the user's guide for SA-DV6000.
MOVIE CLIP	—	
EXIT	—	Return to the normal screen.

### SYSTEM Menu screens



The SYSTEM Menu consists of the following two screens (1/2 and 2/2).

#### ■ SYSTEM (1/2) menu

Item	Setting	Description
SYNC SELECT	● AUTO EXTERNAL	Use this item to select the synchronization signal if there is no input of synchronization signal to the SYNC IN terminal during playback. <b>AUTO</b> : Input video signal <b>EXTERNAL</b> : Internal synchronization signal (For details :  Page 29)
STL/F.ADV MODE	FIELD 1ST ● 2ND FRAME	Use this setting to select the still image for the STILL mode or frame-advance playback. <b>FIELD</b> : Displays the field image. During frame-advance playback, it displays the 1st and 2nd field images alternately. <b>1ST</b> : Displays the 1st field image. <b>2ND</b> : Displays the 2nd field image. <b>FRAME</b> : Displays the frame image.  — <b>Memo</b> — Images from the DV terminal will be the 1st field images regardless of the settings.



## SYSTEM Menu screens (continued)

Item	Setting	Description
<b>BACKUP REC TIME</b>	<ul style="list-style-type: none"> <li>● OFF</li> <li>25MIN</li> <li>55MIN</li> <li>75MIN</li> <li>115MIN</li> <li>175MIN</li> <li>265MIN</li> </ul>	<p>For setting backup recording time with DV input signals according to the tape length of the source unit:</p> <p><b>OFF</b> : No backup recording  <b>25MIN</b> : For a 30-minute source unit recording tape  <b>55MIN</b> : For a 60-minute source unit recording tape  <b>75MIN</b> : For a 80-minute source unit recording tape  <b>115MIN</b> : For a 120-minute source unit recording tape  <b>175MIN</b> : For a 180-minute source unit recording tape  <b>265MIN</b> : For a 270-minute source unit recording tape</p> <p>( Page 45 "Backup recording function")</p> <hr/> <p><b>Memo</b></p> <ul style="list-style-type: none"> <li>● This item is fixed to OFF when REPLICATION in the SYSTEM (2/2) Menu screen is set to DV. If this is set to other than OFF, REPLICATION cannot be set to DV.</li> <li>● Set this item to "OFF" if DV REC TRIGGER of GY-DV5000 is set to ON.</li> </ul>
<b>LONG PAUSE TIME</b>	<ul style="list-style-type: none"> <li>30SEC</li> <li>1MIN</li> <li>2MIN</li> <li>3MIN</li> <li>● 5MIN</li> </ul>	<p>Select the time when BR-DV6000 enters the TAPE PROTECTION mode if the unit has stayed at still, stop or recording pause for a prolonged period of time. The TAPE PROTECTION mode in at STILL can be selected from LONG PAUSE MODE:</p> <p><b>30SEC</b> : 30 seconds  <b>1MIN</b> : 1 minute      <b>3MIN</b> : 3 minutes  <b>2MIN</b> : 2 minutes      <b>5MIN</b> : 5 minutes</p> <hr/> <p><b>Memo</b></p> <p>To prevent the video head from clogged or the tape from being damaged, set as short a time as possible.</p>
<b>LONG PAUSE MODE</b>	<ul style="list-style-type: none"> <li>● F.ADV</li> <li>STBY-OFF</li> </ul>	<p>For selecting the action when BR-DV6000 stays at still for a long time.</p> <p>In the case of RECORDING PAUSE or STOP, it enters the standby-off status:</p> <p><b>F.ADV</b> : Frame-advances BR-DV6000 five times in the forward direction. On the 6th attempt, this mode stops it.  <b>STBY-OFF</b> : Stops BR-DV6000.</p>
<b>◀,▶ KEY FUNC.</b>	<ul style="list-style-type: none"> <li>INDEX</li> <li>● VAR</li> </ul>	<p>For selecting the function for the SEARCH+▶ button and SEARCH-◀ button.</p> <p><b>INDEX</b> : Performs index search. ( Page 52)  <b>VAR</b> : Changes the search speed during a search. ( Page 50)</p>
<b>REPEAT MODE</b>	<ul style="list-style-type: none"> <li>● OFF</li> <li>INDEX</li> <li>V. END</li> <li>TAPE END</li> </ul>	<p>For enabling/disabling repeat playback and selecting the type of repeat playback.</p> <p><b>OFF</b> : No repeat playback  <b>INDEX</b> : Repeat playback between the positions where index signals are recorded.  <b>V. END</b> : Repeat playback from the beginning of the tape to the position where video signal recording ends.  <b>TAPE END</b> : Repeat playback from the beginning to the end of the tape.</p>
<b>NEXT PAGE</b>		For displaying the SYSTEM (2/2) Menu screen.
<b>PAGE BACK</b>		For returning to the TOP MENU screen.

# MENU SCREENS - Description of the Menu screens - (continued)

## ■ SYSTEM (2/2) Menu

Item	Setting	Description
DC IN MODE	<ul style="list-style-type: none"> <li>● OPE OFF</li> <li>OPE ON</li> </ul>	<p>For selecting the action to perform when the power is supplied to the DC IN terminal:</p> <p><b>OPE OFF</b> : Sets BR-DV6000 to the OPERATE OFF mode.  <b>OPE ON</b> : Sets BR-DV6000 to the OPERATE ON mode.</p> <p><b>- Memo</b></p> <p>When the TIMER switch is set to REC or PLAY, the OPERATE ON mode becomes effective regardless of the setting of this item.</p>
INDEX WRITE	<ul style="list-style-type: none"> <li>OFF</li> <li>● ON</li> </ul>	<p>For enabling/disabling index signal recording.</p> <p><b>OFF</b> : No index signal  <b>ON</b> : Select here to record index signals.  It records an index signal automatically at the position where recording starts.</p>
REPLICATION	<ul style="list-style-type: none"> <li>● OFF</li> <li>SERIAL</li> <li>DV</li> </ul>	<p>For enabling /disabling output of REC commands from the SERIAL REMOTE OUT terminal or the DV terminal when BR-DV6000 is set to the PLAYBACK mode.</p> <p><b>OFF</b> : No output  <b>SERIAL</b> : Outputs from the SERIAL REMOTE OUT terminal. Use this setting when the SERIAL REMOTE OUT terminal is used for dubbing by another machine.  <b>DV</b> : Outputs from the DV terminal. Use this setting when the DV terminal is used for dubbing by another machine.</p> <p><b>- Memo</b></p> <p>This item cannot be set to DV when BACKUP REC TIME in the SYSTEM (1/2) Menu screen is set to other than OFF.  With this item set to DV, BACKUP REC TIME is fixed to OFF.</p>
REPLICATE DELAY	<ul style="list-style-type: none"> <li>● OFF</li> <li>1SEC</li> <li>2SEC</li> <li>3SEC</li> <li>4SEC</li> <li>5SEC</li> </ul>	<p>For setting the output timing of the REC command from the SERIAL REMOTE OUT terminal or the DV terminal when BR-DV6000 is set to the PLAYBACK mode.</p> <p><b>OFF</b> : Outputs when the unit is set to the PLAYBACK mode.  <b>1SEC - 5SEC</b> : Delays output timing by the set time (seconds).</p>
OPERATION LOCK	<ul style="list-style-type: none"> <li>● OFF</li> <li>ON</li> </ul>	<p>For enabling/disabling operation lock.</p> <p><b>OFF</b> : Turns off operation lock and the operation buttons of BR-DV6000 can be used.  <b>ON</b> : Turns on operation lock. The operation buttons and slide switches of BR-DV6000 are disabled except the OPERATE ON button and MENU operation. (Page 37)</p>
PB/DV IN	<ul style="list-style-type: none"> <li>PAL</li> <li>● NTSC</li> </ul>	<p>Set this menu according to the DV input signal and the signal format of the tape to be played.</p> <p><b>NTSC</b> : Select here when the signal format is NTSC.  <b>PAL</b> : Select here when PAL signals are input to the DV terminal or when a tape with PAL signals recorded is played.</p> <p><b>- Memo</b></p> <ul style="list-style-type: none"> <li>• With this menu set to PAL, analog signals cannot be recorded.</li> <li>• If the setting is changed, images cannot be produced properly for a while after the change.</li> <li>• Signal formats cannot be converted.</li> <li>• If this item is set to PAL, BR-DV6000 cannot be used as the player or recorder of an editing system.</li> </ul>
FACTORY SETTING	<ul style="list-style-type: none"> <li>● CANCEL</li> <li>EXECUTE</li> </ul>	<p>For enabling /disabling the factory setting for the Menu screens.</p> <p><b>CANCEL</b> : Disable the factory setting  <b>EXECUTE</b> : Enable the factory setting</p>
DRUM HOUR METER		<p>For displaying the time of drum usage.  * The cursor cannot be brought to this item.</p>
PAGE BACK		<p>For returning to the SYSTEM (1/2) Menu screen.</p>

## REMOTE Menu screens

The REMOTE Menu consists of the following two screens (1/2 and 2/2).

### ■ REMOTE (1/2) Menu screen

Item	Setting	Description
<b>REMOTE SEL 9P</b>	OFF <input checked="" type="radio"/> ON	For enabling/disabling the REMOTE1 (9-PIN) terminal when the REMOTE/LOCAL switch on the front panel is set to REMOTE. <b>OFF</b> : Control through RS-422A disabled <b>ON</b> : Control through RS-422A enabled
<p><b>Memo</b></p> <p>When the RS-232C board SA-K46U (sold separately) is installed, the name of this item changes to REMOTE SEL 232.            Use this setting to enable/disable the control via RS-232C when the REMOTE/LOCAL switch on the front panel is set to REMOTE.</p>		
<b>REMOTE SEL SER</b>	OFF <input checked="" type="radio"/> ON LOC+REM	For enabling/disabling control via the SERIAL REMOTE IN terminal. <b>OFF</b> : Control disabled regardless of the settings of the REMOTE/LOCAL switch <b>ON</b> : Control enabled only when the REMOTE/LOCAL switch is set to REMOTE. <b>LOC+REM</b> : Control enabled regardless of the settings of the REMOTE/LOCAL switch.
<b>REMOTE SEL DV</b>	OFF <input checked="" type="radio"/> ON LOC+REM	For enabling/disabling control via the DV terminal. <b>OFF</b> : Control disabled regardless of the settings of the REMOTE/LOCAL switch. <b>ON</b> : Control enabled only when the REMOTE/LOCAL switch is set to REMOTE. <b>LOC+REM</b> : Control enabled regardless of the settings of the REMOTE/LOCAL switch.
<b>REMOTE SEL JVC</b>	OFF <input checked="" type="radio"/> ON	For enabling/disabling the REMOTE 2 (12-PIN) terminal when the REMOTE/LOCAL switch on the front panel is set to REMOTE. <b>OFF</b> : Control through the JVC bus disabled <b>ON</b> : Control through the JVC bus enabled
<b>REMOTE SEL NET</b>	OFF <input checked="" type="radio"/> ON LOC+REM	For enabling/disabling control via the network board SA-DV6000 (sold separately). <b>OFF</b> : Control disabled regardless of the settings of the REMOTE/LOCAL switch. <b>ON</b> : Control enabled only when the REMOTE/LOCAL switch is set to REMOTE. <b>LOC+REM</b> : Control enabled regardless of the settings of the REMOTE/LOCAL switch.

# MENU SCREENS - Description of the Menu screens - (continued)

## REMOTE Menu screens (continued)

### ■ REMOTE (1/2) Menu screen (continued)

Item	Setting	Description
<b>LOCAL FUNCTION</b>	NO KEY EJECT ● STP + EJT ALL KEYS	For selecting the buttons of BR-DV6000 to be enabled in remote-controlling it with the REMOTE (1/2) terminals or the SERIAL REMOTE terminal: <b>NO KEY</b> : No button enabled. <b>EJECT</b> : Only the EJECT button enabled. <b>STP + EJT</b> : Only the STOP button and the EJECT button are enabled. <b>ALL KEYS</b> : All operation buttons are enabled. <b>- Memo</b> If OPERATION LOCK in the SYSTEM (2/2) Menu screen is set to ON, the buttons on BR-DV6000 will be disabled regardless of the setting here.
<b>PREROLL</b>	3SEC 5SEC ● 7SEC 10SEC	For setting the preroll time of BR-DV6000 in remote-controlling it with the REMOTE 1 terminal. Setting done with the editing remote controller prevails over other settings: <b>3SEC</b> : 3 seconds <b>5SEC</b> : 5 seconds <b>7SEC</b> : 7 seconds <b>10SEC</b> : 10 seconds <b>- Memo</b> To enhance editing precision, please set it to at least 7 seconds.
<b>NEXT PAGE</b>		For displaying the REMOTE (2/2) Menu screen.
<b>PAGE BACK</b>		For returning to the TOP MENU screen.

### ■ REMOTE (2/2) Menu screen

Item	Setting	Description
<b>REM FF/REW MODE</b>	● FF/REW SEARCH	For setting the action to be performed when the 9-PIN REMOTE terminal, 12-PIN REMOTE terminal, RS-232C terminal or DV terminal received an FF/REW command: <b>FF/REW</b> : Sets BR-DV6000 to perform FF/REW when an FF/REW command is received. Normal setting. <b>SEARCH</b> : Sets BR-DV6000 to perform searching when an FF/REW command is received. Use this setting if the search (cue up) function does not work properly.
<b>REM STOP SEL</b>	● EE PB	For setting the action to be performed when the 9 PIN REMOTE terminal, 12-PIN REMOTE terminal, RS-232C terminal or DV terminal received a STANDBY ON command: <b>EE</b> : Sets BR-DV6000 to the EE mode. (It goes into the STOP mode.) <b>PB</b> : Sets BR-DV6000 to the PLAY mode. (It goes into the STILL mode.)

■ REMOTE (2/2) Menu screen (continued)

Items	Setting	Description
<b>PB START DELAY</b>	<ul style="list-style-type: none"> <li>● 0F</li> <li> </li> <li>15F</li> </ul>	<p>For adjusting the edit timing. With the remote controller in use, if the start points of edit are not concurrent, adjust the playback startup timing:</p> <p><b>0F</b> : No correction.  <b>1F to 15F</b> : Delays the timing by the number of frames set by the user. When BR-DV6000 is connected to an editing remote controller with no bump function, use this setting to adjust the editing precision.</p>
<b>SYNCHRONIZATION</b>	<ul style="list-style-type: none"> <li>OFF</li> <li>● ON</li> </ul>	<p>For enabling/disabling the bump function when BR-DV6000 is connected to an editing remote controller:</p> <p><b>OFF</b> : No synchronization.  <b>ON</b> : Performs synchronization. The editing precision is enhanced. Please set the pre-roll time to at least 7 seconds.</p>
<b>CONTROLLER SEL</b>	<ul style="list-style-type: none"> <li>● TYPE1</li> <li>TYPE2</li> <li>TYPE3</li> <li>TYPE4</li> <li>TYPE5</li> <li>TYPE6</li> <li>TYPE7</li> </ul>	<p>For setting the type of controller to be connected when remote control is enabled with the RS-422A interface:</p> <p><b>TYPE1</b> : RM-G820  <b>TYPE2</b> : RM-G860 (set the preroll time to at least 10 seconds)  <b>TYPE3</b> : AG-A850  <b>TYPE4</b> : RM-450,PVE-500  <b>TYPE5 - TYPE7</b> : (Not in use)</p>
<b>FOOT SW</b>	<ul style="list-style-type: none"> <li>● OFF</li> <li>L EDGE</li> <li>H EDGE</li> <li>L LEVEL</li> </ul>	<p>For setting when an external switch (e.g., a footswitch) is connected to the SERIAL REMOTE terminal. Before operating an external switch (footswitch) with L EDGE or H EDGE, turn BR-DV6000 to the RECORDING PAUSE or RECORDING mode:</p> <p><b>OFF</b> : For when the external switch is not used.  <b>L EDGE</b> : Recording and recording pause is switched at the LOW edge of the external switch signal.  <b>H EDGE</b> : Recording and recording pause is switched at the HIGH edge of the external switch signal.  <b>L LEVEL</b> : Record at the LOW edge and pause recording at the HIGH edge of the external switch signal.</p>
<b>PAGE BACK</b>		Return to the REMOTE (1/2) Menu screen.

## MENU SCREENS - Description of the Menu screens - (continued)

### AUDIO Menu screen

Item	Setting	Description
<b>AUDIO MODE</b>	<input checked="" type="radio"/> 48 K <input type="radio"/> 32 K	For selecting the audio sampling frequency for recording. <b>48 K</b> : Records at 48 kHz. It records in the 2-channel stereo mode. No audio dubbing allowed. <b>32 K</b> : Records at 32 kHz. It records in the 4-channel mode. To perform audio dubbing on CH3 and CH4 later, use this setting. <hr/> <b>— Memo —</b> Setting of this item is not required for DV signal input.
<b>A.OUT AT SEARCH</b>	<input type="radio"/> OFF <input checked="" type="radio"/> ON	For enabling/disabling audio output from this AUDIO OUT terminal during searches. <b>OFF</b> : Output off. <b>ON</b> : Output on.
<b>AUDIO INPUT SEL</b>	<input type="radio"/> XLR <input checked="" type="radio"/> RCA	Use this setting when the XLRIN board SA-X61U (sold separately) is installed. For selecting the audio input terminal. <b>XLR</b> : Audio input terminal of SA-X61U <b>RCA</b> : AUDIO INPUT terminal of the unit
<b>AUDIO OUT LEV</b>	<input type="radio"/> -12 dB <input checked="" type="radio"/> -20 dB	For selecting the level for playback audio output. <b>-12 dB</b> : Select here to reduce the analog sound output level. It will be reduced by 8 dB. <b>-20 dB</b> : Usually, this setting is used.
<b>V.FADE</b>	<input type="radio"/> OFF <input checked="" type="radio"/> ON	For enabling/disabling the V.Fade function, which reduces sound noise in playback that is produced at jointed parts of recording. <b>OFF</b> : V.FADE function disabled. <b>ON</b> : V.FADE function enabled.
<b>PAGE BACK</b>		For returning to the TOP MENU screen.

## VIDEO Menu screen

Item	Setting	Description
<b>VIDEO INPUT SEL</b>	● Y/C COMPONENT	For selecting the input video signals when the INPUT SELECT switch on the front panel is set to Y/C (CPN). <b>Y/C</b> : YC separate signals <b>COMPONENT</b> : Component video signals
<b>SET UP (NTSC)</b>	● OFF ON	For enabling/disabling the application of setups to analog video signals (composite, Y/C and component). (During recording and playback) <b>OFF</b> : Does not apply setups. <b>ON</b> : Applies setups. <b>- Memo</b> _____ The application of setups on playback or recorded video signals must match the setting of SET UP. Otherwise, if dubbing is repeatedly performed, the hue and brightness of the video may not appear normal.
<b>BLACK BURST</b>	● OFF ON	For enabling/disabling output of black burst signals of the built-in signal generator. (When analog input is selected) <b>OFF</b> : Output off <b>ON</b> : Output on. In the RECORDING mode, black burst signals will be recorded.
<b>PAGE BACK</b>		For returning to the TOP MENU screen.

## MENU SCREENS - Description of the Menu screens - (continued)

### TC/UB/CLOCK Menu screens

The TC/UB/CLOCK Menu consists of the following two screens. (1/2 and 2/2)

#### ■ TC/UB/CLOCK (1/2) Menu screen

Item	Setting	Description
<b>TCG SOURCE</b>	<ul style="list-style-type: none"> <li>● INTERNAL</li> <li>EXTERNAL</li> </ul>	For selecting the source of the time code generator. <b>INTERNAL</b> : BR-DV6000 built-in time code generator <b>EXTERNAL</b> : Time code generator connected to the TIME CODE IN terminal
<b>TCG SELECT</b>	<ul style="list-style-type: none"> <li>PRESET</li> <li>● REGEN</li> </ul>	For selecting the time code generator mode. <b>PRESET</b> : PRESET mode <b>REGEN</b> : REGENERATION mode.
<b>TCG MODE</b>	<ul style="list-style-type: none"> <li>● REC-RUN</li> <li>FREE-RUN</li> </ul>	For selecting the running mode of the time code generator. * Select here in the PRESET mode. <b>REC-RUN</b> : RECORD RUN mode. <b>FREE-RUN</b> : FREE RUN mode
<b>NDF/DF (NTSC)</b>	<ul style="list-style-type: none"> <li>NON DROP</li> <li>● DROP</li> </ul>	For selecting the framing mode of the time code generator. (NTSC only) * Select here in the PRESET mode. <b>NON DROP</b> : NON-DROP mode <b>DROP</b> : DROP-FRAME mode
<b>DF BIT (PAL)</b>	<ul style="list-style-type: none"> <li>OFF</li> <li>● ON</li> </ul>	For selecting whether to record drop-frame bits. (Only for E model) <b>OFF</b> : No recording <b>ON</b> : Recording
<b>TC DUPLICATE</b>	<ul style="list-style-type: none"> <li>● OFF</li> <li>AUTO</li> <li>NON DROP</li> </ul>	For selecting the type of time code to be recorded with DV signal input. <b>OFF</b> : Records time code of the built-in time code generator of BR-DV6000 <b>AUTO</b> : Records the time code input to the DV IN terminal. The framing mode of the time code will be set automatically to the framing of the time code input. <b>NON DROP</b> : Records the time code input to the DV IN terminal. The framing mode of the time code is fixed to non-drop framing. (NTSC only) Use this setting for dubbing tapes recorded with BR-DV600, GY-DV500 or GY-DV550 in the NON-DROP FRAME mode. (NTSC only)
<b>TC OFFSET</b>	<ul style="list-style-type: none"> <li>● OFF</li> <li>+1F</li> <li>+2F</li> <li>-2F</li> <li>-1F</li> </ul>	For setting up the timing when time code data from the 9-PIN REMOTE terminal of BR-DV6000 to the editing remote controller are output. <b>OFF</b> : Normal setting <b>+1F</b> : Sets the timing to 1 frame faster. <b>+2F</b> : Sets the timing to 2 frames faster. <b>-2F</b> : Sets the timing to 2 frames slower. <b>-1F</b> : Sets the timing to 1 frame slower.
<b>NEXT BACK</b>		For displaying the TC/UB/CLOCK (2/2) Menu screen.
<b>PAGE BACK</b>		For returning to the TOP MENU screen.



■ TC/UB/CLOCK (2/2) Menu screen

Item	Setting	Description
U-BIT (PAL)	OFF <input checked="" type="radio"/> ON	For selecting whether to record user's bit. (Only for E model) <b>OFF</b> : No recording <b>ON</b> : Recording
DATE REC	<input checked="" type="radio"/> OFF ON	For selecting whether to add date/time data to the image to be recorded. <b>OFF</b> : No recording <b>ON</b> : Recording date/time on-screen display description. For this to be enabled, the following settings are required. <ul style="list-style-type: none"> <li>• Set DISPLAY in the DISPLAY (1/2) Menu screen to ON.</li> <li>• Set TIME/DATE in the DISPLAY (2/2) Menu screen to other than OFF.</li> </ul> <div style="border: 1px solid black; padding: 5px; margin-top: 10px;"> <p><b>Memo</b></p> <p>With DV signal input, date/time data are not recorded.</p> </div>
CLOCK ADJUST		For displaying the date/time setting screen For setting, refer to page 40 "Setting date/time".
PAGE BACK		For returning to the TC/UB/CLOCK(1/2) Menu screen .

## MENU SCREENS - Description of the Menu screens - (continued)

### DISPLAY Menu screens

The DISPLAY menu consists of 2 screens (1/2 and 2/2)

#### ■ DISPLAY (1/2) Menu screen

Item	Setting	Description
LCD BRIGHTNESS	MAX +4 +3	For adjusting the brightness of the LCD. A bigger value increases brightness.
LCD CHROMA	+2 +1	For adjusting the concentration level of the color of the LCD. A bigger value increases color concentration.
LCD CONTRAST	● 0 -1 -2 -3 -4 MIN	For adjusting the LCD contrast. A bigger value increases contrast.
LCD AUTO OFF	OFF ● 30MIN 1HOUR 2HOUR	For selecting whether to turn off the LCD display automatically when it is not to be used for a long time. <b>OFF</b> : No auto OFF <b>30MIN</b> : Auto OFF after 30 minutes <b>1HOUR</b> : Auto OFF after 1 hour <b>2HOUR</b> : Auto OFF after 2 hours <hr/> <b>— Memo</b> During recording or playback, the LCD display stays on regardless of this setting.
DISPLAY	OFF ● ON AUTO	For turning on/off on-screen status display on the monitor connected to the VIDEO MONITOR OUT terminal or the LCD. <b>OFF</b> : No on-screen status display. Only video is displayed. <b>ON</b> : Always shows on-screen status display. <b>AUTO</b> : Shows on-screen status display for about 4 seconds during mode changes.
COUNTER POSI.	● LOWER-R LOWER-L UPPER-R UPPER-L CENTER	For selecting the counter display position (CTL counter, time code and user's bit) of the monitor or the LCD. <b>LOWER-R</b> : Lower right <b>LOWER-L</b> : Lower left <b>UPPER-R</b> : Upper right <b>UPPER-L</b> : Upper left <b>CENTER</b> : Center
NEXT PAGE		For displaying the DISPLAY (2/2) Menu screen.
PAGE BACK		For returning to the TOP MENU screen.

## ■ DISPLAY (2/2) Menu screen

Item	Setting	Description
<b>TIME CODE</b>	<input type="radio"/> OFF <input checked="" type="radio"/> ON	For enabling/disabling the time code display on the monitor or the LCD. <b>OFF</b> : No display <b>ON</b> : Display
<b>VTR MODE</b>	<input type="radio"/> OFF <input checked="" type="radio"/> ON	For enabling/disabling the VCR mode on the monitor or the LCD. <b>OFF</b> : No display <b>ON</b> : Display
<b>TAPE REMAIN</b>	<input type="radio"/> OFF <input checked="" type="radio"/> ON	For enabling/disabling the display of the remaining time of the tape on the monitor or the LCD. <b>OFF</b> : No display <b>ON</b> : Display
<b>TIME/DATE</b>	<input type="radio"/> OFF <input type="radio"/> TIME <input type="radio"/> DATE <input checked="" type="radio"/> DATE+TM	For enabling/disabling the time/date display on the monitor or the LCD and selecting the display format. <b>OFF</b> : No display <b>TIME</b> : Time display only <b>DATE</b> : Date display only <b>DATE+TM</b> : Date/Time display
<b>AUDIO INFO.</b>	<input type="radio"/> OFF <input checked="" type="radio"/> ON	For enabling/disabling the display of audio channel or sampling frequency on the monitor or the LCD. <b>OFF</b> : No display <b>ON</b> : Display
<b>EDIT INFO.</b>	<input type="radio"/> OFF <input checked="" type="radio"/> ON	For selecting whether to display the edit mode on the monitor or the LCD. <b>OFF</b> : No display <b>ON</b> : Display
<b>DATE STYLE</b>	<input type="radio"/> YY/MM/DD <input checked="" type="radio"/> MM/DD/YY <input type="radio"/> DD/MM/YY	For selecting the date display format. <b>YY/MM/DD</b> : Year/Month/Day <b>MM/DD/YY</b> : Month/Day/Year <b>DD/MM/YY</b> : Day/Month/Year
<b>TIME STYLE</b>	<input checked="" type="radio"/> 24HOUR <input type="radio"/> 12HOUR	For selecting the display style of time. <b>24HOUR</b> : 24-hour mode <b>12HOUR</b> : 12-hour mode
<b>PAGE BACK</b>		For returning to the DISPLAY (1/2) screen.

# RS-232C INTERFACE

# - Command tables -

This section provides information on programming VCR operations via the RS-232C interface.

## ■ BASIC TABLE

→ Low ↑ High	0	1	2	3	4	5	6	7	8	9	A	B	C	D	E	F
0		Complete	Error	Cassette Out		Not Target					ACK	NAK				
1																
2																
3											Play	Fwd Shtl x2	Fwd Shtl x0.2	Fwd Still	Fwd Shtl x10	Stop
4	Enter	Clear Error	CueUp with Data				In Shift +	In Shift -	Out Shift +	Out Shift -	Rev Shtl x1	Rev Shtl x2	Rev Shtl x0.2	Rev Still	Rev Shtl x10	Still
5	In Entry	Out Entry	In Flag Reset	Out Flag Reset	In Flag Recall	Out Flag Recall	Clear		Go-to In	Go-to Out	Memory	Memory Search				
6								Status Sense								
7																
8															Date Preset	Clock Preset
9																
A	Standby On	Standby Off	Preroll	Eject								Ff	Rew	Fwd Field Step	Rev Field Step	
B			CueUp with Data			Fwd Shtl	Rev Shtl								Date Data Sense	Clock Data Sense
C	Auto Edit	Preview	Review		Full-EE On	EE Off			Select EE On	Select EE Off	Rec	Rec Pause	Adb	Adb Pause	Edit On	Edit Off
D						Preroll Tm Sense	Status Sense	Tc Data Sense	CTL Data Sense	In Data Sense	Out Data Sense	UB Data Sense	JVC Status Sense			
E	TC Preset	UB Preset	CTL Data Reset	In Data Preset	Out Data Preset	Edit Preset	Preroll Tm Preset	Timer Mode Select					Memory Sw Preset			
F						JVC Tbl 1 Select	Basic Tbl Select				Rec/Dub Request	Vtr Ind				

## ■ JVC TABLE1

→ Low ↑ High	0	1	2	3	4	5	6	7	8	9	A	B	C	D	E	F
0		Complete	Error	Cassette Out		Not Target					ACK	NAK				
1																
2																
3											Play					Stop
4	Enter	Clear Error					In Shift +	In Shift -	Out Shift +	Out Shift -						Still
5	In Entry	Out Entry	In Flag Reset	Out Flag Reset	In Flag Recall	Out Flag Recall	Clear		Go-to In	Go-to Out	Memory	Memory Search				
6								Status Sense								
7			Rom Version									Operate On	Operate Off			
8															Date Preset	Clock Preset
9																
A	Standby On	Standby Off	Preroll	Eject								Ff	Rew	Fwd Field Step	Rev Field Step	
B	Viss Fwd	Viss Rev	Play After CueUp			Fwd Shtl	Rev Shtl								Date Data Sense	Clock Data Sense
C					Full-EE On	EE Off					Rec	Rec Pause	Adb	Adb Pause		
D		Device Type Request		Memory Sw Sense	Tape Rem Sense			Status Sense	Tc Data Sense	CTL Data Sense				JVC Status Sense		
E			CTL Data Reset	In Data Preset	Out Data Preset			Timer Mode Select						Memory Sw Preset		
F						JVC Tbl 1 Select	Basic Tbl Select				Rec/Dub Request	Vtr Ind				

# RS-232C INTERFACE

## - RS-232C specifications -

### ● 9PIN D-Sub

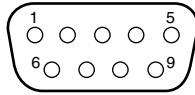

Pin No.	Signal	Operation	Direction of signal
2	RxD	Receive data	VCR←PC
3	TxD	Transmit data	VCR→PC
4	DTR	Data terminal ready	VCR→PC
5	GND	Signal grounding	
6	DSR	Data set ready	VCR←PC

**Memo** : "PC" means a controller such as a personal computer.

- Mode : Non-synchronous
- Character length : 8 bits
- Parity check : None
- Start bit : 1
- Stop bit : 1
- Data rate : 9600bps
- Bit configuration

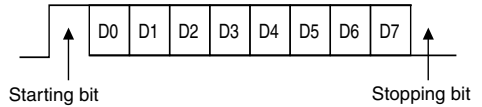

## ASCII code table

Use this table to represent the values or alphabets in ASCII with the RS-232C interface.

	0	1	2	3	4	5	6	7	8	9	A	B	C	D	E	F
0			SP	0		P		p								
1				1	A	Q	a	q								
2				2	B	R	b	r								
3				3	C	S	c	s								
4				4	D	T	d	t								
5				5	E	U	e	u								
6				6	F	V	f	v								
7				7	G	W	g	w								
8				8	H	X	h	x								
9				9	I	Y	i	y								
A					J	Z	j	z								
B					K		k									
C					L		l									
D					M		m									
E					N		n									
F					O		o									

# RS-232C INTERFACE

## - RS-232C commands -

An optional RS-232C interface board SA-K46U can be installed to BR-DV6000 and connected to a personal computer. Data transmitted and received via the RS-232C interface enables the PC to control the VCR and gather status and operating information.

### ■ Preparation

To control the VCR by the RS-232C interface, the following settings are required.

- Set REMOTE SEL 232 in the REMOTE (1/2) Menu screen to ON.
- Set the REMOTE/LOCAL switch on the front panel to REMOTE.

### ● Command tables

BR-DV6000 is controlled according to the following two command tables (BASIC, JVC-1).

Command	Description
F6	JVC-1 TABLE ON : Hereafter, JVC TABLE-1 is followed.
F7	BASIC TABLE ON : Hereafter, BASIC TABLE is followed. JVC TABLE-1 is turned OFF.

### ● VCR operation commands

These commands are used to operate the VCR. When a command is received correctly, the VCR returns ACK (0Ah) and enters the mode corresponding to the command.

(Example) Playback

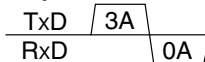

Blank "Table" boxes below denote that these commands exist for both command tables.

B : BASIC TABLE,

J1 : JVC TABLE-1

Table	Command	Description
	3A	PLAY : Play
B	3B	FWD x 2 : 2x play
B	3C	FWD x 0.2 : 0.2x play
B	3D	F-STILL : Pause
B	3E	FWD x 9/10 : 9(10) x play (PAL)
	3F	STOP : Stop
	46	IN SHIFT + : Shifts the IN point to the + direction.
	47	IN SHIFT - : Shifts the IN point to the - direction.
	48	OUT SHIFT + : Shifts the OUT point to the + direction.
	49	OUT SHIFT - : Shifts the OUT point to the - direction.
B	4A	REV x 1 : Reverse play
B	4B	REV x 2 : 2x reverse play
B	4C	REV x 0.2 : 0.2x reverse play
B	4D	R-STILL : Pause
B	4E	REV x 9/10 : 9(10) x reverse play
	4F	STILL : Pause
	50	IN ENTRY : Registers the current time as the IN point.
	51	OUT ENTRY : Registers the current time as the OUT point.
	52	IN FLAG RESET : Cancels the registered IN point.
	53	OUT FLAG RESET : Cancels the registered OUT point.
	54	IN FLAG RECALL : Validates the cancelled IN point.
	55	OUT FLAG RECALL : Validates the cancelled OUT point.
	58	GO TO IN : Cues up the point specified with IN ENTRY (50) and IN DATA PRESET (E3). When the tape is cued, COMPLETE (01) is returned. When the specified point cannot be found, NOT TARGET (05) is returned.

Table	Command	Description
	59	GO TO OUT : Cues up the point specified with OUT ENTRY (51) and OUT DATA PRESET (E4). When the tape is cued, COMPLETE (01) is returned. When the specified point cannot be found, NOT TARGET (05) is returned.
	5A	MEMORY : Registers the current counter value as the cue-up point of MEMORY SEARCH (5B).
	5B	MEMORY SEARCH : Cues up the point specified with MEMORY (5A). When the tape is cued, COMPLETE (01) is returned. When the specified point cannot be found, NOT TARGET (05) is returned.
J1	7B	OPERATE ON : Operating mode ON
J1	7C	OPERATE OFF : Operating mode OFF
	A0	STANDBY ON : Standby ON
	A1	STANDBY OFF : Standby OFF
	A2	PREROLL : Preroll
	A3	EJECT : Ejects the cassette tape. When the tape has been ejected, CASSETTE OUT (03H) is returned.
	AB	FF : Fast-forwards the tape.
	AC	REW : Rewinds the tape.
	AD	F-FIELD STEP : Advances one frame. This command should be transmitted in the Play-Pause mode. Field-advances when STL/F.ADV MODE is set to FIELD. Otherwise, this command frame-advances.
	AE	R-FIELD STEP : Reverses one frame. This command should be transmitted in the Play-Pause mode. Field-advances when STL/F.ADV MODE is set to FIELD. Otherwise, frame-advances.

Table	Command	Description
J1	B0	<p>VISS FORWARD : Index search in the forward direction. For the index search position, enter a 3-digit number (001-099) following the command.</p> <p>When a 3-digit number has been entered, index search starts.</p> <p>If ENTER (40H) is transmitted before all three digits are entered, the remaining digit(s) are considered as "0" (30H), and index search starts.</p>
J1	B1	<p>VISS REV : Index search in the reverse direction. For the index search position, enter a 3-digit number (001-099) following the command.</p> <p>When a 3-digit number has been entered, index search starts.</p> <p>If ENTER (40H) is transmitted before all three digits are entered, the remaining digit(s) are considered as "0" (30H), and index search starts.</p>
B	B2	<p>CUE UP WITH DATA : Use this command to cue up a specified point on the tape. When the tape is cued, COMPLETION is returned and the Pause mode becomes effective.</p> <p>To specify a cue point, transmit the time data (hour: minute: second: frame, a total of 8 bytes with 2 bytes for each) following this command. By transmitting ENTER (40H) with the time data, transmission of lower data becomes unnecessary. In such a case, "0" is transmitted. If the specified point cannot be found, NOT TARGET (05H) is returned.</p>
J1	B2	<p>CUE UP AND PLAY WITH DATA: Use this command to cue up a specified point on the tape. When the tape is cued, COMPLETION is returned and the Play mode becomes effective.</p> <p>To specify a cue point, transmit the time data (hour: minute: second: frame, a total of 8 bytes with 2 bytes for each) following this command. By transmitting ENTER (40H) with the time data, transmission of lower data becomes unnecessary. In such a case, "0" is transmitted. If the specified point cannot be found, NOT TARGET (05H) is returned.</p>

Table	Command	Description																										
J1	B5	<p>F-SHUTTLE : Shuttle play. The search speed is specified by sending the speed code data after this command (see the table below).</p> <p style="text-align: center;"><b>Speed code table (Supported speed only)</b></p> <table border="1" style="margin-left: auto; margin-right: auto;"> <thead> <tr> <th>Speed code</th> <th>Search speed</th> </tr> </thead> <tbody> <tr> <td>30h</td> <td>STILL</td> </tr> <tr> <td>31h</td> <td>0.1</td> </tr> <tr> <td>32h</td> <td>0.2</td> </tr> <tr> <td>33h</td> <td>0.33</td> </tr> <tr> <td>34h</td> <td>0.5</td> </tr> <tr> <td>35h</td> <td>1</td> </tr> <tr> <td>36h</td> <td>2</td> </tr> <tr> <td>37h</td> <td>5</td> </tr> <tr> <td>38h</td> <td>10</td> </tr> <tr> <td>39h</td> <td>20</td> </tr> <tr> <td>3Bh</td> <td>X0.90</td> </tr> <tr> <td>3Ch</td> <td>X1.07</td> </tr> </tbody> </table> <p>3Bh and 3Ch are effective only for B5.</p>	Speed code	Search speed	30h	STILL	31h	0.1	32h	0.2	33h	0.33	34h	0.5	35h	1	36h	2	37h	5	38h	10	39h	20	3Bh	X0.90	3Ch	X1.07
Speed code	Search speed																											
30h	STILL																											
31h	0.1																											
32h	0.2																											
33h	0.33																											
34h	0.5																											
35h	1																											
36h	2																											
37h	5																											
38h	10																											
39h	20																											
3Bh	X0.90																											
3Ch	X1.07																											
	B6	<p>R-SHUTTLE : Shuttle reverse play. The search speed is specified by sending the speed code data after this command (see the table above).</p>																										
B	CO	<p>AUTO EDIT KEY : Audio editing with the VCR.</p> <ul style="list-style-type: none"> <li>It is required that the editing channel is selected in [E5: Edit Preset].</li> <li>This audio editing command must be used with [FA: Rec Request].</li> <li>Preroll time can be set with [E6: Preroll Time Preset]. Without this setting, the VCR menu switch settings are followed.</li> <li>Upon the completion of auto editing, the VCR returns [01: Complete].</li> </ul>																										
B	C1	<p>PREVIEW KEY : Preview with the VCR</p> <ul style="list-style-type: none"> <li>It is required that the editing channel is selected in [E5: Edit Preset].</li> <li>This preview command must be used with [FA: Rec Request].</li> <li>Preroll time can be set with [E6: Preroll Time Preset]. Without this setting, the VCR menu switch settings are followed.</li> <li>Upon the completion of preview, the VCR returns [01: Complete].</li> </ul>																										

# RS-232C INTERFACE

## - RS-232C commands - (continued)

Table	Command	Description
B	C2	REVIEW KEY : Review with the VCR <ul style="list-style-type: none"> <li>It is required that [C0: Auto Edit] is complete.</li> <li>Preroll time can be set with [E6: Preroll Time Preset]. Without this setting, the VCR menu switch settings are followed.</li> <li>Upon the completion of review, the VCR returns [01: Complete].</li> </ul>
	C4	Full EE mode ON
	C5	Full EE mode OFF
B	C8	SELECT EE ON : Input signal check for the editing channel selected in [E5: Edit Preset].
B	C9	SELECT EE OFF : EE check release.
	CA	REC : Recording. This command is transmitted after transmitting REC/DUB REQUEST.
	CB	REC PAUSE : Record pause. This command is transmitted after transmitting REC/DUB REQUEST.
	CC	A.DUB : Audio dubbing. This command is transmitted during A.DUB PAUSE after transmitting REC/DUB REQUEST.
	CD	A.DUB PAUSE : Audio dubbing pause. This command is transmitted during audio dubbing after transmitting REC/DUB REQUEST.
	E2	COUNTER RESET : Counter reset E2 40.
	FA	REC/DUB REQUEST : Recording request. (Use this command with a recording command).

### • Return commands from the VCR

When the VCR received commands properly, it returns the following commands.

Command	Description
01	COMPLETION : The VCR outputs this command when the operation specified with Cue Up with Data, Preroll, Auto Edit, etc. is complete.
03	CASSETTE OUT : The VCR outputs this command when RS-232C ejected the tape.
05	NOT TARGET : The VCR outputs this command when the operation specified with Cue Up with Data/Preroll failed to be completed.
0A	ACK : This command is returned when a defined command is received.

### • Error commands

These are commands that are returned when transmitted data cannot be received by the VCR properly. Commands that release errors are also available.

Command	Description
02	ERROR : This command is returned when the VCR receives an invalid command after the second byte of a multi-byte command. In this case, even if other commands are sent continuously, no command can be accepted. However, status sense codes can be received. To release errors, use the following commands.
41	ERROR CLEAR : Clears the last transmitted byte. Also use this command to release errors.
56	CLEAR : Cancels whole commands. Also use this command to release errors.
0B	NAK : Returned when the VCR receives an undefined command for the first byte or a command specifying a function not available for the VCR. Releasing the error with the CLEAR command is not necessary. Send the correct command.



‡ **Example of CLEAR ERROR**

Specify the cue-up point at 1:10:10:25.

The specified data after the CUE UP WITH DATA command is invalid. Correct it with the CLEAR ERROR command.

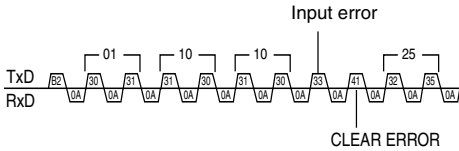

● **Information gathering (sense) commands**

These commands are used to check the VCR operation status.

When a command corresponding to requested information is received by the VCR, data is returned in 1-byte packets. The number of bytes returned differs depending on the command.

Table	Command	Description
J1	72	ROM VERSION : For checking the RS-232C interface-related ROM version. 3-byte data is returned.
	BE	DATA SENSE : For checking the VCR's date data. The data is returned in order of month, date and year. During playback, the time data on the tape is returned.
	BF	TIME SENSE : For checking the VCR's time data. The data is returned in order of hour, minute and second. During playback, the time data on the tape is returned.
J1	D1	DEVICE TYPE : For checking the device type. D: 44h, V:56h, 6:36h, K:4Bh
J1	D4	TAPE REMAIN SENSE : For checking the tape remaining time. 3-byte data is returned showing the hour (one's place) and minutes (ten's place and one's place).
B	D6	PREROLL SENSE : For checking the preroll time. 2-byte data is returned showing the seconds (ten's place and one's place).
	D7	STATUS SENSE : For checking the status. Refer to STATUS SENSE. (☞ Page 90)

Table	Command	Description
	D8	CURRENT TC SENSE : For checking the time code data. The data is returned in the order of hour, minute, second and frame. Effective when the counter mode is set to TC.
	D9	CURRENT CTL SENSE : For checking the CTL data. The uppermost digit shows positive or negative. Effective when the counter mode is set to CTL.
B	DA	IN DATA SENSE : For checking the edit-in position. The data is returned in the order of hour, minute, second and frame.
B	DB	OUT DATA SENSE : For checking the edit-out position. The data is returned in the order of hour, minute, second and frame.
B	DC	CURRENT TC UB SENSE : For checking the user's bit data. Data A from F is represented with ASCII code 41h to 46h. Effective when the counter mode is set to UB.
	DD	JVC STATUS SENSE : For checking the status. Refer to JVC STATUS SENSE. (☞ Page 91)
	FB	VTR IND : For checking VCR connection.

# RS-232C INTERFACE – RS-232C commands – (continued)

## ■ D7: STATUS SENSE

This section describes 5-byte data that are returned when the STATUS SENSE (D7H) command is sent.

### ● First byte

Bit No.	Status: If the bit is 1
7	Always 1
6	Always 0
5	SHORT FF/REW : In short FF or short REW
4	REC INHIBIT : Recording prohibited
3	CASSETTE OUT : No cassette tape loaded
2	SERO LOCK : Servo locked
1	Undefined : Always 0
0	ERROR : Error occurring

### ● Second byte

Bit No.	Status: If the bit is 1
7	VIDEO EE : Video output in the EE mode
6	AUD EE : Audio 1 output in the EE mode
5	VIDEO MUTE : Video signals muted
4	AUD MUTE : Audio signals muted
3	WARNING : Problem with the VCR
2	DEW : Condensation in the VCR
1	TAPE BEGIN : Short FF at the tape beginning.
0	TAPE END : Short REW at the tape end

### ● Third byte

Bit No.	Status: If the bit is 1
7	TIMER PLAY : TIMER switch set to PLAY
6	TIMER REC : TIMER switch set to REC
5	Unused : Always 0
4	REPEAT : REPEAT PLAYBACK mode ON
3	Unused : Always 0
2	REPEAT MODE : Repeat playback in operation
1	SEARCH MODE : VCR being cueing-up/prerolling
0	Unused : Always 0

### ● Fourth byte

Bit No.	Status: If the bit is 1
7	PLAY MODE : VCR playing
6	FF MODE : VCR fast-forwarding
5	REW MODE : VCR rewinding
4	STOP MODE : VCR stopped
3	STAND BY MODE : VCR on standby
2	EJECT : Cassette tape being ejected
1	REC MODE : VCR recording
0	ADB MODE : VCR audio dubbing

### ● Fifth byte

Bit No.	Status: If the bit is 1
7	PAUSE MODE : VCR paused
6	Unused : Always 0
5	SHUTTLE FWD : VCR forward shuttle-searching
4	SHUTTLE REV : VCR reverse shuttle-searching
3	SPEED CODE3 : Refer to the following table.
2	SPEED CODE2 : Refer to the following table.
1	SPEED CODE1 : Refer to the following table.
0	SPEED CODE0 : Refer to the following table.

### Search speed table (Supported speed only)

Search speed	Speed code (Bit No.)			
	3	2	1	0
STILL	0	0	0	0
0.1	0	0	0	1
0.2	0	0	1	0
0.3	0	0	1	1
0.5	0	1	0	0
1	0	1	0	1
2	0	1	1	0
5	0	1	1	1
9 (10)	1	0	0	0
20	1	0	0	1

( ) : PAL

## ■ DD: JVC STATUS SENSE

This section describes 4-byte data that are returned when the STATUS SENSE command is sent.

### ● First byte

Bit No.	Status: If the bit is 1
7	Always 1
6	Always 0
5	Unused : Always 0
4	DMF : Playing back LP-mode tape
3	Unused : Always 0
2	JVC TABLE2 : JVC TABLE 2 enabled
1	JVC TABLE1 : JVC TABLE 1 enabled.
0	LOCAL : REMOTE switch set to LOCAL

### ● Second byte

Bit No.	Status: If the bit is 1
7	TC GENERATOR : Time code generator in the TCG mode.
6	USER BIT : Counter mode set to the UB mode.
5	TIME CODE : Counter mode set to the TC mode.
4	CONTROL PULSE : Counter mode set to the CTL mode.
3	CTL completion : Always 0
2	DROP FRAME : Current time code in the DROP FRAME mode
1	LTC : Always 1
0	Unused : Always 0

### ● Third byte

Bit No.	Status: If the bit is 1
7	TC REC RUN : TCG set to the Rec Run mode
6	TC REGEN : TCG set to the REGENERATION mode
5	TC EXTERNAL : TCG set to the EXT mode
4	TC INSERT LED : Time code insert edit mode
3	AUD1 INSERT LED : Audio-1/2 insert edit mode
2	AUD2 INSERT LED : Audio-3/4 insert edit mode
1	VIDEO INSERT LED : Video insert edit mode
0	ASSEM : Assemble mode

### ● Fourth byte

Bit No.	Status: If the bit is 1
7	TBC PWB IN : Always 1
6	TC PWB IN : Always 1
5	DA3 INSERT LED : Always 0
4	DA4 INSERT LED : Always 0
3	AUTO MODE : Auto editing/Previewing/Reviewing
2	Unused : Always 0
1	Unused : Always 0
0	Unused : Always 0

## ■ Setup (preset) commands

These commands are for setting various types of VCR data. The commands corresponding to the settings can be transmitted.

Table	Command	Description																																
B	E0	TC DATA PRESET : For presetting the time code data. To set, transmit the time data following this command. Specify the time in order of hour, minute, second and frame, using two digits for each. When ENTER (40h) is transmitted before all digits have been transmitted, the time code data are specified by entering digits from the uppermost digit.																																
B	E1	TC UB DATA PRESET : For presetting the user's bit.																																
	E3	IN DATA PRESET : For presetting the edit-in point. Set by transmitting time data following this command. Specify the time in order of hour, minute, second and frame, using two digits for each. If ENTER (40h) is transmitted before all digits have been transmitted, this command is executed with unspecified parts set as "0." If this is a negative value in the CTL mode, set 38h to the digit of 10H.																																
	E4	OUT DATA PRESET : For presetting the edit-out point. For details, refer to IN DATA PRESET (E3h) above.																																
B	E5	EDIT PRESET : For selecting the edit mode. Each bit is defined as shown in the table below. <table border="1" style="margin-left: 20px;"> <tbody> <tr> <td></td> <td>7</td> <td>6</td> <td>5</td> <td>4</td> </tr> <tr> <td rowspan="2">First byte</td> <td>0</td> <td>0</td> <td>1</td> <td>1</td> </tr> <tr> <td>3</td> <td>2</td> <td>1</td> <td>0</td> </tr> <tr> <td rowspan="3">Second byte</td> <td>0</td> <td>INS</td> <td>ASM</td> <td>Video</td> </tr> <tr> <td>0</td> <td>0</td> <td>1</td> <td>1</td> </tr> <tr> <td>3</td> <td>2</td> <td>1</td> <td>0</td> </tr> <tr> <td></td> <td>0</td> <td>TC</td> <td>Aud-1</td> <td>Aud-2</td> </tr> </tbody> </table> <p>• ENTER (40h) is invalid.</p>		7	6	5	4	First byte	0	0	1	1	3	2	1	0	Second byte	0	INS	ASM	Video	0	0	1	1	3	2	1	0		0	TC	Aud-1	Aud-2
	7	6	5	4																														
First byte	0	0	1	1																														
	3	2	1	0																														
Second byte	0	INS	ASM	Video																														
	0	0	1	1																														
	3	2	1	0																														
	0	TC	Aud-1	Aud-2																														
B	E6	PREROLL TIME PRESET : For setting the preroll time. Specify this by transmitting 2-byte data following this command. First byte for ten's place and second byte for one's place.																																

Table	Command	Description										
	E7	<p><b>TIMER MODE SELECT :</b> For selecting the counter mode. Following this command, send 1-byte data corresponding to the counter mode.</p> <table border="1" style="margin-left: 20px;"> <thead> <tr> <th>High</th> <th>Low</th> <th>Counter mode</th> </tr> </thead> <tbody> <tr> <td rowspan="3">3 (Fixed)</td> <td>1</td> <td>TC</td> </tr> <tr> <td>2</td> <td>CTL</td> </tr> <tr> <td>5</td> <td>UB</td> </tr> </tbody> </table>	High	Low	Counter mode	3 (Fixed)	1	TC	2	CTL	5	UB
High	Low	Counter mode										
3 (Fixed)	1	TC										
	2	CTL										
	5	UB										
	8E	<p><b>DATA SELECT :</b> For setting the date. Following this command, send 6-byte numeric data. Specify month, date and year (in this sequence) with two digits for each.</p>										
	8F	<p><b>TIME SELECT :</b> For setting the time. Following this command, send 6-byte numeric data. Specify hour, minute and second (in this sequence) with two digits for each.</p>										

### ■ Menu switch setup command

#### ● ED: MEMORY SW PRESET (B/J1)

This command is for changing the VCR's menu switches. Following this command, transmit the data (3 bytes) corresponding to the menu switch to be changed.

#### Example: Set SYNC SELECT to EXTERNAL.

In the diagram below, the data corresponding to the setting of EXTERNAL show that DATA 0, D2 No. 1 bit and D2 No. 0 bit are, respectively, 01, 0 and 1. Set the command by transmitting data in a way that the corresponding bit values match them.

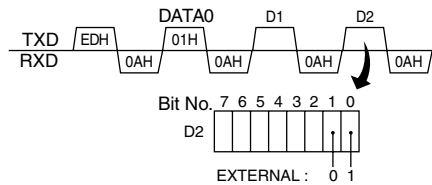

#### ● D3: MEMORY SW SENSE (J1)

This command is for checking the VCR's menu switch setting. Following this command, transmit the data (DATA0) corresponding to the menu switch to be checked.

You can confirm the setting with the bit count of the returned data (D1, D2).

#### Example: Check the SYNC SELECT setting.

As in the diagram below, the setting can be checked by confirming the values for the menu switch. In this example, check the values for DATA0 (namely 01), D2 No. 1 and No. 0 of the returned data.

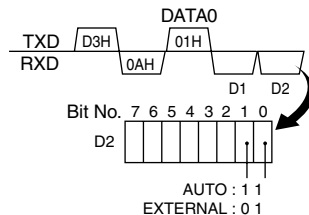

## ■ SYSTEM Menus

Menu	DATA 0	D1/D2	Set value	Corresponding bit values (D1/D2)									
				7	6	5	4	3	2	1	0		
SYNC SELECT	01	D2	AUTO EXTERNAL								1 0	1 1	
"◀, ▶"KEY FUNC.	95	D1	INDEX VAR	0 1									
STL/F.ADV MODE	93	D1	FIELD FRAME									0 1	
	95	D2	1ST 2ND				0 1	1 0					
BACK UP REC TIME	95	D1	OFF						0	0	0		
			25MIN						0	0	1		
			55MIN							0	1	0	
			75MIN							0	1	1	
			115MIN							1	0	0	
			175MIN							1	0	1	
			265MIN							1	1	0	
LONG PAUSE TIME	10	D1	30SEC					0	1	0			
			1MIN					0	1	1			
			2MIN					1	0	0			
			3MIN					1	0	1			
			5MIN					1	1	1			
LONG PAUSE MODE	10	D1	STBY-OFF			0	0						
			F.ADV			1	0						
REPEAT MODE	01	D2	OFF				0	0	0				
			TAPE END				0	0	1				
			INDEX				0	1	0				
			V. END				1	0	0				
DC IN MODE	95	D1	OPE OFF				0	0					
			OPE ON				0	1					
INDEX WRITE	88	D2	OFF				0						
			ON				1						
REPLICATION	95	D1	OFF		0	0							
			SERIAL		0	1							
			DV		1	0							
REPLICATE DELAY	95	D2	OFF						0	0	0		
			1SEC						0	0	1		
			2SEC							0	1	0	
			3SEC							0	1	1	
			4SEC							1	0	0	
			5SEC							1	0	1	
OPERATION LOCK	01	D1	OFF						0				
			ON						1				
PB/DV IN	08	D2	NTSC									0	
			PAL										1

# RS-232C INTERFACE - RS-232C commands - (continued)

## ■ REMOTE Menus

\* With RS-232C, REMOTE SEL 9P and REMOTE SEL 232 cannot be set.

Menu	DATA 0	D1/D2	Set value	Corresponding bit values (D1/D2)									
				7	6	5	4	3	2	1	0		
REMOTE SEL 9-PIN*	93	D2	OFF ON		0 1								
REMOTE SEL 232*	93	D2	OFF ON			0 1							
REMOTE SEL SER	93	D2	OFF ON							0 1			
	96	D1	LOC+REM OFF ON LOC+REM							1 0 0 1			
REMOTE SEL DV	93	D2	OFF ON				0 1						
	96	D1	LOC+REM OFF ON LOC+REM				1 0 0 1						
REMOTE SEL JVC	93	D2	OFF ON	0 1									
REMOTE SEL NET	93	D2	OFF ON					0 1					
	96	D1	LOC+REM OFF ON LOC+REM					1 0 0 1					
LOCAL FUNCTION	20	D1	EJECT STP+EJT ALL KEY NO KEY					0 0 1 1	0 1 0 1				
PREROLL	20	D2	3 SEC 5 SEC 7 SEC 10 SEC					0 0 0 1	0 1 1 0	1 0 1 1	1 1 1 0		
REMOTE FF/REW MODE	93	D1	FF/REW SEARCH	0 1									
REM STOP SEL	93	D1	EE PB			0 1							
PB START DELAY	96	D2	OF 1F					0 0	0 0	0 0	0 0	0 1	
			to 15F					1	1	1	1	1	
SYNCHRONIZATION	40	D1	OFF ON			0 1							
CONTROLLER SEL	90	D2	TYPE1							0	0	0	
			TYPE2							0	0	1	
			TYPE3							0	1	0	
			TYPE4							0	1	1	
FOOT SW	88	D2	OFF		0	0							
			L EDGE		0	1							
			H EDGE		1	0							
			L LEVEL		1	1							

## ■ AUDIO Menus

Menu	DATA 0	D1/D2	Set value	Corresponding bit values (D1/D2)								
				7	6	5	4	3	2	1	0	
AUDIO MODE	03	D2	32k 48k								0 0	0 1
A.OUT AT SEARCH	05	D1	OFF ON				0 1					
AUDIO INPUT SEL	30	D2	XLR RCA								0 1	
AUDIO OUT LEV	30	D1	-20dB -12dB	0 1								
V.FADE	05	D1	OFF ON			0 1						

## ■ VIDEO Menus

VIDEO INPUT SEL	02	D2	Y/C COMPONENT			0 1						
SET UP(NTSC)	02	D2	OFF ON		0 1							
BLACK BURST	0D	D2	OFF ON		0 1							

## ■ TC/UB/CLOCK Menus

TCG SOURCE	81	D2	INTERNAL EXTERNAL							0 1		
TCG SELECT	81	D2	PRESET REGEN					0 1				
TCG MODE	81	D2	FREE RUN REC RUN				0 1					
NDF/DF(NTSC)	81	D2	DROP NON DROP			0 1						
DF BIT(PAL)	78	D2	OFF ON									0 1
TC DUPLICATE	78	D1	OFF AUTO NON DROP	0 0 1	0 1 0							
TC OFFSET	78	D2	OFF +1F +2F -2F -1F				0 0 0 1	0 0 1 0	0 1 1 0			
U-BIT (PAL)	78	D2	OFF ON								0 1	
DATE REC	78	D2	OFF ON			0 1						

# RS-232C INTERFACE

# - RS-232C commands - (continued)

## ■ DISPLAY Menus

Menu	DATA 0	D1/D2	Set value	Corresponding bit values (D1/D2)							
				7	6	5	4	3	2	1	0
LCD BRIGHTNESS	F1	D1	MAX(5) to 0 to MIN(-5)					0	0	0	0
								0	1	0	1
								1	0	1	0
LCD CHROMA	F1	D1	MAX(5) to 0 to MIN(-5)	0	0	0	0				
				0	1	0	1				
				1	0	1	0				
LCD CONTRAST	F1	D2	MAX(5) to 0 to MIN(-5)					0	0	0	0
								0	1	0	1
								1	0	1	0
LCD AUTO OFF	F1	D2	OFF 30MIN 1HOUR 2HOUR		0 0 1 1	0 1 0 1					
DISPLAY	01	D1	OFF					0			
	72	D1	ON					1			
			OFF							0	0
			ON							0	1
			AUTO							1	0
COUNTER POSI.	82	D1	LOWER R	0	0	0	0	0	0	0	0
			LOWER L	0	0	0	0	1	0	0	0
			UPPER R	1	0	1	1	0	0	0	0
			UPPER L	1	0	1	1	1	0	0	0
			CENTER	-	-	-	-	-	-	-	-
TIME CODE	72	D1	OFF						0		
			ON						1		
VTR MODE	72	D1	OFF					0			
			ON					1			
TAPE REMAIN	82	D2	OFF				0				
			ON				1				
TIME/DATE	83	D2	OFF						0	0	0
			TIME						0	0	1
			DATE						0	1	0
			DATE+TM						0	1	1
AUDIO INFO.	72	D1	OFF				0				
			ON				1				
EDIT INFO.	72	D1	OFF			0					
			ON			1					
DATE STYLE	83	D2	YY/MM/DD				0	0			
			MM/DD/YY				0	1			
			DD/MM/YY				1	0			
TIME STYLE	83	D2	12H		0						
			24H		1						



# OTHERS

## - Warning display -

When an error occurs, BR-DV6000 automatically self-diagnoses the cause and displays an error-coded warning message on the monitor.

If BR-DV6000 is not in good order, or if an operation error has occurred, an alarm display will be shown on the monitor or the LCD.

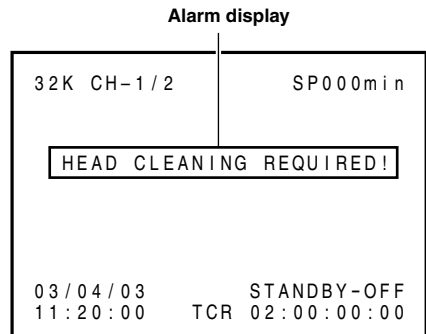
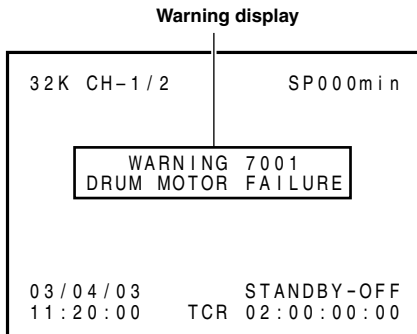

### ■ Alarm display (Displayed regardless of the DISPLAY mode)

Display	Status	Action
<b>LOW VOLTAGE</b>	The DC power voltage is low. BR-DV6000 will eventually go into the OPERATE OFF mode if operation is continued.	Check the power voltage.
<b>HEAD CLEANING REQUIRED!</b>	The video head is dirty. (This message is displayed when the DISPLAY mode is ON or AUTO.) If the head is clogged, it will be detected and the alarm message will be displayed in the PLAYBACK mode. The display disappears when the cassette is ejected or the head gets cleared of clog. The message will also disappear when the head cleaning tape is loaded.	Clean it with a JVC head-cleaning tape. (See Page 8) If the message persists despite cleaning, it could be due to bad recording condition, defective tape or head lifespan.
<b>OVER HEATING!</b>	The internal temperature of BR-DV6000 has exceeded the stated value.	Disconnect the power and place BR-DV6000 in a cool place. If this message is displayed again, the unit may have been damaged. In such a case, consult your JVC authorized dealer.
<b>UNPLUG MAIN POWER, PLUG BACK IN AFTER A WHILE</b>	This is a system error that occurs when the power is turned on. The OPERATE indicator on BR-DV6000 blinks in green. The unit will not accept any operation commands.	Unplug the power cord from the power outlet and wait for some time before plugging it back in.

- For alarm displays resulting from operation errors, Refer to page 24.

# OTHERS

## - Warning display - (continued)

### ■ Warning display (Displayed regardless of the DISPLAY mode)

When a warning display appears, BR-DV6000 stops operation and ceases to accept any operation command. When TAPE DEFECTIVE (5605 - 5609) is displayed, the unit similarly stops all operations except EJECT operation.

Display	Status	Action
WARNING 0201 CONDENSATION ON DRUM	Condensation.	Leave the power on and wait for the display to disappear.
WARNING 3200 LOADING FAILURE	Unable to load tape.	This error can be resolved by turning off and then on the power. However, doing so may damage the tape in some cases. Consult your JVC authorized dealer.
WARNING 3300 UNLOADING FAILURE	Unable to eject tape.	
WARNING 4100 CASSETTE EJECT FAILURE	Eject error.	
DEFECTIVE TAPE! 5605 - 5609	Broken tape.	Press the EJECT button to remove and replace the tape.
WARNING 5702 TAPE END DET. ERROR!	Tape-end sensor error.	This error can be resolved by turning off and then off the power. However, doing so may damage the tape in some cases. Consult your JVC authorized dealer.
WARNING 5802 TAPE BEGIN DET. ERROR!	Tape-beginning sensor error.	
WARNING 7001 DRUM MOTOR FAILURE	Drum rotation error.	
WARNING 7101 CAP MOTOR FAILURE	Capstan rotation error.	
WARNING7202 - 7203 SUPPLY REEL FAILURE	Supply reel rotation error.	
WARNING7302 - 7303 TAKE UP REEL FAILURE	Take up reel rotation error.	
WARNING7305 TAKE UP REEL FAILURE	Tape winding error during unloading.	
WARNING 7401 REEL MOTOR FAILURE	Reel motor rotation error.	

### Memo

This unit uses a microcomputer. It may not function correctly if there is external noise. If this happens, please turn off the power and then on again.

Symptom	Action
<b>No power.</b>	Is the AC adapter correctly connected?
<b>Unable to record.</b>	Is the slide of the cassette tape turned to "REC"? Set it to "REC" if it is at the "SAVE" position.
<b>The operation buttons of BR-DV6000 do not work.</b>	Is OPERATION LOCK of the SYSTEM (2/2) menu set to ON? Set it to OFF if the operation buttons are to be used. For REMOTE, select the buttons that can be operated with the LOCAL FUNCTION Menu.
<b>Editing cannot be controlled even after the REMOTE/LOCAL switch is set to REMOTE.</b>	To control with RS-422A, set REMOTE SEL 9-PIN in the REMOTE (1/2) Menu screen to "ON". To control with the JVC bus, set REMOTE SEL JVC to "ON".
<b>Noise is produced on the playback video. Playback sound interrupted.</b>	<ul style="list-style-type: none"> <li>• The tape is damaged. Replace the tape.</li> <li>• The head is dirty. Clean it with the specified head-cleaning tape. (Page 8)</li> </ul>
<b>Time codes are not correctly recorded during DV signal input.</b>	Is TC DUPLICATE in the TC/UB/CLOCK (1/2) Menu screen correctly set up?
<b>Unable to turn on the power with the OPERATE button.</b>	Isn't the REMOTE/LOCAL switch set to REMOTE when LOCAL FUNCTION in the REMOTE Menu screen is not set to ALL KEYS?
<b>Serial remote control does not function.</b>	Isn't REMOTE SEL SER in the REMOTE (1/2) Menu screen set to OFF? For serial remote control, set it to ON or LOC+REM.
<b>Unable to operate BR-DV6000 with the DV terminal.</b>	Isn't REMOTE SEL DV in the REMOTE (1/2) Menu screen set to OFF? To operate with the DV terminal, set it to ON or LOC+REM.
<b>When the power is turned on, the unit goes into the REC or PLAYBACK mode.</b>	The TIMER switch on the rear panel is set to REC or PLAY. Check the setting of the TIMER switch before turning on the power.

# OTHERS

## - Checking the hour meter -

This unit displays the drum usage time as the hour meter in DRUM HOUR METER in the SYSTEM (2/2) Menu screen. Use it as a guide for regular maintenance. (☞ Page 7)

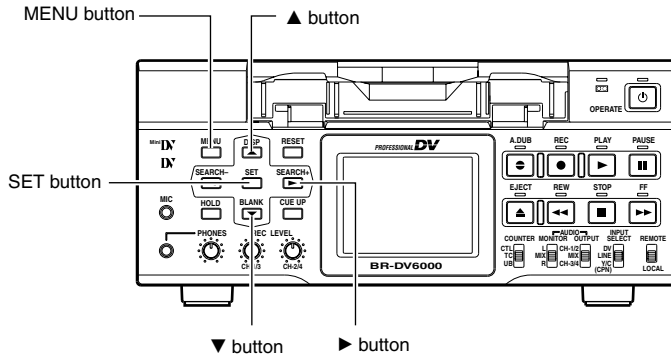

### TOP MENU screen

```

---MENU---
>SYSTEM..
REMOTE..
AUDIO..
VIDEO..
TC/UB/CLOCK..
DISPLAY SET..
NETWORK PACK CONFIG..
MOVIE CLIP..
EXIT
    
```

### SYSTEM (1/2) Menu screen

```

---SYSTEM[1/2]---
SYNC SELECT      AUTO
STL/F.ADV MODE   2ND
BACKUP REC TIME  OFF
LONG PAUSE TIME  5MIN
LONG PAUSE MODE  F.ADV
"<,>" KEY FUNC.  INDEX
REPEAT MODE      OFF
>NEXT PAGE
PAGE BACK
    
```

### SYSTEM (2/2) Menu screen

```

---SYSTEM[2/2]---
>DC IN MODE      OPE OFF
INDEX WRITE      ON
REPLICATION      OFF
REPLICATE DELAY  OFF
OPERATION LOCK   OFF
PB/DV IN        NTSC
FACTORY SETTING  CANCEL
DRUM HOUR METER  000200
PAGE BACK
    
```

Drum usage time

## Operation

### ■ Set BR-DV6000 to the STOP mode:

1. Press the MENU button to display the TOP MENU screen.
2. Press the ▲ or ▼ button to bring the cursor to SYSTEM. Press SET or the ▶ button.
  - The SYSTEM (1/2) Menu screen is displayed.
3. Press the ▲ or ▼ button to bring the cursor to NEXT PAGE. Press SET or the ▶ button.
  - The SYSTEM (2/2) Menu screen is displayed.
  - The drum usage time is displayed on DRUM HOUR METER in the SYSTEM (2/2) Menu screen.
4. Press the MENU button to return to the normal screen.

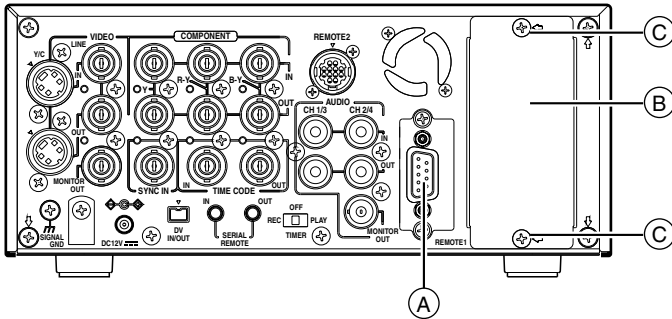

**Memo**

Install an optional board, SA-DV6000, SA-X61U, or SA-X62U to ② as shown in the diagram above.

■ **RS-232C interface board: SA-K46U**

This is an interface board for controlling BR-DV6000 with the RS-232C interface. Connect it to BR-DV6000 with the RS-232C cable. Use a reverse-type cable.

- Replace it with the RS-422A REMOTE (9-PIN) terminal of ①. (☞ Page 102)
- To control BR-DV6000 with RS-232C, set REMOTE SEL 232 in the REMOTE (1/2) Menu screen to "ON".
- Details of the command: (☞ Page 84)

■ **XLR IN board: SA-X61U**

This is an audio input board with two XLR terminals.

- Connect it to ②.
- To enable audio input from the terminals, set AUDIO INPUT SEL in the AUDIO Menu screen to XLR. (☞ Page 78)

■ **XLR OUT board: SA-X62U**

This is an audio output board with two XLR terminals.

- Connect it to ②.

■ **Network board: SA-DV6000**

This network board can be used to record streaming data of video and sound of BR-DV6000 on to CF card, and to transmit streaming data to the PC via a LAN card.

- Connect it to ②.
- To control BR-DV6000 with SA-DV6000, set REMOTE SEL NET in the REMOTE (1/2) Menu screen to ON or LOC+REM.
- With the SA-DV6000 installed, the network-related menus will be added.

For details, refer to the user's guide of SA-DV6000.

**Installing SA-X61U or SA-X62U**

1. Remove the slot cover by removing the two ③ screws, which are securing the cover.
2. Insert SA-X61U or SA-X62U into BR-DV6000.
3. Fix SA-X61U or SA-X62U to BR-DV6000 with the two ③ screws, removed in 1.

**Note**

Contact your JVC authorized service agent before installing the above optional boards.

# OTHERS

## - Installing SA-K46U RS-232C interface board -

The RS-422A REMOTE 1 terminal of BR-DV6000 can be replaced with SA-K46U RS-232C interface board. Use the plate for the RS-422A REMOTE 1 terminal for installing SA-K46U RS-232C interface board.

The replacement procedure is described below. However, to prevent electrical shock or injury, the work should be performed only by a qualified personnel or a JVC authorized service agent.

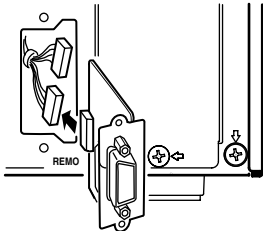
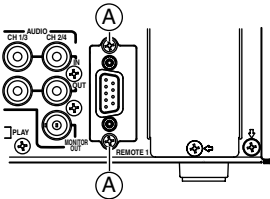

RS-422A REMOTE

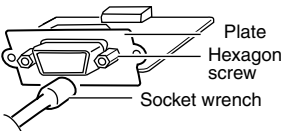

SA-K46U

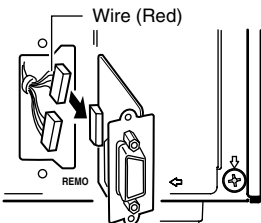
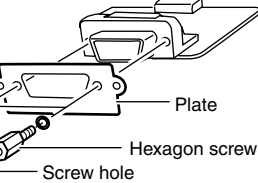

### Caution

To prevent electrical shock, remove the AC adaptor before installing SA-K46U.

### 1. Remove the RS-422A REMOTE 1 terminal.

- ① Remove the two screws **A** and pull out the RS-422A REMOTE 1 terminal.
- ② Remove the connector cable connected to the connector of the RS-422A REMOTE board.  
\*Remove the cable carefully not to damage it.

### 2. Remove the plate of RS-422A REMOTE 1 terminal.

- For removing the plate, remove the two hexagonal screws first with a tool such as a socket wrench.

### 3. Remove the SA-K46U plate in the same procedure above.

### 4. Fix the plate of RS-422A REMOTE 1 terminal, removed in 2 above, to SA-K46U.

### Hexagonal screws

The screw holes for the hexagonal screws are of the inch system.

### 5. Install the SA-K46U.

- ① Connect the connector cable with red wires to the connector of the SA-K46U board.

### Memo

BR-DV6000 connector cable colors  
 RS-232C: Red                      RS-422A: Yellow

- ② Fix SA-K46U to BR-DV6000 with the two screws **A**, removed in **1** - ①.

**■ General**

**Recording system** : DV system (SP mode only)  
**Signal system** : NTSC/PAL (PAL for playback and DV input only)  
**Cassette tape** : Standard/ mini DV cassette tape  
**Tape width** : 6.35mm  
**Tape speed** : 18.812mm/s (NTSC)  
 18.831mm/s (PAL)

**Recording/ playback time**  
 : 276 minutes (LA-DV276)  
 60 minutes (M-DV60)

**Fast forward/ rewind time**  
 : About 3 minutes (LA-DV276)  
 About 1 minute (M-DV60)

**Power** : DC12 V  $\equiv$  (By the supplied AC adapter)

**Power consumption** : 24 W

**External dimension** : 212 mm (W)  $\times$  88mm (H)  $\times$  327mm (D) (Excluding protruding parts)

**Weight** : About 4.0 kg  
 (Not including AC Adapter)

**Allowable operating temperature**  
 : 5°C to 40°C

**Allowable storage temperature**  
 : -20°C to 60°C

**Allowable operating RH**  
 : 30%RH to 80%RH

**■ Video**

**Recording format** : 8 bit, 13.5 MHz,  
 4:1:1 (NTSC)  
 4:2:0 (PAL)

**Video input**

**Line (composite)**  
**Y/C** **Y** : 1.0 V (p-p), 75  $\Omega$  unbalanced  
 : 1.0 V (p-p), 75  $\Omega$  unbalanced  
**C** : 0.286 V (p-p), 75  $\Omega$  unbalanced

**Component** **Y** : 1.0 V (p-p), 75  $\Omega$  unbalanced  
 (100%, Color Bar)  
**R-Y** : 0.7 V (p-p), 75  $\Omega$  unbalanced  
 (75%, Color Bar, Setup 7.5%)  
**B-Y** : 0.7 V (p-p), 75  $\Omega$  unbalanced  
 (75%, Color Bar, Setup 7.5%)

**Video output**

**Line (composite)**  
**Y/C** **Y** : 1.0 V (p-p), 75  $\Omega$  unbalanced  
**C** : 0.286 V (p-p) (NTSC) /  
 0.3 V (p-p) (PAL)  
 75  $\Omega$  unbalance

**Component** **Y** : 1.0 V (p-p), 75  $\Omega$  unbalanced  
 (100%, Color Bar)  
**R-Y** : 0.7 V (p-p), 75  $\Omega$  unbalanced  
 (75%, Color Bar, Setup 7.5%)  
**B-Y** : 0.7 V (p-p), 75  $\Omega$  unbalanced  
 (75%, Color Bar, Setup 7.5%)

**Monitor (composite)** : 1.0 V (p-p), 75  $\Omega$  unbalanced  
 (On-screen display)

**Horizontal resolution** : At least 500 lines

**S/N** : At least 50 dB

**■ Audio**

**Recording format** : 16 bit, 48kHz, 2-channels  
 PCM audio/12 bit, 32kHz,  
 4-channel PCM audio

**Number of track** : 2 (16 bit, 48kHz) /  
 4 (12 bit, 32kHz)

**Audio input** : -8 dBs, 10 k $\Omega$  unbalanced

**Mike input** : -60 dBs, 3 k $\Omega$  unbalanced

**Audio output** : -8 dBs, 1 k $\Omega$  unbalanced

**Headphone** : - $\infty$  to -20 dBs,  
 33 k $\Omega$  unbalanced (stereo)

**Monitor** : -8 dBs, 1 k $\Omega$  unbalanced  
 (monaural)

**Frequency characteristics**

: 20 Hz to 20 kHz (48kHz)

: 20 Hz to 16 kHz (32kHz)

**XLR terminal (Option)**

**Input** : + 4 dBs, high impedance, balanced

**Output** : + 4 dBs, low impedance, balanced

**■ DV interface**

**Input/output** : IEEE1394

**■ Time code**

**LTC input** : 0 $\pm$ 6 dBs, high impedance

**LTC output** : 0 $\pm$ 6 dBs, low impedance

**■ AC adapter**

**Input** : AC 100 V to 120 V $\sim$ ,  
 50 Hz/60 Hz x 1.5 A

**Output** : DC 12 V  $\equiv$  5 A

**■ Accessories**

AC adapter .....  $\times$  1

Power cord .....  $\times$  1

**OTHERS**

**- Specifications - (continued)**

■ External dimensions (Unit: mm)

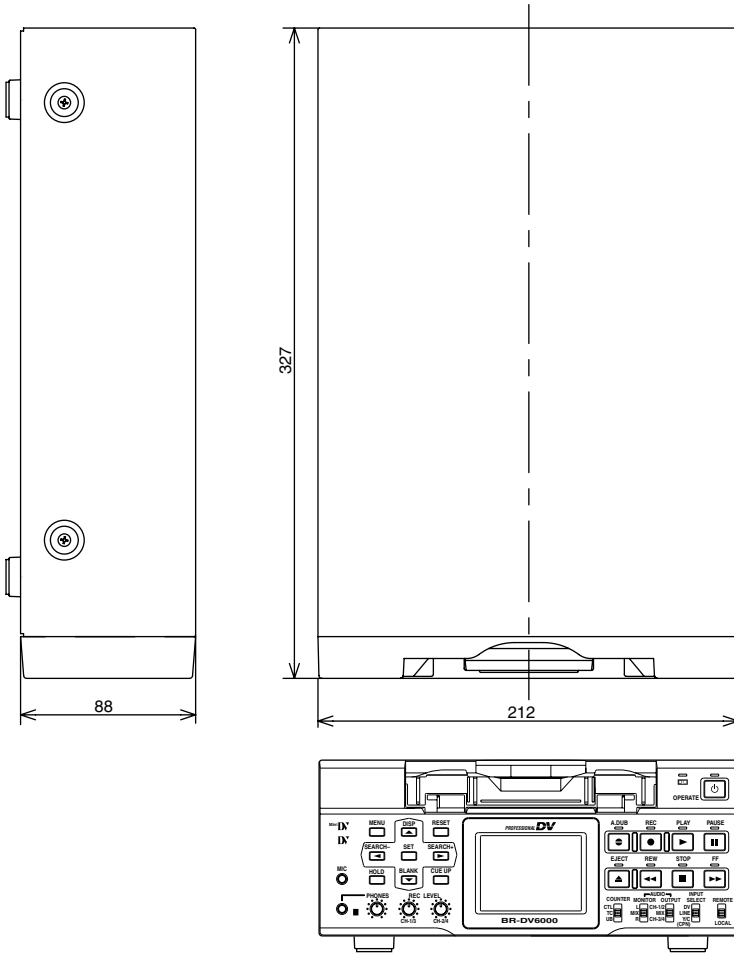

For improvement, the specifications and external appearance may be changed without prior notice.



## ■ AC adapter section

**IMPORTANT SAFETY INSTRUCTIONS**

- 1) Read these instructions.
- 2) Keep these instructions.
- 3) Heed all warnings.
- 4) Follow all instructions.
- 5) Do not use this apparatus near water.
- 6) Clean only with dry cloth.
- 7) Do not block any ventilation openings. Install in accordance with the manufacturer's instructions.
- 8) Do not install near any heat sources such as radiators, heat registers, stoves, or other apparatus (including amplifiers) that produce heat.
- 9) Do not defeat the safety purpose of the polarized or grounding-type plug. A polarized plug has two blades with one wider than the other. A grounding type plug has two blades and a third grounding prong. The wide blade or the third prong are provided for your safety. If the provided plug does not fit into your outlet, consult an electrician for replacement of the obsolete outlet.
- 10) Protect the power cord from being walked on or pinched particularly at plugs, convenience receptacles, and the point where they exit from the apparatus.
- 11) Only use attachments/accessories specified by the manufacturer.
- 12) Use only with the cart, stand, tripod, bracket, or the table specified by the manufacturer, or sold with the apparatus.  
  
When a cart is used, use caution when moving the cart/apparatus combination to avoid injury from tip-over.
- 13) Unplug this apparatus during lightning storms or when unused for long periods of time.
- 14) Refer all servicing to qualified service personnel. Servicing is required when the apparatus has been damaged in any way, such as power-supply cord or plug is damaged, liquid has been spilled or objects have fallen into the apparatus, the apparatus has been exposed to rain or moisture, does not operate normally, or has been dropped.



**WARNING** - To reduce the risk of fire or electric shock, do not expose this apparatus to rain or moisture.

Apparatus shall not be exposed to dripping or splashing and no objects filled with liquids, such as vases, shall be placed on the apparatus.

**CAUTION** – These servicing instructions are for use by qualified service personnel only. To reduce the risk of electric shock, do not perform any servicing other than that contained in the operating instructions unless you are qualified to do so.



**JVC**® is a registered trademark owned by VICTOR COMPANY OF JAPAN, LTD.  
**JVC**® is a registered trademark in Japan, the U.S.A., the U.K. and many other countries.  
© 2003 VICTOR COMPANY OF JAPAN, LIMITED



Printed in Thailand  
LLT0033-001C-H