

JVC Instructions

3-CCD COLOR VIDEO CAMERA **KY-F32**



For Customer Use:

Enter below the Serial No. which is located on the bottom of the body. Retain this information for future reference.

Model No. **KY-F32**

Serial No. _____

| | | |
|--|--|---|
|  | CAUTION RISK OF ELECTRIC SHOCK. DO NOT OPEN |  |
| <p>CAUTION: TO REDUCE THE RISK OF ELECTRIC SHOCK, DO NOT REMOVE COVER (OR BACK). NO USER SERVICEABLE PARTS INSIDE. REFER SERVICING TO QUALIFIED SERVICE PERSONNEL.</p> | | |



The lightning flash with arrowhead symbol, within an equilateral triangle, is intended to alert the user to the presence of uninsulated "dangerous voltage" within the product's enclosure that may be sufficient magnitude to constitute a risk of electric shock to persons.



The exclamation point within a equilateral triangle is intended to alert the user to the presence of important operating and maintenance (servicing) instructions in the literature accompanying the appliance.

POWER SYSTEM

This color video camera should be used with 12 V DC only.

CAUTION:

To prevent electric shocks and fire hazards, do NOT use other than specified power source.

Due to design modification, data given in this instruction book are subject to possible change without prior notice.

WARNING:

TO PREVENT FIRE OR SHOCK HAZARD, DO NOT EXPOSE THIS UNIT TO RAIN OR MOISTURE.

AVERTISSEMENT:

POUR EVITER LES RISQUES D'INCENDIE OU D'ELECTROCUTION, NE PAS EXPOSER L'APPAREIL A L'HUMIDITE OU A LA PLUIE.

Information for USA

This device complies with Part 15 of the FCC Rules. Changes or modifications not approved by the original manufacturer could void the user's authority to operate the equipment.

Information for CANADA

This digital apparatus does not exceed the Class B limits for radio noise emissions from digital apparatus as set out in the interference causing equipment standard entitled "Digital Apparatus", ICES-003 of the Department of Communications.

Renseignement pour CANADA

Cet appareil numérique respecte les limites de bruits radio-électriques applicables aux appareils numériques de Classe B prescrites dans la norme sur le matériel brouilleur; "Appareils Numériques", NMB-003 édictée par le ministre des Communications.

Changes or modifications not approved by JVC could void the user's authority to operate the equipment.

Thank you for purchasing the JVC KY-F32 Color Video Camera.

To make the most of your new camera's many advanced features, please read this booklet carefully.

JVC does not guarantee the contents of a recording if the color video camera, VCR, or video cassette malfunctions during recording.

CONTENTS

| | Page |
|---|------|
| FEATURES | 2 |
| PRECAUTIONS | 3 |
| CONTROLS, CONNECTORS AND INDICATORS | 5 |
| PREPARATIONS | 8 |
| Mounting the lens | 8 |
| Mounting on a tripod stand, fixing unit or pan/tilt unit | 9 |
| CONNECTORS | 11 |
| SETUP | 13 |
| Back focus adjustment | 14 |
| White balance adjustment | 15 |
| Full-time auto white balance | 16 |
| OPERATIONS | 17 |
| GENLOCKING OPERATION | 27 |
| CONNECTORS | 29 |
| TECHNICAL INFORMATION | 30 |
| ALC and EEI operations | 30 |
| Full-time auto white balance | 31 |
| Operation principle of the electronic shutter | 31 |
| High-resolution mode | 32 |
| SPECIFICATIONS | 33 |

FEATURES

- **High-resolution function**
Enhances the vertical resolution.
- **Electronic shutter**
Built-in shutter speeds available are 1/100 (U ver.), 1/120 (E ver.) (flickerless) 1/250, 1/500, 1/1000, 1/2000 and EEI. With the optional remote control unit (RM-LP55), the V. SCAN function is also available.
- **Flickerless mode**
By setting the shutter to 1/100-sec. (U ver.), 1/120-sec. (E ver.) when shooting under a 50 Hz fluorescent lamp, flicker is eliminated.
- **Automatic internal sync/external sync switching**
The KY-F32 incorporates an automatic internal sync/external sync switching system which is especially useful when switching camera images in multi-camera systems or when upgrading the system.
- **Built-in SMPTE type color bars generator (U ver.)**
SMPTE type color bars signal can be generated for easy and precise color adjustment on a monitor.
- **Built-in EBU type color bars generator (E ver.)**
EBU type color bars signal can be generated for easy and precise color adjustment on a monitor.

FEATURES

- **High-performance 3-CCD camera**
Thanks to a newly developed 1/2-inch 380,000 (U ver.), 440,000 (E ver.) pixel CCD with on-chip lens, the KY-F32 delivers a superb, high-quality picture with an S/N ratio of 60 dB and sensitivity as high as 2000 lux at F9.5 (U ver.), F8 (E ver.). High-precision bonding technology and new circuitry incorporated in the CCD assure horizontal resolution of 750 lines.
- **Compact, lightweight camera with bayonet mount**
Weighing a mere 850 grams, the KY-F32's remarkably compact, lightweight design has been made possible by the incorporation of a newly developed IC, 1/2-inch optical system.
- **Comprehensive functions**
 - Automatic functions including ALC, EEI and FAW.
 - 13x and 14x power zoom lenses
YH13X75BKTS (option)
S14X7.5BMD (option)
 - Remote control signal input connector for the optional remote control unit (RM-LP55 or RM-LP57 & RM-713MD)
- **Comprehensive signal outputs**
 - Composite video signal (D-SUB9-pin, BNC)
 - Y/C358 (U ver.), Y/C443 (E ver.) signal (D-SUB9-pin)
 - R/G/B signal (D-SUB9-pin)
 - Component signal (D-SUB9-pin)
 - Composite sync signal (D-SUB9-pin)
- **Negative/positive function**
For special applications such as a negative film shooting
- **Dynamic shading compensation function**
Removes unwanted color effects caused by the attached optical device (either lens or scope).

2

PRECAUTIONS

- **Safety Precautions**
 - To avoid malfunctions, keep flammable objects, water, and metal away from the unit's internal parts and circuitry.
 - Improper connections may result in an unexpected malfunction, abnormal heat or fire.
 - When there is any abnormality (abnormal noise, smell, smoke, etc.) with the unit, immediately turn the power off and contact your nearest JVC-authorized service agent.
 - **CCD Smear and blooming**
Due to the physical structure of the CCDs in this camera it is possible to induce vertical streaking or smear when shooting an extremely bright light source.
Another effect is the expansion of light around a bright light or object called Blooming.
Just as you protect your image against lens flare (internal lens reflections); please be careful when shooting a bright light source.

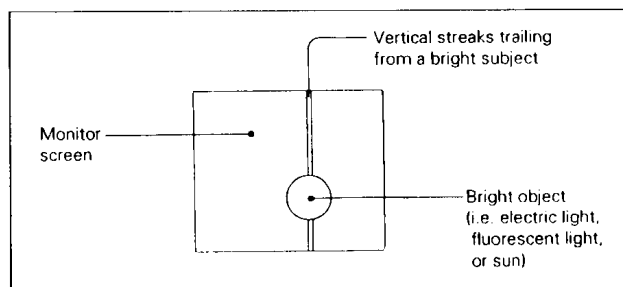

- **Moire or Aliasing**

Shooting stripes, checks, or other alternating patterns may cause jagged or banding in fine mesh patterns.

- **White dots**

White dots may appear on the screen when the camera is operated in a high-temperature environment.

- **Handling Precautions**

- **Do not use or store this camera in places subject to the following:**

- Strong vibrations.
- Exposure to excessive dust.
- Exposure to rain or water.
- Exposure to radioactive rays or X rays.

- **Ambient temperature**

Do not operate the camera outside a -5°C to $+40^{\circ}\text{C}$ (23°F to 104°F) temperature range.

- **Effects of strong electric waves or magnetism**

Strong electromagnetic waves or magnetism (for example, near a radio or TV transmission antenna, transformer or motor) can interfere with the image and generate spurious noise or color.

- **Supply voltage**

Make sure that the power is between 10.5 V and 15 V DC. If the power voltage is too low, abnormal color and increased noise could occur. Do not exceed 15 V DC in any case, or the unit could be damaged.

- **Effect on wireless microphones**

During shooting, this camera may interfere with operation of a wireless microphone and receiver. If used near the camera, the wireless receiver may pick up noise.

- **Cleaning the body**

Wipe body with a dry, soft cloth (such as cheesecloth). When it is extremely dirty, soak the cloth in a solution of neutral detergent, wring it out and then wipe.

To prevent deformation of the body, etc. and to avoid operation hazards, do not allow volatile liquids such as benzene and thinner to touch the body.

If the equipment is soiled with water, oil, solvent, etc., wipe over with soft cloth or cotton first, then clean with gauze, etc. soaked in denatured alcohol.

- **Installation of the camera**

Be sure to set up the camera firmly and correctly.

- **Cleaning the optical system**

Clean the front and external lenses to prevent dust from adhering to them.

CONTROLS, CONNECTORS AND INDICATORS

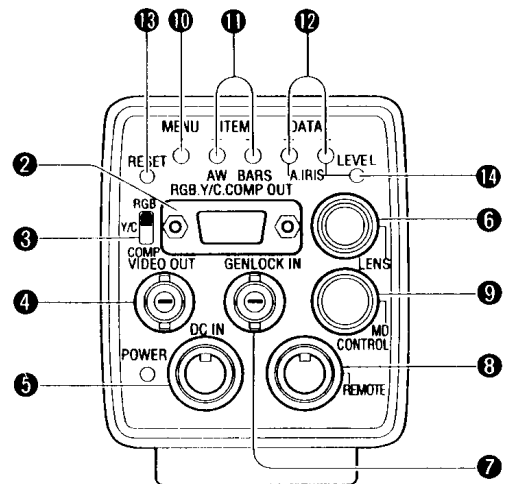
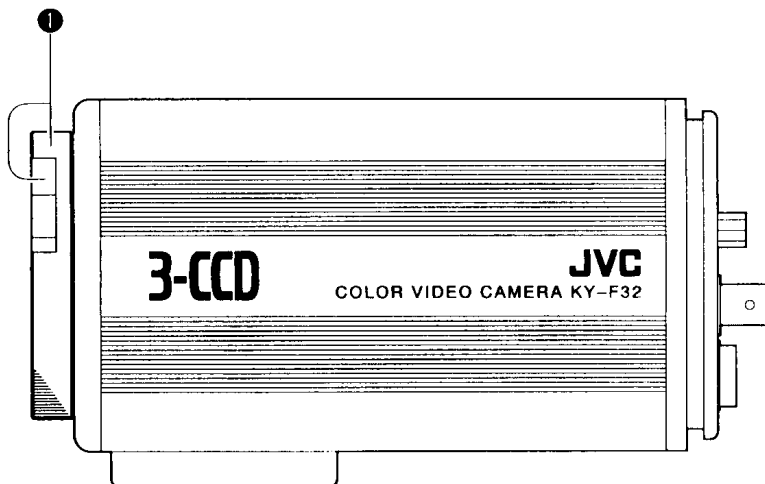

1 Lens mount ring/mount lever

Install the lens and secure it with the mount lever.

2 [RGB, Y/C, COMP OUT] D-SUB terminal

Outputs signals (RGB signals, Y/C358 (U ver.), Y/C443 (E ver.) signals component signals) selected with the 3 select switch and video signals/sync signals.

3 [RGB, Y/C, COMP OUT] select switch

Selects the output signals from the 2 D-SUB terminal.
 RGB: RGB signals are output.
 Y/C : Y/C358 (U ver.), Y/C443 (E ver.) signals are output.
 COMP : Component signals are output.

- 4 [VIDEO OUT] composite video signal output connector**
Outputs composite video signals.
- 5 [POWER, DC IN] power indication LED and DC input connector**
Connect to the AC adapter (optional AA-P700) with the provided cable. When power is supplied, the power indication LED will light.
- 6 [LENS] lens connector**
Connect the lens cable when using the optional power zoom lens.
- 7 [GENLOCK IN] external sync signal input connector**
Accepts an external reference signal to genlock the camera. Input composite video signals or black burst signals.
- 8 [REMOTE] remote connector**
Connect the remote control unit (optional RM-LP55 or RM-LP57).

Note:
When the remote control unit is used, it has priority over the main unit with all duplicated functions.

- 9 [MD CONTROL] MD control connector**
Terminal to control zoom and focus for the motorized zoom lens.

- 10 [MENU] menu button**
Activates or deactivates the MENU screen or changes the menu page.

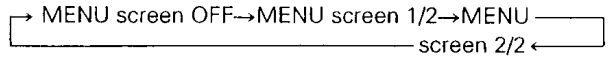

[MENU operation]

- ① Press the MENU button to show MENU1/2 screen.
- ② Move the cursor to the item whose data you want to change with the ITEM (-) and (+) buttons. The item's data will blink.
- ③ Change the data with the DATA (-) and (+) buttons.
- ④ Repeat procedures ② and ③.
- ⑤ When all settings for MENU 1/2 are complete, press the MENU button. The MENU2/2 is shown.
- ⑥ Repeat procedures ② and ③ in the same way.
- ⑦ When all settings for MENU2/2 are complete, press the MENU button. MENU2/2 disappears, indicating that the MENU settings are complete.

(Upper section of the rear panel)

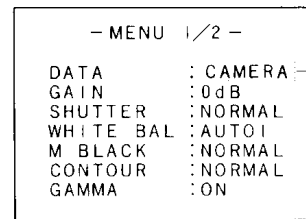
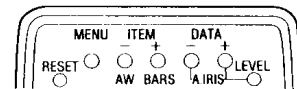

Blinks
Example when DATA is selected

MENU screen 1/2

CONTROLS, CONNECTORS AND INDICATORS

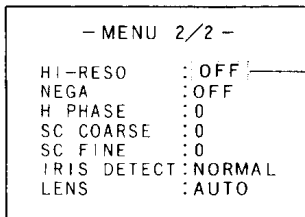

Blinks
Example when HI-RESO is selected

MENU screen 2/2

[When the MENU screen is ON]

11 [ITEM (+), ITEM (-)]

Changes the items on the MENU screen.
With (+), you can choose the lower items.
With (-), you can choose the upper items.

12 [DATA (+), DATA (-)]

Changes the data for the selected item on the MENU screen.

[When the MENU screen is OFF]

⑪ and ⑫ buttons have different functions.

- ITEM (-) button → AUTO WHITE start button
When AUTO1 is selected for WHITE BALANCE, this button activates AUTO WHITE.
- ITEM (+) button → BARS button
This button switches video output signals between BAR and CAM.

- DATA (+), DATA (-) button → AUTO IRIS LEVEL adjustment
This button adjusts the AUTO IRIS level. When the level is off the reference value, the LEVEL LED is lit.

13 [RESET] reset button

When this button is pressed, all data for the MENU items is reset to the reference value.

Reset items and reference values

| Items | Reference values | Items | Reference values |
|-----------|------------------|----------------|------------------|
| DATA | CAMERA | H PHASE | 0 |
| GAIN | 0 dB | SC COARSE | 0 |
| SHUTTER | NORMAL | SC FINE | 0 |
| WHITE BAL | AUTO1 | IRIS DETECT | NORMAL |
| M BLACK | NORMAL | DY-SH MODE | NORMAL |
| CONTOUR | NORMAL | DY-SH(R, G, B) | 0 |
| GAMMA | ON | BARS | OFF |
| HI-RESO | OFF | A IRIS LEVEL | NORMAL |
| NEGA | OFF | | |

14 [LEVEL] auto iris level LED

The LED is lit when the auto iris level is off the reference value.

PREPARATIONS

■ Mounting the lens

The KY-F32 is not provided with a lens.

The power zoom lenses, S14X7.5BMD and YH13X75BKTS, are optionally available.

• When mounting the zoom lens

1. Match the pin (convex section) of the lens with the concave section of the mount. Turn the mount ring to the right until the lens and lens mount are secured.

• When mounting the power zoom lens

1. Match the pin (convex section) of the lens with the concave section of the mount. Turn the mount ring to the right until the lens and lens mount are secured.

2. Connect the lens cable to the LENS connector on the rear panel of the camera head and the MD control cable to the MD CONTROL connector.

Note:

- Secure the lens properly. If not, back focus adjustment may not work or the lens may come off.

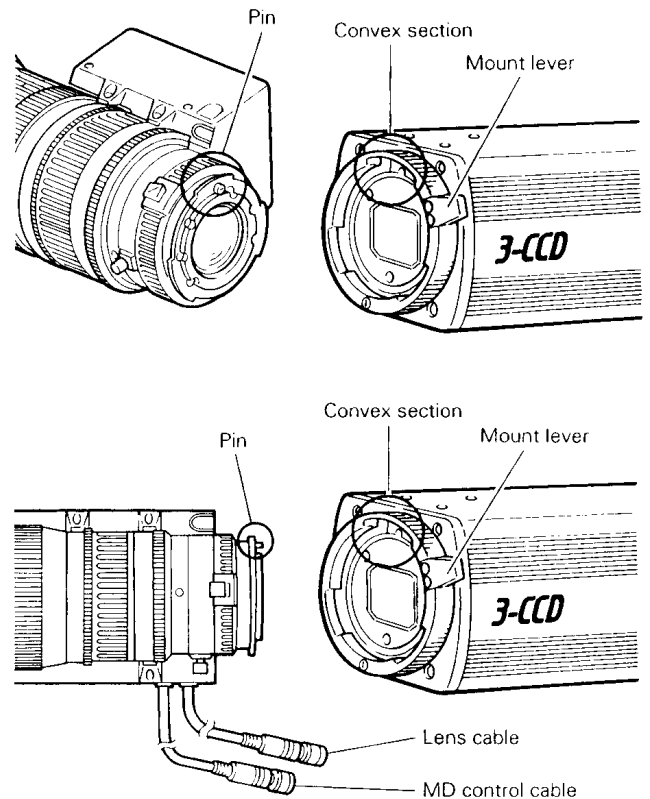

8

PREPARATIONS

■ Mounting on a tripod, stand, fixing unit or pan/tilt unit

[When mounting the bottom of the camera]

1. Install the camera using the camera mounting bracket on a tripod, stand, fixing unit or pan/tilt unit.

[When mounting the top of the camera]

1. Remove the three camera mounting bracket screws on the bottom of the camera.

2. Secure the camera mounting bracket to the top of the camera with the three screws.

3. Install the camera using the camera mounting bracket on the tripod, stand, fixing unit or pan/tilt unit.

■ Trimming the lens cable

If the lens cable and MD control cable are in the way when using the optional power zoom cable, bundle them with the provided cable clamp.

Note:

Tripods, stands, fixing units or pan/tilt units used with this camera should have a rotation stopper and camera mounting screw. If a rotation stopper is not provided, the secured section may loosen and the camera may come off.

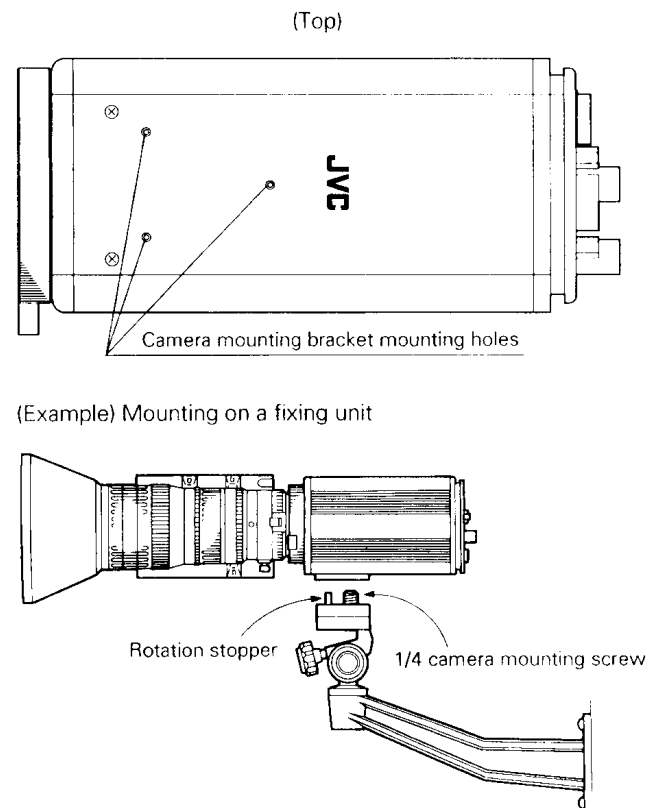

9

- When the camera mounting bracket is secured on the bottom

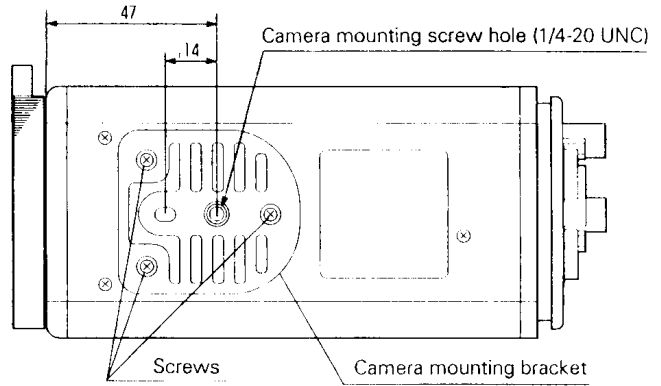
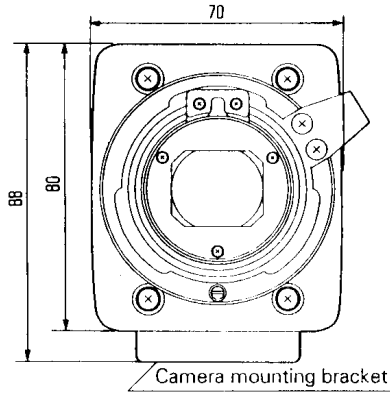

- When the camera mounting bracket is secured on the top

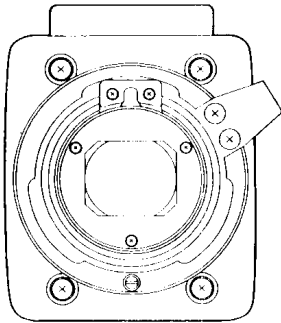

Notes:

- When mounting this camera on a wall or ceiling with a fixing unit or pan/tilt unit, special precautions should be taken for security. You should ask a qualified service person to perform the installation.
- For installation, consult your JVC dealer or JVC service center. JVC is not responsible for damage to the camera caused by falling, dropping, etc., as a result of improper installation.

CONNECTIONS

- Before connection, make sure that the power of all equipment is turned off.

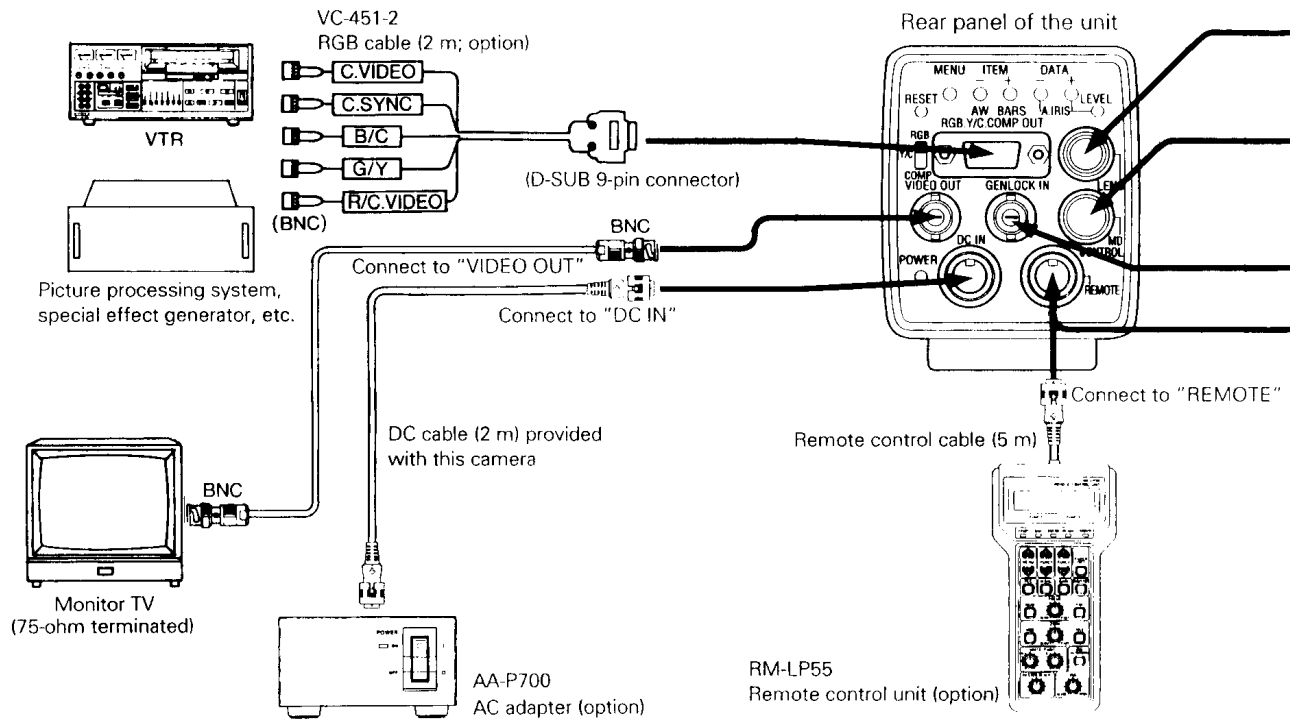

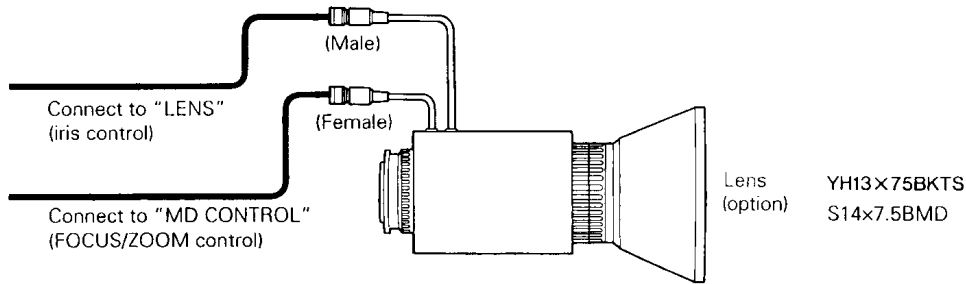

Connect to "GENLOCK" Sync signal (composite video signal or black burst signal)
For details on genlocking connections, refer to "GENLOCKIN OPERATION" on page 28.

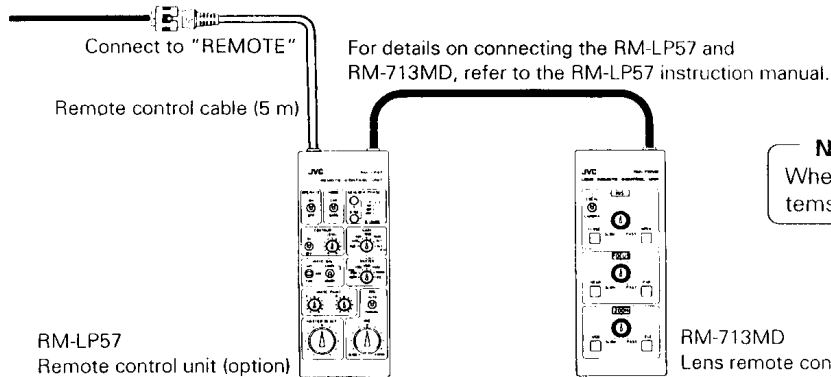

Note:

When the coaxial cables are connected, terminate all systems including unused 75 ohm systems.

SETUP

To ensure clearer pictures and correct color tones, perform the back focus and white balance adjustments.

- Once the back focus adjustment has been performed during lens adjustment, no further adjustments are required.
- White balance must always be adjusted prior to shooting.

1. Prior to adjustment, make sure all necessary equipment (such as a monitor) has been connected. Refer to "CONNECTIONS" on page 12. Then set the camera's switches as shown below.
2. Connect the power plug of the AC adapter (optional AA-P700) to an AC outlet and set the power switch to "ON". The camera's POWER OFF will light up.

Note:

An overcurrent detecting circuit is provided with this camera to protect the electric circuits. Therefore, when the power supply voltage fluctuates or the power of the AC adapter is switched ON and OFF repeatedly, the power may not be supplied correctly to the camera. However, this is not a malfunction.

To restore the power, first switch the power of the AC adapter to OFF, wait for several seconds, then switch the power ON again.

3. Aim the camera at an appropriate subject, operate the lens focus and zoom, and confirm that the picture is shown on the monitor.

■ Back focus adjustment

As the power zoom lens does not have a Manual mode, be sure to connect the RM-LP55 or RM-LP57+RM-713MD (remote control unit).

For details, refer to the instruction manual provided with the lens.

This adjustment should be performed while referring to the monitor.

- Prior to adjustment, check that the macro ring is in the original position.

1. Set the iris ring to "1.4" (open) with the connected remote control unit. In this case, if the illumination is too bright, decrease the illuminance or perform this operation in a dark place.

Loosen the zoom ring fixing knob.

2. Turn the zoom ring to the maximum telephoto position (TELE) with the remote control unit.
3. Adjust the focus by turning the focus ring with the remote control unit.
4. Turn the zoom ring to the maximum wide angle position (WIDE) with the remote control unit.
5. Loosen the back focus fixing knob.
6. Turn the back focus adjustment ring until optimum focus is obtained.
7. Repeat steps 2 to 6 two or three times.

8. Secure the back focus fixing knob.

(Example)

When using the S14X7.5BMD

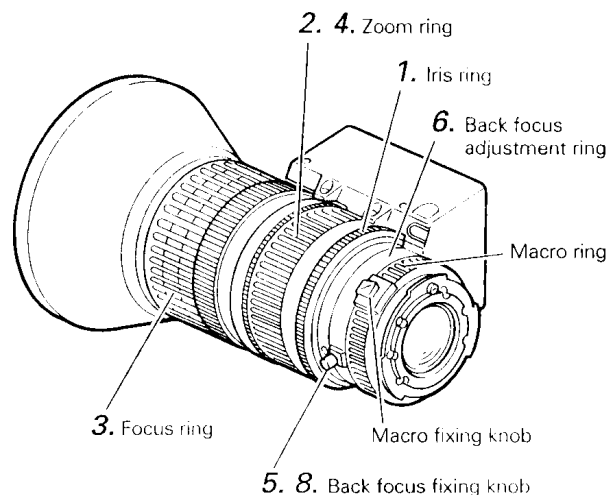

Note:

When performing the back focus adjustment, set the camera at a distance of no more than 3 meters from the subject (pattern) to assure optimal adjustment.

14

SETUP

■ White balance adjustment

- If the color temperature of the light source changes during shooting, white balance adjustment is required.

1. Check that WHITE BAL is set to "AUTO" on the MENU screen. If it is set to any other mode, set to "AUTO" using the MENU.

(Refer to [4] WHITE BAL on page 19.)

2. Shoot a white object (white paper, white wall, etc.) or gray scale chart in full screen using the remote control.

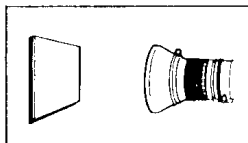

3. Press the auto white start button (AW). The start message will be displayed.

Note:

When the white paint is set with the remote control unit, white paint data is set to OFF.

◆ Start message

AUTO WHITE1
OPERATION

AUTO WHITE2
OPERATION

Auto white start button

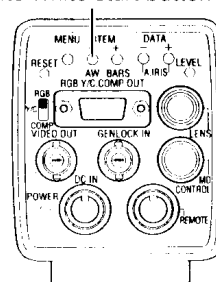

4. When auto white adjustment is complete, one of the following messages is shown.

◆ Normal adjustment completion message

| | |
|--------------------------|--------------------------|
| AUTO WHITE1 COMPLETED | AUTO WHITE2 COMPLETED |
|--------------------------|--------------------------|

◆ Abnormal adjustment completion message (1)

| | |
|--------------------------------|--------------------------------|
| AUTO WHITE1 LOW LIGHT ERROR | AUTO WHITE2 LOW LIGHT ERROR |
|--------------------------------|--------------------------------|

◆ Abnormal adjustment completion message (2)

| | |
|---------------------------------|---------------------------------|
| AUTO WHITE1 OVER LIGHT ERROR | AUTO WHITE2 OVER LIGHT ERROR |
|---------------------------------|---------------------------------|

◆ Abnormal adjustment completion message (3)

| | |
|-----------------------------|-----------------------------|
| AUTO WHITE1 OBJECT ERROR | AUTO WHITE2 OBJECT ERROR |
|-----------------------------|-----------------------------|

Note:

This camera only has the AUTO1 mode. However, when WHITE BAL is activated with the RM-LP55/LP57, 2 modes (AUTO1/AUTO2) are available.

15

Notes:

- OBJECT ERROR
The OBJECT is color.
 Shoot a white OBJECT.
The color temperature is out of the adjustment range (2500K to 8000K).
 Insert the color temperature conversion filter in front of the lens.
- LOW LIGHT ERROR, OVER LIGHT ERROR
The illuminance of the OBJECT is too low or high.
 Adjust the illumination.

■ **Full-time auto white balance (automatic color temperature maintenance)**

- The full-time auto white balance automatically adjusts white balance even if lighting conditions change to maintain optimum balance at all times.
 Refer to "Full-time auto white balance" on page 31.
1. Set the WHITE BAL on the MENU1/2 to "FAW".
 (Refer to [4] "WHITE BAL" on page 19.)

Note:

If the overall screen has a mono color tone or a vividly colored object is shot, optimum balance adjustment is not possible. This is a phenomenon caused by the operation principle and not a malfunction. In this case, adjust white balance again following "White balance adjustment" on page 15.

OPERATIONS (MENU operation)

The following menus are available for this camera.

- Menu
- Dynamic shading compensation (see page 23)
- STATUS check menu (see page 24)

[MENU operation method]

- ① Pressing the MENU button outputs the MENU 1/2 screen.
- ② Move the cursor to the data to be changed with the ITEM (-) and (+) buttons. The selected data will blink.
- ③ Change the data with the DATA (-) and (+) buttons.
- ④ Repeat steps (2) and (3).
- ⑤ When the all settings on MENU 1/2 are complete, press the MENU button to display the MENU 2/2 screen.
- ⑥ Repeat steps (2) and (3).
- ⑦ When the all settings on MENU 2/2 are complete, press the MENU button. MENU 2/2 disappears, indicating that MENU setting is complete.

[1]DATA

- To maintain the conditions set up with the RM-LP55.
- ① Select the "DATA" with the ITEM (-) and (+) buttons so that the data blinks.
 - ② Change the data with the DATA (-) and (+) buttons.

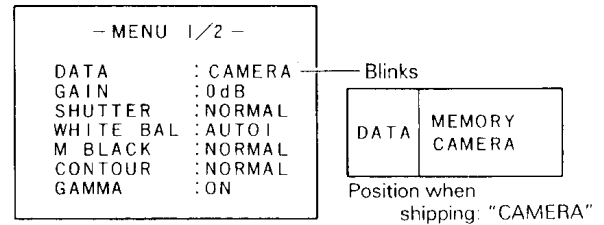

MENU 1/2 screen

CAMERA: Normal use. This setting is used when the camera is used by itself.

MEMORY: This setting is used when the remote control data is stored in the camera with the RM-LP55. (For details, refer to the RM-LP55's instruction manual.)

Even if the RM-LP55 is disconnected and the power switch is turned ON and OFF, data set by the RM-LP55 is retained.

Note:

When the RM-LP57 is connected, the camera cannot be used in the MEMORY mode. Be sure to use the camera in the CAMERA mode.

[2]GAIN

- To increase the sensitivity electronically
- ① Select the "GAIN" with the ITEM (-) and (+) buttons so that the data blinks.
- ② Change the data with the DATA (-) and (+) buttons.

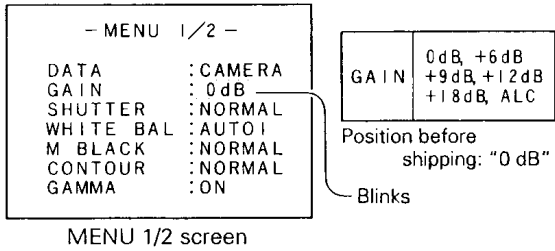

When a object is too dark and sufficient light cannot be obtained, the sensitivity of the camera can be increased electronically.

The increased amount of the sensitivity

- 0 dB : Standard
- +6 dB : Double
- +9 dB : 2.8 times
- +12 dB : 4 times
- +18 dB : 8 times

- The higher the sensitivity, the coarser the picture.
 - The ALC sets automatically the camera sensitivity according to the brightness of the object.
- See "ALC and EEI operations" on page 30.

[3]SHUTTER

- Setting the Shutter mode
- ① Select "SHUTTER" with the ITEM (-) and (+) buttons so that the data blinks.
- ② Change the data with the DATA (-) and (+) buttons.

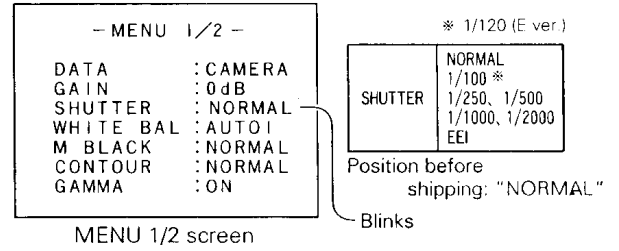

- Useful when shooting a fast-moving object.
 - In the NORMAL mode, the shutter speed is 1/60 sec. (U ver.), 1/50 sec. (E ver.)
 - The shutter speed can be selected from 1/100 (U ver.), 1/120 (E ver.), 1/250, 1/500, 1/1000, 1/2000 and EEI.
 - EEI function lets the electronic shutter automatically set the level when operating under very bright illumination.
- See "ALC and EEI operation" on page 30.

Note:

Use the EEI mode outdoors. When the EEI mode is used under a fluorescent lamp, the image may flicker.

OPERATIONS (MENU operation)

[4]WHITE BAL

- White balance adjustment
- ① Select "WHITE BAL" with the ITEM (-) and (+) buttons so that the data blinks.
- ② Change the data with the DATA (-) and (+) buttons.

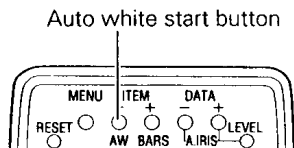
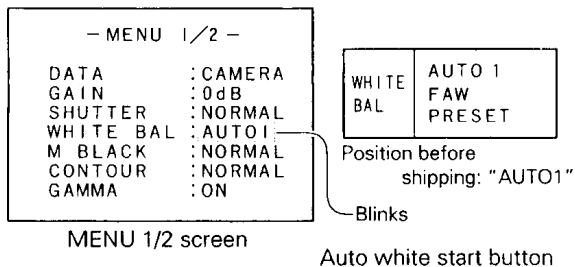

AUTO1 : Activates white balance set with the automatic adjustment function. Engage this mode with the ITEM (-)/AW button.

PRESET : Activates white balance set under illumination with the color temperature of 3200K.

FAW : Automatic color temperature maintenance white balance.
See "Full-time auto white balance" on page 31.

[5]M BLACK

- Setting the master black level
- ① Select the "M BLACK" with the ITEM (-) and (+) button so that the data blinks.
- ② Change the data with the DATA (-) and (+) buttons.

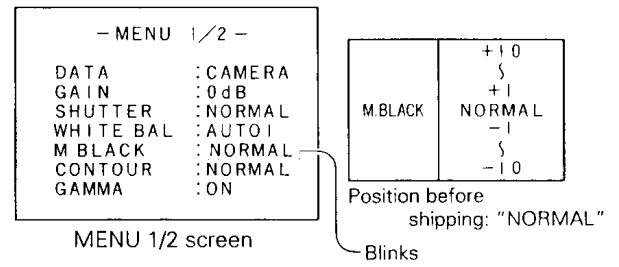

- The reference black level (master black) can be set.
- +10 : Highest black level condition
- 10 : Lowest black level condition

[6] CONTOUR

- Contour compensation adjustment
- Select "CONTOUR" with the ITEM (-) and (+) buttons so that the data blinks.
 - Change the data with the DATA (-) and (+) buttons.

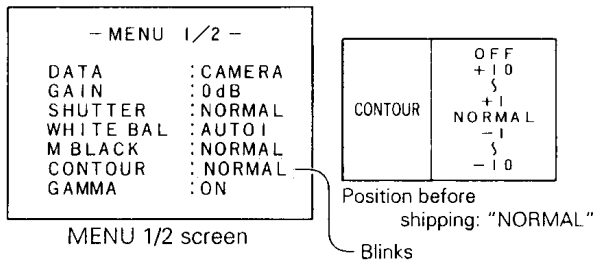

- Contour compensation function electronically emphasizes the edges of a video signal to obtain a sharper picture.
 - +10 : Much
 - NORMAL : Standard
 - 10 : A little
 - OFF : No compensation

[7] GAMMA

[7] GAMMA

- Setting the gamma compensation
- Select "GAMMA" with the ITEM (-) and (+) buttons so that the data blinks.
 - Change the data with the DATA (-) and (+) buttons.

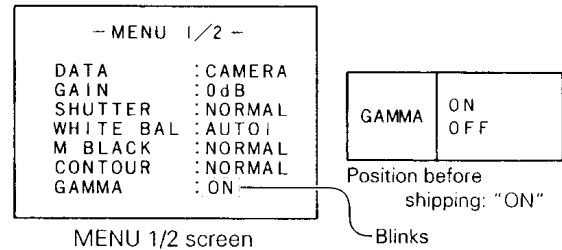

- The gamma compensation is set to ON and OFF.
 - ON : Gamma compensation applied (gamma ratio of 0.45)
 - OFF : No gamma compensation applied (gamma ratio of 1)

20

OPERATIONS (MENU operation)

[8] HI-RESO

- Setting the High-resolution mode
- Select the "HI-RESO" with the ITEM (-) and (+) buttons so that the data blinks.
 - Change the data with the DATA (-) and (+) buttons.

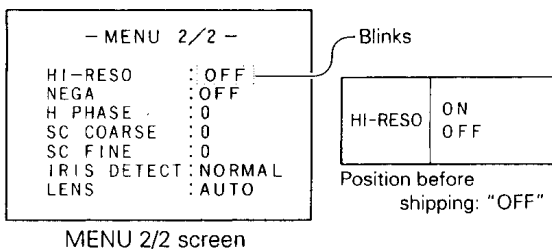

- The HI-RESO mode enhances the resolution in the vertical direction and should be used when shooting a still picture or when using this camera as a microscope. (Storage time is 1/30 sec. (U ver.), 1/25 sec. (E ver.))
 - ON : The HI-RESO mode is engaged. See "HI-RESO mode" on page 32.
 - OFF : The Normal Shooting mode is engaged.

Note:

When a moving object is shot in the HI-RESO ON mode, the after-image lag phenomenon is greater than in the OFF mode.

[9] NEGA

- Setting negative video
- Select "NEGA" with the ITEM (-) and (+) buttons so that the data blinks.
 - Change the data with the DATA (-) and (+) buttons.

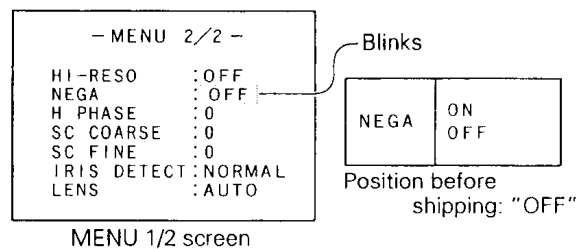

- Use when taking a positive film from a negative film.
 - ON : The camera video signals are reversed (negative) for output.
 - OFF : The camera video signals are output.

[10] H PHASE

[11] SC COARSE

[12] SC FINE

Refer to "GENLOCKING OPERATION" on page 27.

[13] IRIS DETECT

- Setting the Iris Detection mode
- ① Select "IRIS DETECT" with the ITEM (-) and (+) buttons so that the data blinks.
 - ② Change the data with the DATA (-) and (+) buttons.

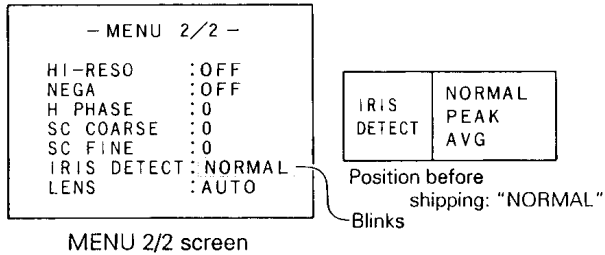

- Use to change the iris setting according to the subject. (The selected IRIS DETECT mode is activated only when the LENS mode is set to "AUTO".
- NORMAL : Standard setting
PEAK : The iris is set for the peak of the video level.

Use this mode when shooting a object lit by a spot light.

AVG : The iris is set to the average value of the video level.

Use this mode to obtain a brighter shot of a backlit object.

[14] LENS

- Setting the LENS mode
- ① Select "LENS" with the ITEM (-) and (+) buttons so that the data blinks.
 - ② Change the data with the DATA (-) and (+) buttons.

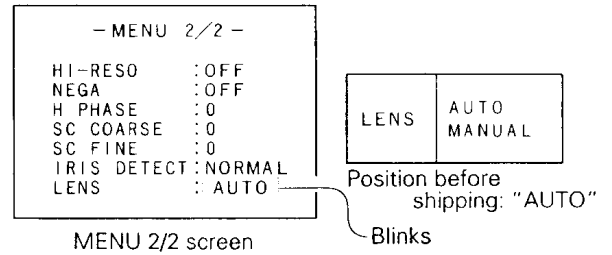

- Use to set the IRIS mode of the lens.
- AUTO : Set to this mode when the auto iris lens is used.
MANUAL : Set to this mode when the manual iris lens is used.

Note:

When the lens is set to MANUAL, it will not function as an auto iris lens even if the IRIS mode has been set to "AUTO" with the RM-LP55/LP57. In this case, set the camera to AUTO on the camera itself.

OPERATIONS (MENU operation)

■ DY-SH ADJ

- Dynamic shading adjustment

Shoot a white object (white paper, white wall, etc.) in full screen and adjust the R/G/B data so that the coloring in the upper and lower parts of the monitor screen is minimized.

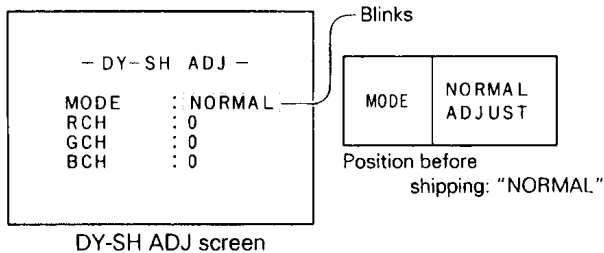

- ① While holding the MENU button pressed, press the ITEM (-) button. Then, release the MENU button.
- ② Set the mode to "ADJUST" with the DATA (-) and (+) buttons.
- ③ Move the cursor to the data to be changed. The selected data will blink.

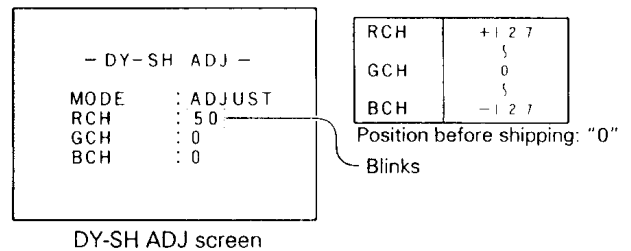

- ④ Change the data with the DATA (+) and (-) buttons.
- ⑤ Repeat steps ③ and ④.
- ⑥ When the settings for DY-SH ADJ are complete, press the MENU button. The DY-SH ADJ screen goes out.

Note:

Note that if you press the MENU button while holding the ITEM (-) button pressed, the AUTO WHITE MODE is engaged.

■ STATUS check operation

Two STATUS screens are available. These screens allow you to check the conditions set on the camera's MENU screen or the settings stored in memory using the local remote control (RM-LP55).

- ① While holding the MENU button pressed, press the ITEM (+) button. Then, release the MENU button. The status 1/2 screen will appear.
- ② When the DATA on the MENU 1/2 screen is set to "CAMERA", the setting conditions set on the MENU screen are shown. When it is set to "MEMORY", settings stored in memory using the remote control unit (RM-LP55) are shown.
- ③ Press the MENU button to show the STATUS 2/2 screen.
- ④ Press the MENU button to end the STATUS screen.

Note:

When the DATA is set to CAMERA on the STATUS 1/2 screen (without using the RM-LP55) pressing and holding the ITEM (+) button causes color bars and camera pictures to alternate on the screen. In this condition, press the MENU button.

| | |
|----------------|---------------|
| - STATUS 1/2 - | |
| DATA | : REMOTE |
| GAIN | : 0dB |
| SHUTTER | : NORMAL |
| WHITE BAL | : AUTO1 |
| | <RCH:0 BCH:0> |
| M BLACK | : NORMAL |
| CONTOUR | : NORMAL |
| GAMMA | : ON |

STATUS 1/2 screen

| | |
|----------------|----------|
| - STATUS 2/2 - | |
| HI-RESO | : OFF |
| NEGA | : OFF |
| H PHASE | : 0 |
| SC COARSE | : 0 |
| SC FINE | : 0 |
| IRIS DETECT | : NORMAL |
| IRIS LEVEL | : NORMAL |

STATUS 2/2 screen

Note:

H PHASE, SC COARSE and SC FINE are displayed only while genlocking is performed.

OPERATIONS (MENU operation)

■ Setting the camera type

Note:

- When the V. SCAN function is activated with the RM-LP55, you must set the CAMERA TYPE with the RM-LP55 because the shutter speed indication value is different depending on the camera connected.
- Even if the setting is not different, operation with the RM-LP55 is possible. To show the correct value, perform the following setting with the RM-LP55.

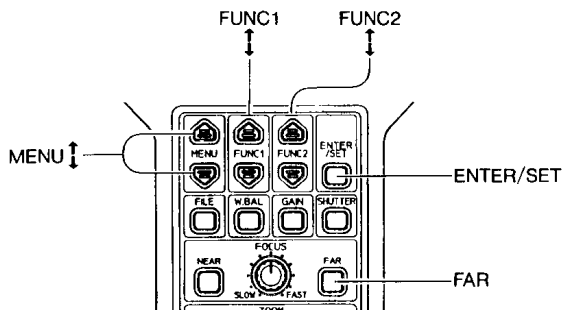

Operation procedures

- ① On the RM-LP55, while keeping the "ENTER/SET" button and "FAR" button pressed, press the OPERATE button to ON.

The following indication is shown in the LCD panel.



- ② Show the CAMERA TYPE setting screen with the MENU and MENU buttons.

The following indication is shown in the LCD panel.

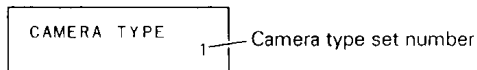

- ③ Set the camera type set number to 3 with the FUNC2 and FUNC2 buttons.
- ④ Press the ENTER/SET button. The INITIALIZE will be shown and the NORMAL mode is set.

Note:

Once this setting is performed, resetting is not required unless a different camera is used.

■ Remote control unit (option) function table

| Functions | Operations on this camera | Operations with the RM-LP55 |
|---------------------------|---|--|
| MODE | ○ BARS/CAM | ○ BARS/CAM/NEGA |
| NEGA | ○ ON/OFF | ○ BARS/CAM/NEGA |
| CONTOUR | ○ ON (LEVEL)/OFF | ○ ON (LEVEL)/OFF |
| GAMMA | ○ ON/OFF | ○ ON/OFF |
| MASTER BLACK LEVEL | ○ | ○ |
| AI LEVEL | ○ | ○ |
| IRIS DETECT | ○ NORMAL/PEAK/AVG | ○ NORMAL/PEAK/AVG |
| WHITE BALANCE | ○ AUTO/FAW/PRESET | ○ PRESET/MANUAL/AUTO1/AUTO2/FAW |
| WHITE PAINT | × | ○ AUTO1/AUTO2 |
| GAIN | ○ 0 dB/+6 dB/+9 dB/+12 dB/+18 dB/ALC | ○ 0 dB/+6 dB/+9 dB/+12 dB/+18 dB/ALC/ALC + EEI |
| SHUTTER | ○ NORMAL, 1/100 (U ver.), 1/120 (E ver.), 1/250, 1/500, 1/1000, 1/2000, EEI | ○ NORMAL, 1/100 (U ver.), 1/120 (E ver.), 1/250, 1/500, 1/1000, 1/2000, V. SCAN, EEI |
| TITLE INDICATION | × | ○ ON/OFF |
| TITLE INDICATION POSITION | × | ○ |
| TITLE SETTING | × | ○ |
| DATA | ○ MEMORY/CAMERA | × |
| FILE | × | ○ FILE (READ, SAVE, RM DATA TO CAM) |
| D-SUB OUT | ○ Y/C, RGB, COMPONENT | × |
| H. PHASE | ○ | ○ |
| SC COARSE | ○ 0°/90°/180°/270° | ○ 0°/90°/180°/270° |
| SC FINE | ○ | ○ |
| RANDOM TRIGGER | × | ○ OFF/ON (1/50, 1/120, 1/250, 1/500, 1/1000, 1/2000, 1/4000, 1/10000) |
| SYNC RESET | △ RESET/NON-RESET (DIP SW) | × |
| HI-RESO | ○ ON/OFF | ○ ON/OFF |
| DYNAMIC SHADING | ○ ADJUST/NORMAL | × |

○ : This function available.

× : This function is not available.

△ : Modify

26

GENLOCKING OPERATION

When pictures from more than one camera are to be processed (fade in, fade out, and mix wipe) with a special effects generator (SEG), genlocking is used to synchronize the various camera pictures.

- The sync phase adjustment can be performed with the remote control unit (optional RM-LP55 or optional RM-LP57) as well.

[10] H. PHASE

- Adjustment of the horizontal sync phase
- Select the "H PHASE" with the ITEM (-) and (+) buttons so that the data blinks.
 - Change the data with the DATA (-) and (+).

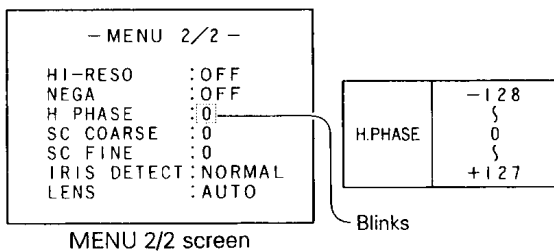

[11] SC COARSE

- Adjustment of the color sync phase
- Perform coarse adjustment with the color sync phase coarse adjustment. (0°/90°/180°/270°)
- Select "SC COARSE" with the ITEM (-) and (+) buttons so that the data blinks.
 - Change the data with the DATA (-) and (+).

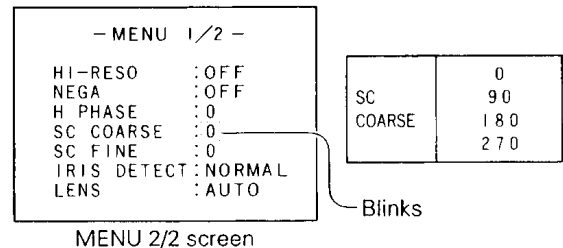

[12] Adjustment of the SC FINE

- Fine adjustment is performed by changing the color sync phase fine adjustment data.
- ① Select "SC FINE" with the ITEM (-) and (+) buttons so that the data blinks.
- ② Change the data with the DATA (-) and (+).

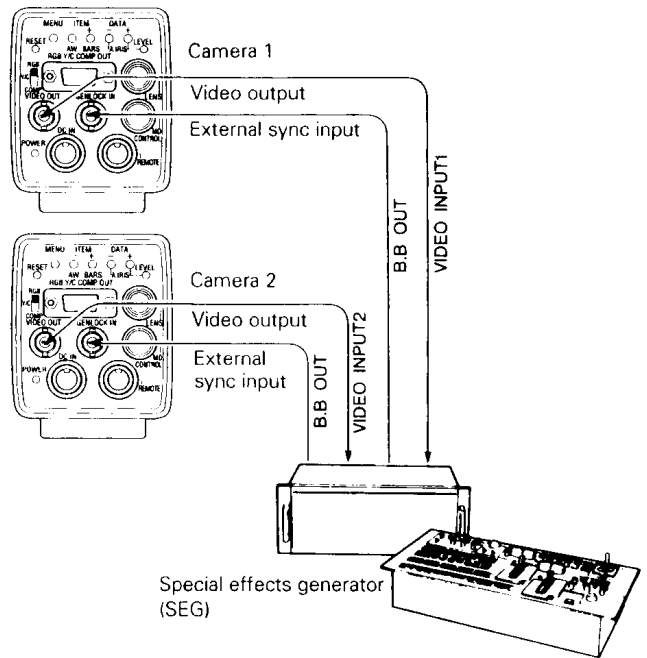
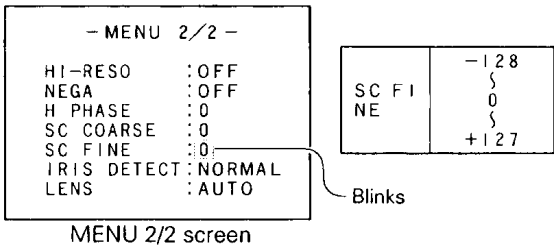

- Notes:**
- If a vector scope and a waveform monitor are available, these adjustments can be performed accurately.
 - A VCR playback signal cannot be used as a sync signal. Be sure to use a TBC (time base corrector) such as a frame synchronizer.
 - Be sure to use an underscan monitor as a monitor.

CONNECTORS

■ D-SUB connector

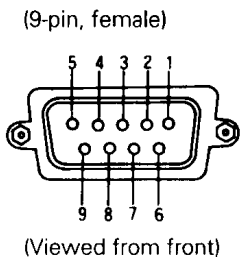

| Pin No. | Signal (RGB signal selected) | Signal (Y/C signal selected) | Signal (component selected) |
|---------|-------------------------------|-------------------------------|-------------------------------|
| ① | Ground | Ground | Ground |
| ② | Ground | Ground | Ground |
| ③ | R (RED) signal output | Composite video signal output | R-Y signal output |
| ④ | G (GREEN) signal output | Y signal output | Y signal output |
| ⑤ | B (BLUE) signal output | C signal output | B-Y signal output |
| ⑥ | Composite video signal output | Composite video signal output | Composite video signal output |
| ⑦ | Composite sync signal output | Composite sync signal output | Composite sync signal output |
| ⑧ | Ground | Ground | Ground |
| ⑨ | Ground | Ground | Ground |

■ Lens connector

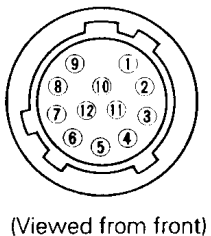

| Pin No. | Signal |
|---------|--------------|
| ① | NC |
| ② | NC |
| ③ | Ground |
| ④ | NC |
| ⑤ | IRIS control |
| ⑥ | +12 V |
| ⑦ | — (NC) |
| ⑧ | IRIS A/R |
| ⑨ | NC |
| ⑩ | NC |
| ⑪ | NC |
| ⑫ | NC |

■ Remote connector

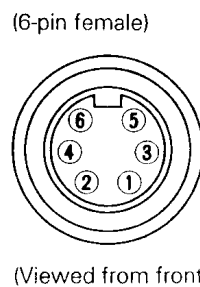

| Pin No. | Signal |
|---------|-------------|
| ① | Ground |
| ② | OPERATE |
| ③ | Ground |
| ④ | SID2 |
| ⑤ | SID1 |
| ⑥ | +9 V output |

DC input

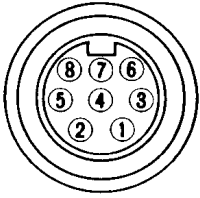

| Pin No. | Signal |
|---------|-------------|
| ① | — |
| ② | Ground |
| ③ | — |
| ④ | — |
| ⑤ | Ground |
| ⑥ | +12 V input |
| ⑦ | — |
| ⑧ | +12 V input |

MD control

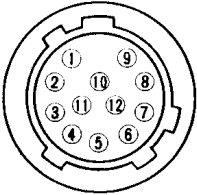

| Pin No. | Signal |
|---------|-------------------|
| ① | FOCUS CONT SELECT |
| ② | ZOOM CONT SELECT |
| ③ | Ground |
| ④ | NC |
| ⑤ | NC |
| ⑥ | +12 V |
| ⑦ | — |
| ⑧ | FOCUS CONTROL |
| ⑨ | ZOOM CONTROL |
| ⑩ | NC |
| ⑪ | NC |
| ⑫ | NC |

ALC and EEI operations

- ALC refers to automatic level control and EEI to shutter iris control. The video circuit of the KY-F32 employs a system that maintains the video level at a constant level through a combination of the lens's auto iris, continuously variable electronic shutter (EEI), and automatic level (sensitivity) control circuit (ALC).
- In low-light conditions, the automatic level control circuit is activated while, in brighter light, the electronic shutter operates. Moreover, if the iris is set to auto, the sensitivity, iris, and electronic shutter will all vary continuously to automatically ensure the optimum signal level at all times.
- In the ALC mode, sensitivity (gain) is increased between 0 dB and +18 dB. In the EEI mode, the electronic shutter automatically operates at a range from 1/60 to 1/1920 (U ver.), 1/50 to 1/1600 (E ver.) second depending on the strength of the lighting. This means that in dark conditions, the signal level will be adjusted by 3 stops of the iris whereas in bright situations, it will be adjusted by a range of 5 stops.
- When the camera's LENS mode is set to "MANUAL" (see "LENS" on page 22), the sensitivity and electronic shutter values vary continuously while the iris set value remains the same. This function is useful for shooting without changing the depth of field under changing illumination.

Illumination: lux

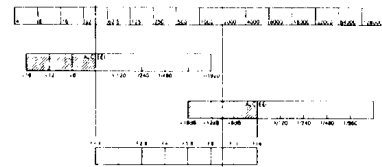

30

TECHNICAL INFORMATION

Full-time auto white balance

Full-time auto white balance is a function which automatically and continuously adjusts white balance as necessary. In some cases — such as when there is a single color on the screen, when the object is wearing a vivid color, or when the color temperature of the light source changes etc., — correct white balance may not be obtained. If this occurs, we recommend you adjust the white balance by referring to "White balance adjustment" on p.15.

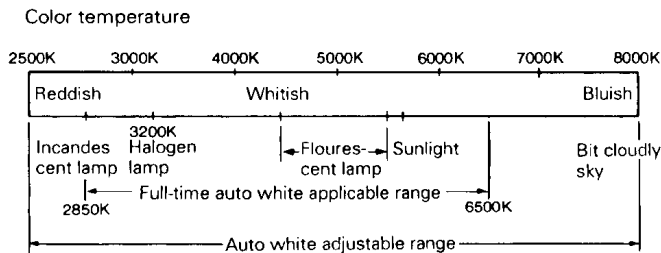

Operation principle of the electronic shutter (Example: 1/500 sec)

Electric charge is stored in a CCD image device for only 1/500 second before the signal is read out from the CCD device and the electric charges stored prior to that are discharged (swept out) in order to achieve a shutter speed of 1/500 second.

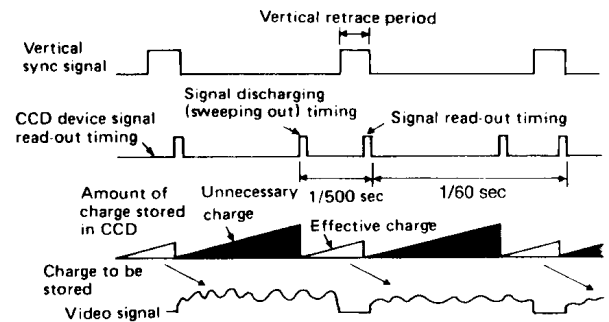

Cautions in the use of the electronic shutter mode

- The motion of the object will be seen as stroboscopic motion on the monitor TV screen as a 1/500 second picture is extracted every 1/60 (U ver.), 1/50 (E ver.) second.
- As flicker results under a periodic lighting such as a fluorescent lamp, it is necessary to use lighting which is free from excessive periodic changes such as an incandescent lamp.

- As the storage time of the CCD device is decreased to approximately 1/8, the drop in the amount of light will be by a factor of 1/8 of that in the normal mode. In shooting, it is necessary to increase the illumination by 8 times or increase light intensity by opening the lens aperture by 3 stops if there is sufficient light.

High-resolution mode

To increase the vertical resolution, a one line readout method is used for the CCD image sensing device. The mode activating this system is called the High-resolution mode for this camera.

Two signal readout methods are available for the CCD image sensing device: Field storage method and frame storage method.

The field storage method (2-line simultaneous readout) stores signals for one field (1/60 sec. (U ver.)), (1/50 sec. (E ver.)) while the frame storage method stores signals for one frame (1/30 sec. (U ver.)), (1/25 sec. (E ver.)). The former is used for the NORMAL mode and the latter is used for the HI-RESO mode.

- NORMAL mode (field storage, 2-line simultaneous readout)**
For field storage, 2 lines are mixed and read out simultaneously. (The combination of lines on odd fields and even fields are different.) This reduces vertical resolution. However, after-image lag is also reduced because the storage time is shorter than for frames.
As all signals are read out with one field, when analyzing the action using strobe radiation, one radiation is required for each field. If video signals are acquired for only one field, flickering occurs.

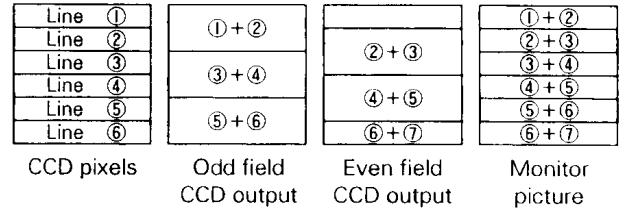

- High-resolution mode (frame storage, single line readout)**
In the HI-RESO mode, as only one line is read out, the vertical resolution is increased. However, the storage time is for each frame. Thus, if the object moves within 1/30 sec., after-image lag will result.
This mode is best suited to shooting still or slow-moving subjects. When analyzing the action with strobe radiation, one radiation is sufficient for one frame.

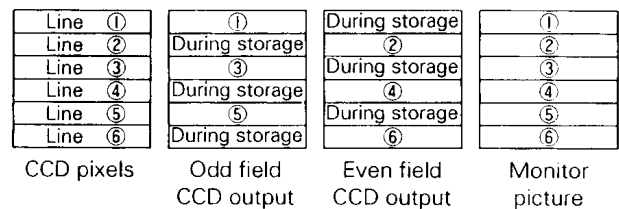

32

SPECIFICATIONS

Power supply : AA-P700 (OPTION)
 Remote control unit : RM-LP55/LP57 (OPTION)
 Pickup device : 1/2 inch interline CCD x 3
 Effective number of pixels : 380,000 pixels (U ver.)
 440,000 pixels (E ver.)
 Color separation optical system : F1.4, RGB 3-color separation prism
 Lens mount : Bayonet
 Color system : NTSC (wideband R-Y, B-Y encoder)
 PAL (wideband R-Y, B-Y encoder)
 Sync system : Internal/external
 Sensitivity : F9.5 (U ver.), F8 (E ver.), 2000 lux
 Actual-use minimum illuminance : 6 lux (U ver.), 7.5 lux (E ver.) (F1.4, +18 dB) 100 IRE video level
 S/N ratio : 60 dB (typical)
 Horizontal resolution : 750 TV lines (Y signal)
 580 TV lines (RGB signal)
 Registration : 0.05% (excluding lens characteristics)
 Contour correction : Horizontal; dual-edged
 Vertical; dual-edged
 Negative function : Provided
 High-resolution mode: Provided
 Electric gain : +6 dB, +9 dB, +12 dB, +18 dB, ALC
 Electronic shutter speed : Normal (1/60 sec. (U ver.)), (1/50 sec. (E ver.))
 1/100s (U ver.), 1/120s (E ver.) (flickerless), 250, 500, 1000, 2000, EEI
 External sync signal input : Composite video signal 1 V(p-p), 75 ohm or black burst signal 0.43 V(p-p) (U ver.), 0.45 V(p-p) (E ver.)

Color bars : Built-in SMPTE type color bars signal (U ver.)
 Built-in EBU type color bars signal (E ver.)
 Output signals
 • Composite video signal : 1 V(p-p)
 BNC connector one channel,
 D-SUB 9-pin connector one channel
 • Y/C signal Y : 1 V(p-p) 75 ohm (including sync)
 C : 0.286 V(p-p) (U ver.), 0.3 V(p-p) (E ver.)
 75 ohm (burst)
 D-SUB 9-pin connector one channel
 • RGB signal : 0.7 V(p-p), 75 ohm (without sync) each
 D-SUB 9-pin connector one channel
 • Component signal: Y : 1 V(p-p) 75 ohm
 R-Y/B-Y : 0.7 V(p-p) (U ver.),
 0.525 V(p-p) (E ver.) 75 ohm
 D-SUB 9-pin onnector one channel
 • Composite sync signal : 2 V(p-p), 75 ohm
 D-SUB 9-pin connector one channel
 Remote connector : Applicable to the RM-LP55/LP57
 Power supply : 12 V DC (10.5 to 15 V)
 Power consumption : 0.7 A (camera only), 1.1 A (maximum load)
 Ambient temperature range : -5°C to 40°C (23°F to 104°F)
 Weight : 850 g
 Accessories : DC cable (VC462-2: 2 m) x 1 1

Design and specifications are subject to change without prior notice.

■ Dimensions (unit: mm)

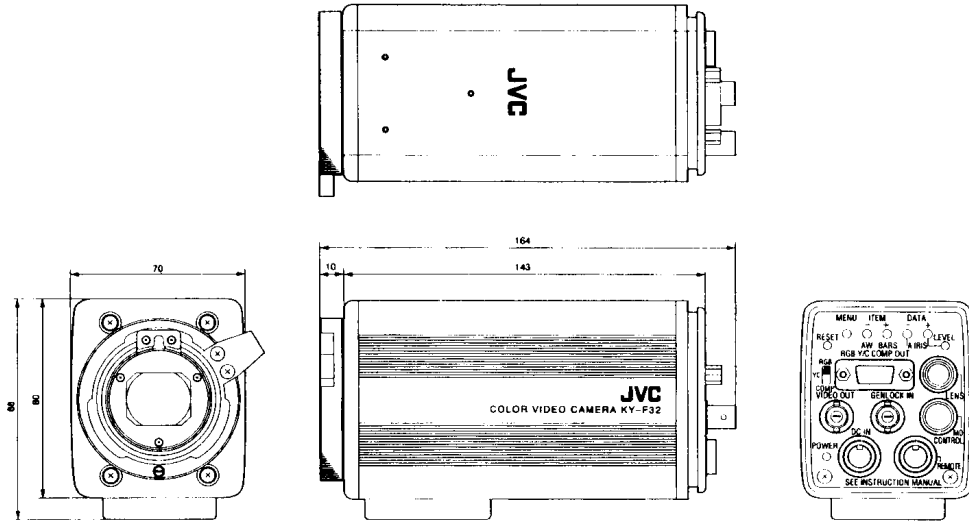

JVC

VICTOR COMPANY OF JAPAN, LIMITED