



COLOR VIDEO MONITOR

TM-1650SU

INSTRUCTIONS

For Customer Use:

Enter below the Serial No. which is located on the rear of the cabinet. Retain this information for future reference.

Model No. : TM-1650SU

Serial No. : _____

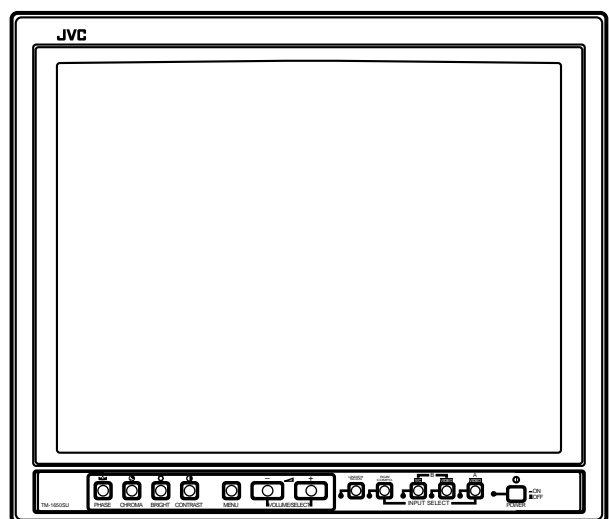

Thank you for purchasing this JVC color video monitor. Before using it, read and follow all instructions carefully to take full advantage of the monitor's capabilities.

SAFETY PRECAUTIONS

WARNING :

TO PREVENT FIRE OR SHOCK HAZARDS, DO NOT EXPOSE THIS MONITOR TO RAIN OR MOISTURE.

CAUTION :

To reduce the risk of electric shock, do not remove cover. Refer servicing to qualified service personnel.

This monitor is equipped with a 3-blade grounding-type plug to satisfy FCC rule. If you are unable to insert the plug into the outlet, contact your electrician.

FCC INFORMATION (U.S.A. only)

CAUTION: Changes or modification not approved by JVC could void the user's authority to operate the equipment.

NOTE: This equipment has been tested and found to comply with the limits for a Class B digital device, pursuant to Part 15 of the FCC Rules. These limits are designed to provide reasonable protection against harmful interference in a residential installation. This equipment generates, uses and can radiate radio frequency energy and, if not installed and used in accordance with the instructions, may cause harmful interference to radio communications. However, there is no guarantee that interference will not occur in a particular installation. If this equipment does cause harmful interference to radio or television reception, which can be determined by turning the equipment off and on, the user is encouraged to try to correct the interference by one or more of the following measures:

- Reorient or relocate the receiving antenna.
- Increase the separation between the equipment and receiver.
- Connect the equipment into an outlet on a circuit different from that to which the receiver is connected.
- Consult the dealer or an experienced radio/TV technician for help.

■ PRECAUTIONS

- Use only the power source specified on the unit. (120 V AC, 50/60 Hz)
- Keep flammable material, water, and metal objects away from the unit – especially the interior of the unit.
- This unit incorporates high voltage circuitry. For your own safety and that of your equipment, do not attempt to modify or disassemble this monitor. There are no user-serviceable parts inside.
- Unplug the monitor when you're not going to be using it for a long period.

■ HANDLING

- Avoid shocks or vibrations. These may damage the unit and cause it to malfunction.
- Do not block the ventilation slots.
- Do not expose this unit to high temperatures. Extended exposure to direct sunlight or a heater could deform the cabinet or cause the performance of internal components to deteriorate.
- Do not place the unit near appliances generating strong electric or magnetic fields. There can generate picture noise and instability.
- Keep the monitor clean by wiping the cabinet and CRT screen with a piece of soft cloth. Do not apply thinner or benzine. These chemicals can damage the finish and erase printed letters. When the unit is excessively dirty, use a diluted neutral cleanser, then wipe away the cleanser with a dry cloth.

SCREEN BURN

- It is not recommended to keep a certain still image displayed on screen for a long time as well as displaying extremely bright images on screen. This may cause a burning (sticking) phenomenon on the screen of cathode-ray tube. This problem does not occur as far as displaying normal video playback motion images.

CONTENTS





SAFETY PRECAUTIONS	2
CONTROLS AND FEATURES	4
HOW TO HANDLE BASIC OPERATIONS	7
HOW TO USE THE MENU FUNCTIONS	8
HOW TO INITIALIZE THE SETTING	12
BASIC CONNECTION EXAMPLE	13
TROUBLESHOOTING.....	15
SPECIFICATIONS	16

CONTROLS AND FEATURES

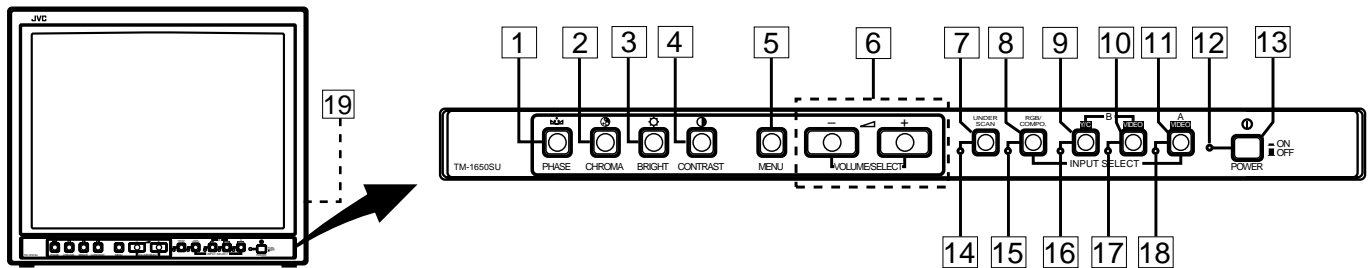
FRONT VIEW

<Front Panel>



- 1 Phase button [PHASE ]**
 Press this button to set the picture hue adjustment mode. Adjust the value with the VOLUME/SELECT buttons. Also used as a control button in the menu function mode.
- 2 Chroma button [CHROMA ]**
 Press this button to set the picture color density adjustment mode. Adjust the value with the VOLUME/SELECT buttons. Also used as a control button in the menu function mode.
- 3 Brightness button [BRIGHT ]**
 Press this button to adjust picture brightness. Adjust the value with the VOLUME/SELECT buttons. Also used as a control button in the menu function mode.
- 4 Contrast button [CONTRAST ]**
 Press this button to adjust picture contrast. Adjust the value with the VOLUME/SELECT buttons. Also used as a control button in the menu function mode.
- 5 Menu button [MENU]**
 Displays and disappears the <MENU> screen. Pressing the PHASE button with the Menu button depressed will display the <SET-UP MENU> screen.
- 6 Volume/Select buttons [VOLUME/SELECT -  +]**
 Adjusts the speaker volume. Also used as a control button in the menu function mode.
- 7 Under Scan button [UNDER SCAN]**
 Reduces the screen size to display the whole screen. Press the button again to quit Under Scan.
- 8 Input RGB/COMPO. button [INPUT SELECT RGB/ COMPO.]**
 Selects the video signal input to the RGB/COMPO. (analog RGB/Y, B-Y, R-Y) terminal and the audio signal input to the AUDIO RGB/COMPO. terminal on the rear panel. When selected, the input RGB/COMPO. indicator **15** lights.

Note:

 - RGB or COMPONENT signals can be selected in the <MENU> screen.
- 9 Input B (Y/C) button [INPUT SELECT B Y/C]**
 Selects the video signal input to the VIDEO B (Y/C) terminal and the audio signal input to the AUDIO B terminal on the rear panel. When selected, the input B (Y/C) indicator **16** lights.
- 10 Input B (VIDEO) button [INPUT SELECT B VIDEO]**
 Selects the video signal input to the VIDEO B terminal and the audio signal input to the AUDIO B terminal on the rear panel. When selected, the input B (VIDEO) indicator **17** lights.
- 11 Input A (VIDEO) button [INPUT SELECT A VIDEO]**
 Selects the video signal input to the VIDEO A terminal and the audio signal input to the AUDIO A terminal on the rear panel. When selected, the input A (VIDEO) indicator **18** lights.
- 12 Power indicator**
 Lights in green when the power is ON.
Lit : When the power is on.
Unlit : When the power is off.
- 13 Power switch [POWER ]**
 Press this switch to turn the power on or off.
ON : Power is turned on.
OFF : Power is turned off.
- 14 UNDER SCAN indicator**
 Lights in green when UNDER SCAN is selected.
- 15 Input RGB/COMPO. indicator**
 Lights in green when Input RGB/COMPO. is selected.
- 16 Input B (Y/C) indicator**
 Lights in green when Input B (Y/C) is selected.
- 17 Input B (VIDEO) indicator**
 Lights in green when Input B (VIDEO) is selected.
- 18 Input A (VIDEO) indicator**
 Lights in green when Input A (VIDEO) is selected.
- 19 Speaker**
 A built-in speaker is located inside the right side panel when the monitor is viewed from the front.

REAR VIEW

<Rear Panel>

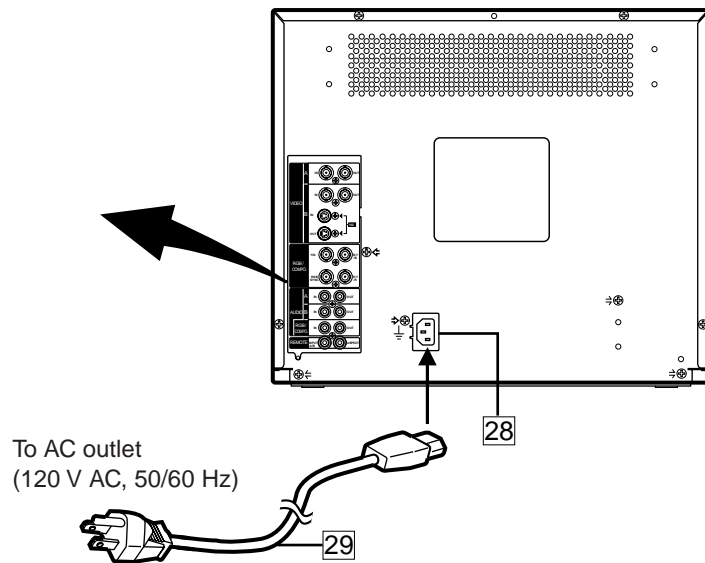
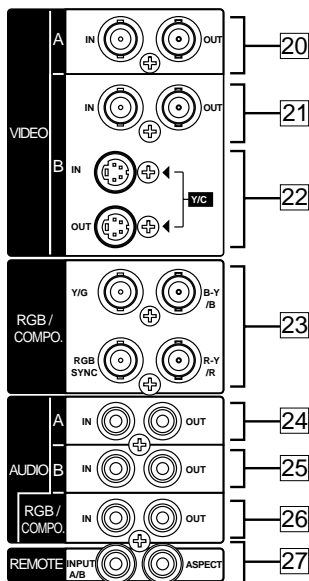

20 Video A terminals [VIDEO A IN/OUT]

Video signal input (IN) and output (OUT) terminals. The output terminal is bridge-connected.

IN : Video signal input terminal

OUT : Bridge-connected video signal output terminal

Notes:

* For corresponding audio signals, use the AUDIO A terminals [24].

* Also refer to BASIC CONNECTION EXAMPLE on page 13.

21 Video B terminals [VIDEO B IN/OUT]

Video signal input (IN) and output (OUT) terminals. The output terminal is bridge-connected.

IN : Video signal input terminal

OUT : Bridge-connected video signal output terminal

Notes:

* For corresponding audio signals, use the AUDIO B terminals [25].

* Also refer to BASIC CONNECTION EXAMPLE on page 13.

22 Video B (Y/C) terminals [VIDEO B Y/C IN/OUT]

Y/C (S-Video) signal input (IN) and output (OUT) terminals.

The output terminal is bridge-connected.

IN : Y/C-separated (S-video) signal input terminal

OUT : Bridge-connected Y/C-separated (S-video) signal output terminal

Notes:

* For corresponding audio signals, use the AUDIO B terminals [25].

* Also refer to BASIC CONNECTION EXAMPLE on page 14.

23 RGB/COMPO. terminals

Input terminals for analog RGB/Y, B-Y, R-Y signals.

* The RGB SYNC input terminal is for the external synchronization (composite synchronization) signal when an analog RGB signal is input.

Notes:

• For corresponding audio signals, use the AUDIO RGB/COMPO. terminal [26].

• When an analog RGB signal is input, be sure to input the external synchronization signal to the RGB SYNC terminal.

• Also refer to BASIC CONNECTION EXAMPLE on page 14.

24 Audio A terminal [AUDIO A IN/OUT]

Input (IN) and output (OUT) terminals for the audio signal corresponding to the VIDEO A terminals [20]. The output terminal is bridge-connected.

IN : Audio signal input terminal

OUT : Bridge-connected audio signal output terminal

Notes:

* For corresponding video signals, use the VIDEO A terminal [20].

* Also refer to BASIC CONNECTION EXAMPLE on page 13.

CONTROLS AND FEATURES (cont'd)

REAR VIEW

<Rear Panel>

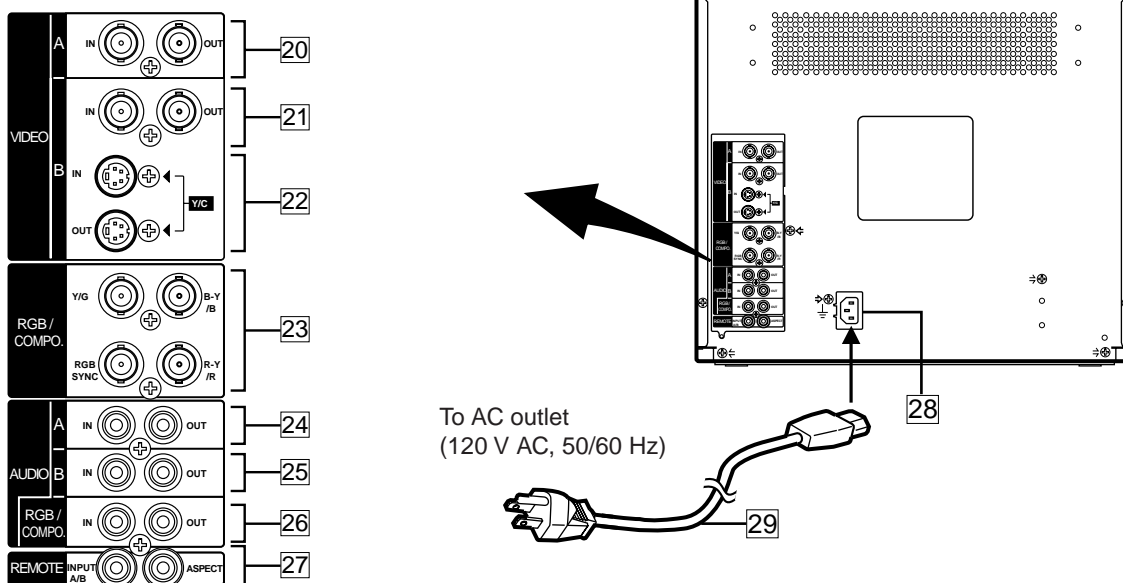

25 Audio B terminals [AUDIO B IN/OUT]

Input (IN) and output (OUT) terminals for the audio signals corresponding to the VIDEO B terminals [21] or VIDEO B (Y/C) terminals [22]. The output terminal is bridge-connected.

IN : Audio signal input terminal

OUT : Bridge-connected audio signal output terminal

Notes:

- * For corresponding video signals, use the VIDEO B terminals [21] or VIDEO B (Y/C) terminals [22].
- * Also refer to BASIC CONNECTION EXAMPLE on page 13.

26 Audio RGB/COMPO. terminals [AUDIO RGB/COMPO. IN/OUT]

Input (IN) and output (OUT) terminals for the audio signals corresponding to the RGB/COMPO. terminals [23]. The output terminal is bridge-connected.

IN : Audio signal input terminal

OUT : Bridge-connected audio signal output terminal

Notes:

- For corresponding video signals, use the RGB/COMPO. terminals [23].
- Also refer to BASIC CONNECTION EXAMPLE on page 14.

27 Remote terminals [REMOTE INPUT A/B, ASPECT]

Remote terminals for external control. Selecting INPUT A or INPUT B and the ASPECT RATIO is available via external control. External control is set in the <SET-UP MENU> screen.

To use external control, you must build a switch cable and connect it to the REMOTE terminals.

External control functions	External control switch	
	Open circuit (open)	Closed circuit (short)
ASPECT RATIO	4-3 (4:3)	16-9 (16:9)
INPUT A/B	INPUT A	INPUT B

Note:

- Also refer to BASIC CONNECTION EXAMPLE on pages 13 and 14.

28 AC Inlet [AC IN]

Power input connector. Connect the provided AC power cord [29] to an AC outlet (120 V AC, 50/60 Hz).

29 Power cord

Connects the provided power cord (120 V AC, 50/60 Hz) to the AC IN connector.

HOW TO HANDLE BASIC OPERATIONS

BASIC OPERATION

1. Press the POWER switch to turn on the power.

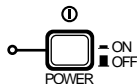

- ON : Power turns ON. (Power indicator: lit)
- OFF : Power turns OFF. (Power indicator: unlit)

2. Press the INPUT SELECT button to choose input.

Select video/audio signals input to terminals on the rear panel. The selected INPUT SELECT indicator lights in green.

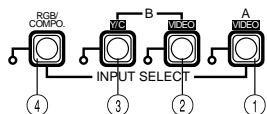

INPUT SELECT button	Terminals on the rear panel	
	Video signal input	Audio signal input
① Input A (VIDEO)	VIDEO A terminal	AUDIO A terminal
② Input B (VIDEO)	VIDEO B terminal	AUDIO B terminal
③ Input B (Y/C)	VIDEO B (Y/C) terminal	
④ Input RGB/COMPO.	RGB/COMPO. terminal (RGB/Y, B-Y, R-Y)	AUDIO RGB/COMPO. terminal

* RGB or COMPONENT signals can be selected in the <MENU> screen.

3. Press the VOLUME/SELECT button to adjust the speaker volume.



Press this button to display the speaker volume level on the screen.

- + : The Built-in speaker volume is increased. (00 → 50)
- : The Built-in speaker volume is decreased. (50 → 00)
- * Screen indication will disappear about 10 seconds after operating.

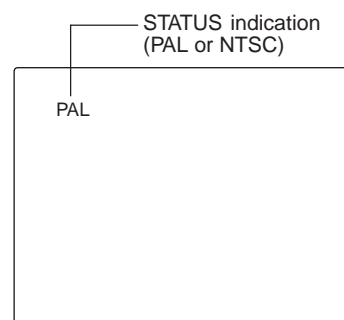

About the STATUS indication

- With the COLOR SYSTEM setting set to AUTO mode, when you turn on the power or select inputs, the color system indication appears for about 3 seconds on the screen while PAL or NTSC signals are being detected. It does not appear when receiving a B/W signal or when no signal is input. Refer to page 8 for more information about COLOR SYSTEM setting and page 10 for more information about STATUS indication setting.

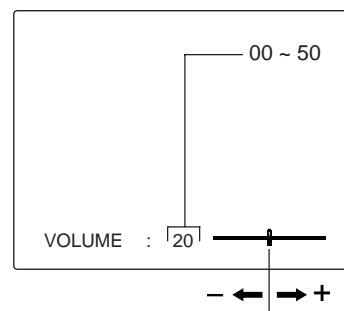

PICTURE ADJUSTMENT

1. Press select button corresponding to the item you want to adjust.

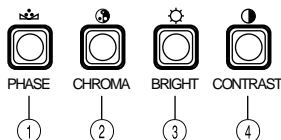

The item you select is displayed on the screen.

- ① PHASE (☼) : Phase control
- ② CHROMA (⊕) : Chroma control
- ③ BRIGHT (☀) : Brightness control
- ④ CONTRAST (●) : Contrast control

2. Adjust with the VOLUME/SELECT button.



Items	VOLUME/SELECT button	
	-	+
PHASE (Phase)	reddish	greenish
CHROMA (Chroma)	lighter	deeper
BRIGHT (Brightness)	darker	brighter
CONTRAST (Contrast)	lower	higher

* Screen indication will disappear about 10 seconds after operating.

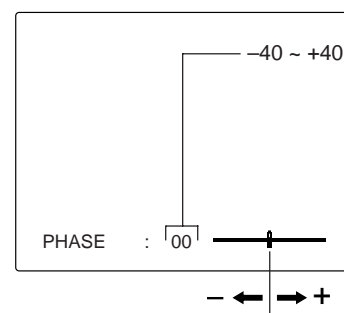

Notes:

- Phase control is effective only in the NTSC color system mode.
- Chroma control is not effective when receiving B/W or when no signal is input. (Except when a component signal is input.)
- When CHROMA is adjusted to "- 40," the picture becomes less colorful.
- "NO EFFECT" is displayed (for about 3 seconds) when your selected function has no effect.

HOW TO USE THE MENU FUNCTIONS

DISPLAY AND SELECTION IN THE <MENU> SCREEN MODE (SETTING)

You can set the following menu items.
Set them depending on your needs.

- SHARPNESS
- COLOR TEMP.
- COLOR SYSTEM
- ASPECT RATIO
- RGB/COMPONENT
- COMPO. LEVEL
- BLUE CHECK

1. Press the MENU button.



The <MENU> screen is displayed.
* The screen automatically disappears when no operation is performed after about 5 minutes.

2. Press the PHASE () or CHROMA () button to select MENU items.



A selection mark (▶) is put next to the selected item.

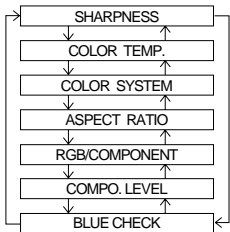

Front panel button	Function displayed	Contents
PHASE ()	▼	Forward selection mark (▶)
CHROMA ()	▲	Reverse selection mark (▶)

3. Press the VOLUME/SELECT button to set.



Front panel button	Function displayed	Contents
VOLUME/SELECT (+)	+	Increase (to max. value)
	▶	Forward the setting value
VOLUME/SELECT (-)	-	Decrease (to min. value)
	◀	Reverse the setting value

Menu items	Purpose	Setting range
SHARPNESS	Picture sharpness	00 ↔ +1 ↔ +39 ↔ +40
COLOR TEMP.	Color temperature of white balance	9300 ↔ 6500
COLOR SYSTEM	Color system	AUTO ↔ NTSC ↔ AUTO ↔ PAL ↑ ↓
ASPECT RATIO	Aspect ratio	4 - 3 ↔ 16 - 9
RGB/COMPONENT	Input RGB/COMPO. signal system	RGB ↔ COMPO.
COMPO. LEVEL	Component level	↕ +01 ↔ +9 ↔ +10 0 ↕ -01 ↔ -39 ↔ -40
BLUE CHECK	Blue check ON/OFF	OFF ↔ ON

4. If you want to set the other menu items, repeat procedures 2 and 3.

5. Press the MENU button to quit.



Front panel button	Function displayed	Contents
MENU	EXIT	Quit (or Release) the <MENU> screen

<MENU> screen

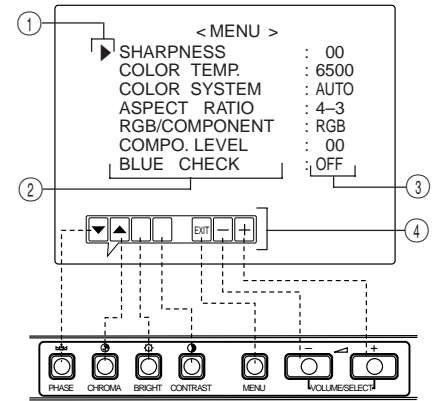

<Front panel button>

- ① Selection mark (▶): Indicates the menu item you select.
- ② Menu item: Menu items you can select.
- ③ Setting display: Indicates the current settings (value).
- ④ Function display: The functions of the front panel buttons (7 buttons on the left) correspond to the function displayed.

Function displayed	Contents
▼	Forward the menu item.
▲	Reverse the menu item.
-	Lower the adjustment value. (to the minimum)
+	Raise the adjustment value. (to the maximum)
▶	Forward the setting value.
◀	Reverse the setting value.
EXIT	Exits the <MENU> screen.

Notes:

- When the screen aspect ratio is set to 16 - 9 (16:9) in ASPECT RATIO, the picture will be vertically reduced.
- When REMOTE is displayed in the ASPECT RATIO or RGB COMPONENT status, it is not possible to set these items because ASPECT REMOTE or INPUT REMOTE in the <SET-UP MENU> is set to valid. Use the external control function or set ASPECT REMOTE or INPUT REMOTE to invalid (OFF) to make setting possible.
- The BLUE CHECK function is not memorized. After the power is turned off and on again, BLUE CHECK is automatically set to OFF. Refer to page 9 for more information about the BLUE CHECK function.
- When selecting COMPONENT, adjust CHROMA GAIN (COLOR) in the COMPO. LEVEL item first, then input a standard signal from the device used with the monitor and adjust CHROMA GAIN with BLUE CHECK. Refer to page 9 for more information about initializing COMPO. LEVEL.

How to use the BLUE CHECK function

Input the standard color-bar signal for your TV system and display it on the screen. When the BLUE CHECK function is ON, the red and green signals are cut and only the blue signal is displayed. The BLUE CHECK function adjusts and checks CHROMA (COLOR) GAIN and PHASE.

Make sure that COMPO. LEVEL has been initialized when a component signal is input.

[Procedure]

1. Input the standard color-bar signal for your TV system and display it on the screen.
2. Set the BLUE CHECK function in the <MENU> screen to ON and then press the MENU button to quit the <MENU> screen.
3. Press the CHROMA button to adjust the chroma so that the blue bars on the left and right sides of the screen have the same brightness.
4. (Only when an NTSC signal is input) Press the PHASE button to adjust the phase so that the two blue bars at the center of the screen have the same brightness.
5. (Only when an NTSC signal is input) Repeat procedures 3 and 4 for the adjustment so that all four blue bars on the screen have the same brightness.

When the adjustment is complete, set the BLUE CHECK function to OFF.

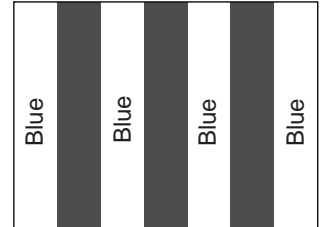

Note:

- The BLUE CHECK function is not memorized. After the power is turned off and on again, BLUE CHECK is automatically set to OFF.

● Initializing COMPO. LEVEL (when a component signal is input)

When a component signal is input, be sure to adjust (initialize) the COLOR offset in COMPO. LEVEL.

[Procedure]

1. Input the standard color-bar signal for your TV system and display it on the screen.
2. Set the BLUE CHECK function in the <MENU> screen to ON.
3. Select COMPO. LEVEL in the <MENU> screen and then adjust it with VOLUME +/- buttons so that the blue bars on the left and right sides of the screen have the same brightness.
4. Quit the <MENU> screen with the BLUE CHECK function ON.
5. Make sure that the blue bars on the left and right sides of the screen have the same brightness.
6. Repeat procedures 3, 4 and 5 for the adjustment so that the blue bars on the left and right sides of the screen have the same brightness.

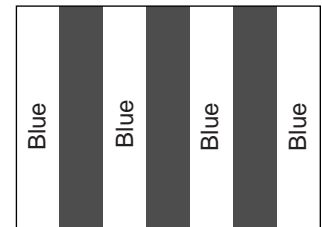

HOW TO USE THE MENU FUNCTIONS (cont'd)

DISPLAY AND SELECTIONS IN THE <SET-UP MENU> MODE (SETTING)

You can set the following set-up menu items.

- H. POSITION
- V. POSITION
- WHITE BALANCE
- CONTROL LOCK
- STATUS DISPLAY
- INPUT REMOTE
- ASPECT REMOTE

Notes:

- Parameters for H. POSITION and V. POSITION can be set separately depending on the video input (Input A (VIDEO), Input B (VIDEO), Input B (Y/C) or Input RGB/COMPO.) selected by the input select buttons on the front panel. Select the required video input with the input select buttons on the front panel in advance.
- WHITE BALANCE can be set individually at 6500 or 9300 for the color temperature value. Set COLOR TEMP. to the value 6500 or 9300 in the <MENU> screen in advance.

1. While pressing the MENU button, press the PHASE () button.



The <SET-UP MENU> screen is displayed.
* The screen automatically disappears when no operation is performed after about 5 minutes.

2. Press the PHASE () or CHROMA () button to select the desired menu item.



A selection mark (▶) is put next to the selected item.

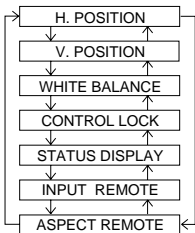

Front panel button	Function displayed	Contents
PHASE ()	▼	Forward selection mark (▶)
CHROMA ()	▲	Reverse selection mark (▶)

3. Press the VOLUME/SELECT button to set.



Front panel button	Function displayed	Contents
VOLUME/SELECT (+)	+	Increase (to max. value)
	▶	Forward the setting value
	CUTO	Selects CUT OFF setting screen
VOLUME/SELECT (-)	-	Decrease (to min. value)
	◀	Reverse the setting value
	DRV	Selects DRIVE setting screen

Notes:

- For the WHITE BALANCE setting, select the CUT OFF or DRIVE setting screen, then select the buttons (PHASE/CHROMA/BRIGHT) corresponding to the function indicated (R/G/B).
- Press the EXIT (MENU) button to return to the <SET-UP MENU> screen.

<SET-UP MENU> screen

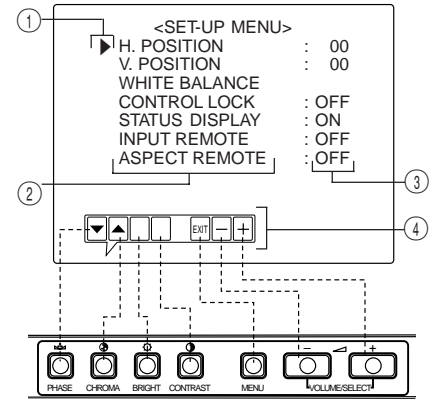

<Front panel button>

- ① Selection mark (▶): Indicates the menu item you select.
- ② Menu item: Menu items you can select.
- ③ Setting display: Indicates the current settings (value).
- ④ Function display: The functions of the front panel buttons (7 buttons on the left) correspond to the function displayed.

Function displayed	Contents
▼	Forward the menu item.
▲	Reverse the menu item.
-	Lower the adjustment value. (to the minimum)
+	Raise the adjustment value. (to the maximum)
▶	Forward the setting value.
◀	Reverse the setting value.
EXIT	Exit the <SET-UP MENU> screen. (release)
DRV	Selects DRV adjustment.
CUTO	Selects CUT OFF adjustment.
R	Adjusts red signal level.
G	Adjusts green signal level.
B	Adjusts blue signal level.
DISP	Turns the ON-SCREEN display on or off. (This function is effective only in the DRIVE or CUT OFF adjustment mode.)

Set-up menu items	Purpose	Settings
H. POSITION	Adjusts the horizontal position of the screen (+ : Horizontal position shifts to the right/-: Horizontal position shifts to the left)	-05 ↔ -04 ←.....→ -01 ↔ 00 ↔ +01 ←.....→ +04 ↔ +05
V. POSITION	Adjusts the vertical position on the screen (+: Vertical position moves down/-: Vertical position moves up)	-05 ↔ -04 ←.....→ -01 ↔ 00 ↔ +01 ←.....→ +04 ↔ +05
WHITE BALANCE	Adjusts the white balance	Selects DRIVE (DRV) or CUT OFF (CUTO) adjustment. Screen setting is changed to the selected setting mode. Select R/G/B buttons corresponding to the function display to adjust.
DRIVE R.DRIVE	Adjusts red level	-20 ↔ -19 ←.....→ -01 ↔ 00 ↔ +01 ←.....→ +19 ↔ +20
B.DRIVE	Adjusts blue level	-20 ↔ -19 ←.....→ -01 ↔ 00 ↔ +01 ←.....→ +19 ↔ +20
CUT OFF R. CUT OFF	Adjusts red cut off	-20 ↔ -19 ←.....→ -01 ↔ 00 ↔ +01 ←.....→ +19 ↔ +20
G. CUT OFF	Adjusts green cut off	-20 ↔ -19 ←.....→ -01 ↔ 00 ↔ +01 ←.....→ +19 ↔ +20
B. CUT OFF	Adjusts blue cut off	-20 ↔ -19 ←.....→ -01 ↔ 00 ↔ +01 ←.....→ +19 ↔ +20
CONTROL LOCK	Sets the operation buttons on the front panel to control lock mode	OFF ↔ ON
STATUS DISPLAY	Sets the status display of the color system	ON ↔ OFF
INPUT REMOTE	Sets external control of input selection (INPUT A/B)	OFF ↔ A/B
ASPECT REMOTE	Sets external control of the aspect ratio	OFF ↔ ON

4. To set the other set-up menu items, repeat the procedures 2 and 3.

5. Press the MENU button to quit.



Front panel button	Function displayed	Contents
MENU	EXIT	Quit (or Release) the <MENU> screen

Notes:

- When the CONTROL LOCK function is set to ON, pressing operation buttons on the front panel will display the message "CONTROL LOCK ON!" on the screen for about 3 seconds.
- The CONTROL LOCK function is maintained even when the power is turned off.
- To turn off the CONTROL LOCK function, while holding the MENU button press the PHASE button. Then set the CONTROL LOCK function to OFF.
- Even when the CONTROL LOCK function is set to ON, the following operations are available:
 - Power Switch operation
 - Volume control with the VOLUME/ SELECT buttons
 - External control when INPUT REMOTE or ASPECT REMOTE is valid
 - Display or disappear of the <SET-UP MENU> screen.
- The STATUS DISPLAY function can be set to display (ON) or not display (OFF) the present color system when the power is turned on or the input signal is changed. Refer to page 7 for more information.
- When the INPUT REMOTE function is valid (A/B), pressing the Input A, Input B or Input RGB/COMPO. buttons will display the message "REMOTE ON!" on the screen for about 3 seconds.
- The INPUT REMOTE function is valid (A/B) after quitting the <SET-UP MENU> screen.

HOW TO INITIALIZE THE SETTING

SCREEN DISPLAY AND SELECTIONS IN THE <SET-UP MENU> RESET MODE

You can set <MENU> and <SET-UP MENU> screen items, picture adjustment items and the volume level to their factory-set (initial) values.

1. Press the Power (ⓐ) Switch to turn the power OFF (⏻).

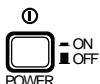

2. While pressing both MENU button and PHASE (ⓑ) button, press the Power (ⓐ) switch to turn the power ON (⏻).



The <SET-UP MENU> RESET screen is displayed.
* The screen automatically disappears when no operation is performed after about 5 minutes.

Note:

- The <SET-UP MENU> RESET screen will not be displayed if the MENU or PHASE buttons are pressed for a very short time. Keep pressing them until the display screen appears.

3. Setting

- Initialization is required.



Press the CONTRAST (ⓐ) button.
* Initialization is completed, and the <SET-UP MENU> RESET screen disappears.

- Initialization is not required.



Press the VOLUME/SELECT [+] or [-] button.
* Initialization is aborted, and the <SET-UP MENU> RESET screen disappears.

<SET-UP MENU> RESET screen

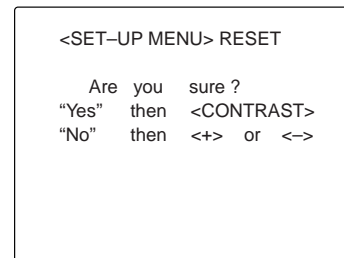

Initial settings

Sorts	Functions (Items)	Initialization (setting)
<MENU> screen	SHARPNESS	00
	COLOR TEMP.	6500
	COLOR SYSTEM	AUTO
	ASPECT RATIO	4-3
	RGB/COMPONENT	RGB
	COMPO. LEVEL	00
<SET-UP MENU> screen	BLUE CHECK	OFF
	H. POSITION	00
	V. POSITION	00
	WHITE BALANCE	
	R. CUT OFF	00
	G. CUT OFF	00
	B. CUT OFF	00
	R. DRIVE	00
	B. DRIVE	00
	CONTROL LOCK	OFF
STATUS DISPLAY	ON	
INPUT REMOTE	OFF	
ASPECT REMOTE	OFF	
Picture adjustment	PHASE	00
	CHROMA	00
	CONTRAST	00
	BRIGHT	00
Volume	VOLUME	20

BASIC CONNECTION EXAMPLE

Notes:

- Before connecting your system, make sure that all units are turned off.
- The illustration below shows some examples of different connections. Terminal connections may differ depending on the component connected. Be sure to refer to the instructions provided with the unit(s) you are connecting.
- Each pair of input (IN) and output (OUT) terminals are bridge-connected.
- If you're not connecting any equipment to a bridged output (OUT) terminal, be sure not to connect any other cables to the bridged output (OUT) terminal as this will cause the terminating resistance switch to open (auto terminate function).
- When making a bridge connection, connect the input (IN) and output (OUT) terminals on the monitor to separate video components. (For example, if both terminals are connected to the same VCR, resonance may occur except during playback. This is caused by the same video signal "looping" between the VCRs, and is not a malfunction.)
- Select the video input (INPUT A (VIDEO), INPUT B (VIDEO), INPUT B (Y/C) or INPUT RGB/COMPO.) with the INPUT SELECT buttons on the front panel.
- The ASPECT RATIO or INPUT A/B settings can be controlled via the REMOTE terminal by setting ASPECT REMOTE or INPUT REMOTE in the <SET-UP MENU> screen to valid. (Refer to pages 10 and 11.)

VIDEO A Connection Example (Select Input A (VIDEO))

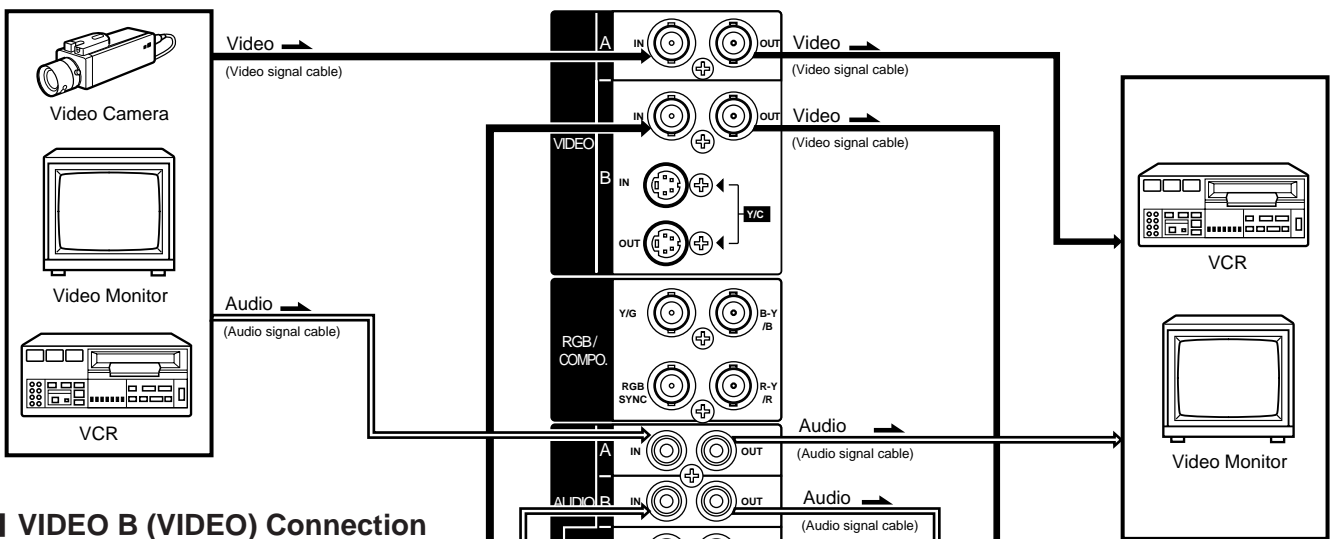

VIDEO B (VIDEO) Connection Example (Select Input B (VIDEO))

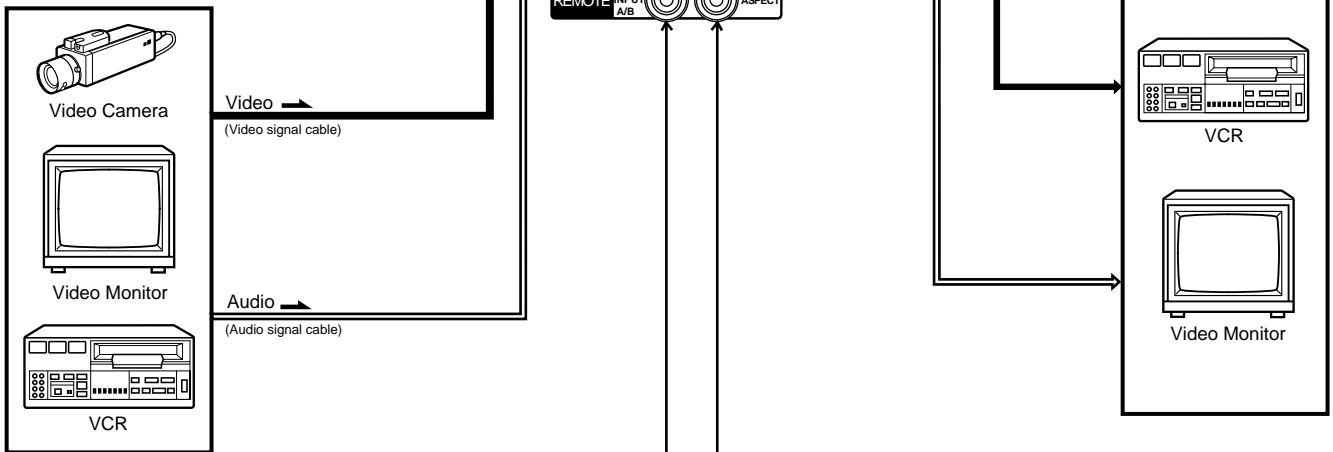

External control switch

open circuit (open) closed circuit (short)

REMOTE (Remote cable) → RCA pin

External control functions	External control switch	
	Open circuit (open)	Closed circuit (short)
INPUT A/B	INPUT A	INPUT B

External control switch

open circuit (open) closed circuit (short)

← REMOTE (Remote cable) RCA pin

External control functions	External control switch	
	Open circuit (open)	Closed circuit (short)
ASPECT RATIO	4-3 (4:3)	16-9 (16:9)

➔ : Signal Flow

BASIC CONNECTION EXAMPLE (cont'd)

VIDEO B (Y/C) Connection Example (Select Input B (Y/C))

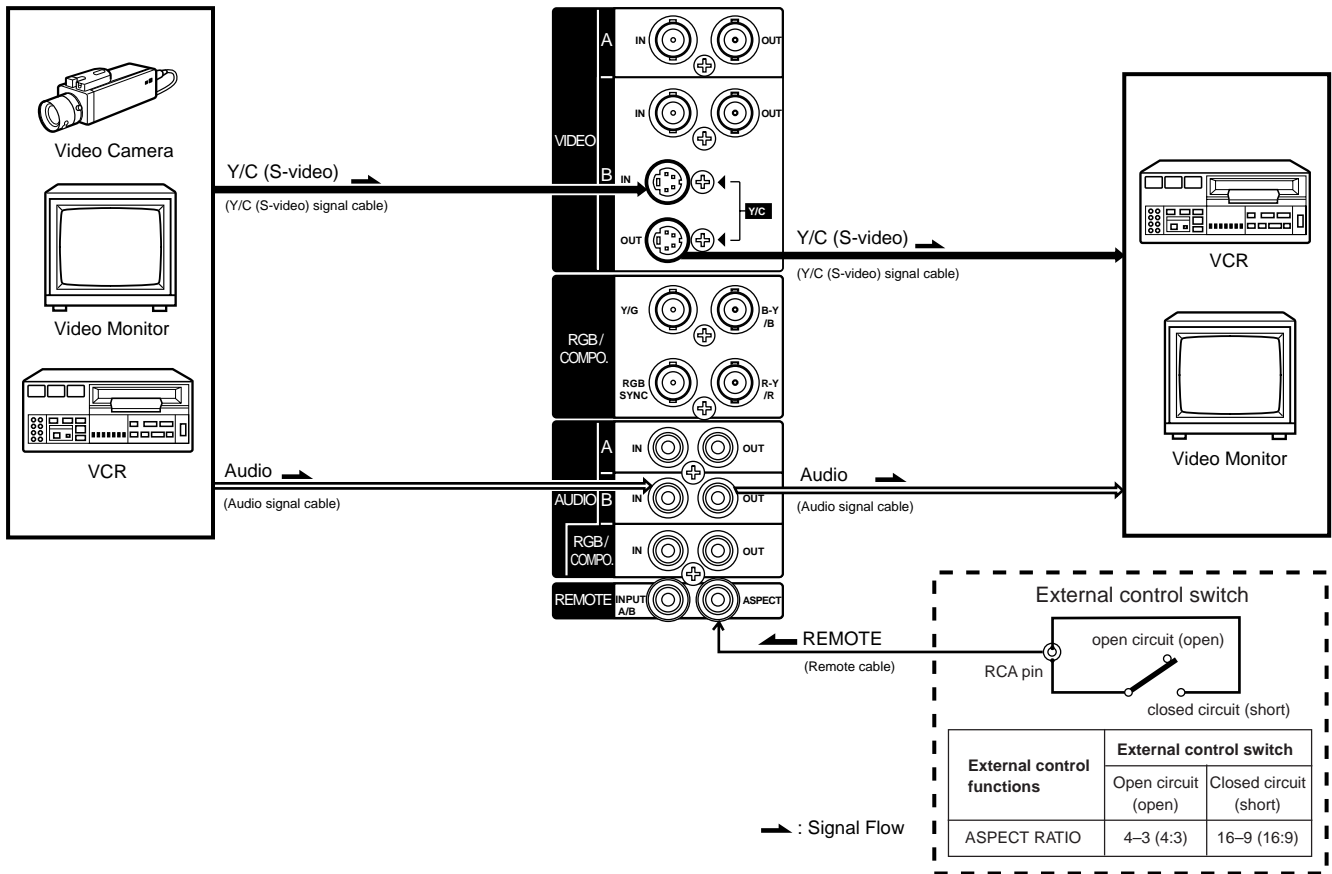

RGB/COMPO. Connection Example

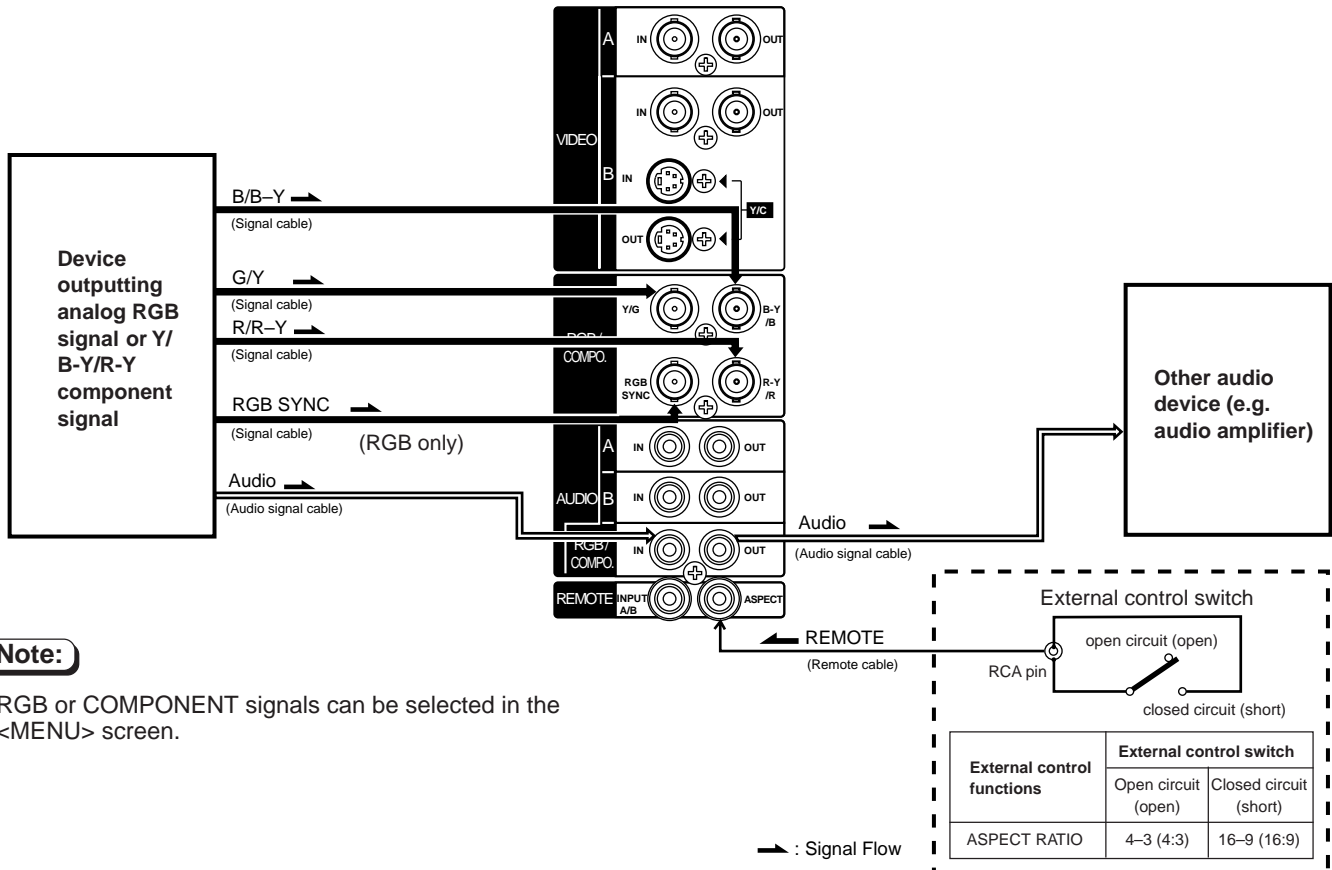

Note:

- RGB or COMPONENT signals can be selected in the <MENU> screen.

TROUBLESHOOTING

Solutions to common problems related to your monitor are described here. If none of the solutions presented here solves the problem, unplug the monitor and consult a JVC-authorized dealer or service center for assistance.

Problems	Points to be checked	Measures (Remedy)
No power supply.	Is the power plug loosened or disconnected?	Firmly insert the power plug.
No picture with the power on.	Is the video signal output from the connected component?	Set the connected component correctly.
	Is the input signal selected properly?	Select the required video signal input with the Input select button. (See page 7.)
	Is the video cable disconnected?	Connect the video signal cable firmly. (See pages 13 and 14.)
No sound.	Is the audio signal output from the connected component?	Set the connected component correctly.
	Is the volume output set to minimum?	Adjust the speaker volume with the VOLUME/SELECT button. (See page 7.)
	Is the audio cable disconnected?	Connect the audio signal cable firmly. (See pages 13 and 14.)
Shaking picture.	Is the monitor close to a device generating a strong magnetic field?	Move the device away from the monitor until the picture stabilizes.
No colors, wrong color, or dark picture.	Is the color system selected properly?	Set COLOR SYSTEM in the <MENU> screen to AUTO. (See page 8.)
	Has the picture control setting (CONTRAST, BRIGHT CHROMA or PHASE) been changed?	Set each picture control to the standard setting. (See page 7.)
	Is the RGB/COMPONENT signal selected properly?	Check the RGB/COMPONENT setting in the <MENU> screen. (See page 8.)
Unnatural, irregularly colored, or distorted picture.	Is the monitor close to a speaker, magnet or any other device generating a strong magnetic field?	Move the device away from the monitor and turn the monitor's power off. Wait at least 30 minutes, then turn the power on again.
Dark stripes appear at the top and bottom of the screen, picture vertically squeezed.	Is the aspect ratio set to 16:9?	Set ASPECT RATIO in the <MENU> screen to [4 : 3 (4 – 3)]. (See page 8.) When controlling externally, ASPECT RATIO should be set to [4 : 3 (4 – 3)]. (See pages 13 and 14.)
The overall picture size is too small.	Has the UNDER SCAN button been pressed so the UNDER SCAN indicator lights?	Press the UNDER SCAN button to turn off the indicator. (See page 4.)
Function buttons on the front panel do not function.	Has control of the buttons been locked? (Has the CONTROL LOCK function been set to ON?)	Set CONTROL LOCK in the <SET-UP MENU> screen to OFF. (See pages 10 and 11.)
The INPUT SELECT buttons do not function.	Is input selection under external control? (Has the INPUT REMOTE function been set to valid (A/B)?)	Set INPUT REMOTE in the <SET-UP MENU> screen to OFF. (See pages 10 and 11.)

The following are not malfunctions:

- When a bright still image (such as a white cloth) is displayed for a long period, it may appear to be colored. This is due to the structure of the cathode ray tube and will be deleted when another image is displayed.
- You experience a mild electric shock when you touch the picture tube. This phenomenon is due to a normal buildup of static electricity on the CRT and is not harmful.
- The monitor emits a strange sound when the room temperature changes suddenly. This is only a problem if an abnormality appears on the screen as well.
- If two or more monitors are operated next to each other, their images may shake or be distorted. This phenomenon is due to mutual interference; it is not a malfunction. Move the monitors away from each other until the interference disappears or turn the power off on any monitor that is not being used.

SPECIFICATIONS

■ Type	: Color video monitor	■ Audio power output	: 1 W (monaural)
■ Color system	: PAL, NTSC (3.58)	■ Built-in speaker	: 3-1/8" (8 cm) round x 1 impedance of 8 Ω
■ Picture tube	: 16" measured diagonally, flat-square type, 90° deflection, in-line gun, vertical line trio type (phosphor stripe pitch 0.42 mm)	■ Environmental conditions	: Operation temperature: 0 °C – 40 °C (32 °F – 104 °F) Operation humidity: 20 % – 80 % (non-condensing)
■ Effective screen size	: Width 13" (330 mm) Height 9-7/8" (250 mm) Diagonal 16-1/4" (410 mm)	■ Power requirements	: 120 V AC, 50 Hz / 60 Hz
■ Scanning frequency	: (H) 15.734 kHz (NTSC) 15.625 kHz (PAL) (V) 59.94 Hz (NTSC) 50 Hz (PAL)	■ Power consumption	: 1.2 A (120 V AC)
■ Horizontal resolution	: 550 TV lines or more (Y/C input mode)	■ Dimensions	: Width 15-5/8" (395 mm) Height 13-1/4" (334 mm) Depth 16-5/8" (420.5 mm)
■ Input terminals		■ Weight	: 37.9 lbs (17.2 kg)
VIDEO A	: Composite video: 1 line, BNC connector x 2, 1 V (p-p), 75 Ω, negative sync (bridge connection possible, auto termination)	■ Accessory	: AC power cord [7.9 ft (2.4 m)] x 1
VIDEO B	: Composite video: 1 line, BNC connector x 2, 1 V (p-p), 75 Ω, negative sync (bridge connection possible, auto termination) Y/C-separated: 1 line, mini-DIN 4-pin connector x 2 Y: 1.0 V (p-p), 75 Ω C(BURST): 0.286 V (p-p), 75 Ω (NTSC), 0.3 V (p-p), 75 Ω (PAL) (bridge connection possible, auto termination)		
RGB/COMPO.	: Analog RGB: 1 line, BNC connector x 3 R, G, B: 0.7 V (p-p), 75 Ω RGB sync: 0.3 V (p-p) – 4 V (p-p), 75 Ω Y, R-Y, B-Y component: 1 line Y: 1 V (p-p), 75 Ω, negative sync R-Y, B-Y: 0.7 V (p-p), 75 Ω		
AUDIO A	: 1 line (monaural), RCA pin x 2 0.5 V (rms), high-impedance (bridge connection possible)		
AUDIO B	: 1 line (monaural), RCA pin x 2 0.5 V (rms), high-impedance (bridge connection possible)		
AUDIO RGB/COMPO.	: 1 line (monaural), RCA pin x 2, 0.5 V (rms), high-impedance (bridge connection possible)		
REMOTE INPUT A/B	: 1 line, RCA pin x 1		
REMOTE ASPECT	: 1 line, RCA pin x 1		

* Illustrations used in this manual are for explanatory purposes only. The appearance of the actual product may differ slightly.

* Dimensions and weight are approximate.

* E. & O. E. Design and specifications subject to change without notice.

■ Dimensions

Unit : inch (mm)

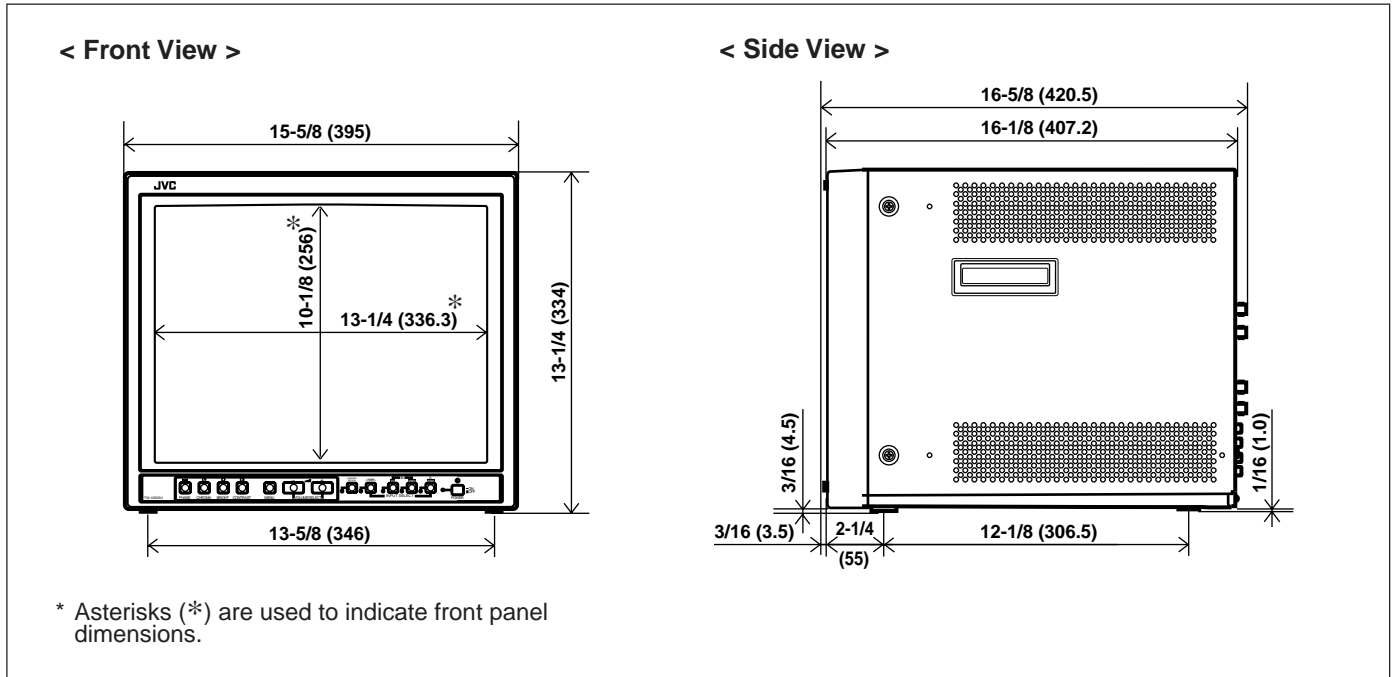

■ Y/C (Mini DIN 4 pin) terminal specification

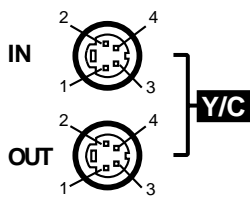

Pin No.	Signal
1	GND (Y)
2	GND (C)
3	Y
4	C

JVC[®]

JVC PROFESSIONAL PRODUCTS COMPANY
DIVISION OF US JVC CORP.
1700 Valley Road Wayne, NJ07470
JVC CANADA INC.

21 Finchdene Square, Scarborough Ontario M1X 1A7



LCT0371-002B-H
0700-Tu-V-JMT