

JVC[®]
PROFESSIONAL

D-ILA™ PROJECTOR
DLA-G15
DLA-S15



Outstanding Projection Im

—Breakthrough D-ILA™ projector offers high-contrast 350:1, 1500 ANSI lumen brightness and S-XGA resolution—

Large-size projection images with all the sharpness and clarity of a small-screen image — that's what you'll get with the D-ILA™ projector. The D-ILA™ (Direct Drive ILA) offers the most desirable of combinations — superb picture quality, operational ease, and affordability.

Featuring "true" S-XGA capability (1365 x 1024 pixels), the new D-ILA™ projector gives you the power to project the high-resolution graphics and CAD images created by today's advanced workstations and multimedia signal sources directly onto a large projection screen with no loss of quality whatsoever.

Better yet, the improved optical system is able to provide ultra-high brightness of 1500 ANSI lumens and a high-contrast ratio of 350:1. With the new D-ILA™ projector, you'll never have to put up with the washed-out images typical of conventional projectors — even in well-lit screening rooms. Instead, you'll enjoy clear, high-contrast images with vivid color reproduction and excellent text legibility, as well as finely detailed motion-picture images with natural gradations.

This versatile projector is also equipped to show moving images, and reproduce them on an extra-large screen with all the sharpness and clarity of the originals. Images projected on the screen with the D-ILA™ projector now rival the intensity and brilliance of those seen in a movie theater.

Combining the outstanding image reproduction and the user-friendliness, the new D-ILA™ projector takes projection images far beyond the limitations of conventional LCD and CRT projectors.



DLA-G15



DLA-S15

Image Quality

D-ILA™ — Projector Device Innovation

D-ILA™ Structure

The D-ILA™ device is a reflective type of LCD that delivers a higher aperture ratio (more than 93%) than a transmissive LCD panel, and is comprised of groups of pixels which correspond to each image dot. Also unlike conventional transmissive LCD panels (in which the driving transistor is mounted on the same surface as the pixels), the D-ILA™ driving IC substrate is located behind the liquid crystal layer. As a result, the D-ILA™ device can achieve higher brightness and higher resolution at the same time. In addition, thanks to the vertical alignment ("homeotropic" structure) of the liquid crystal layer, projected images also have much higher contrast.

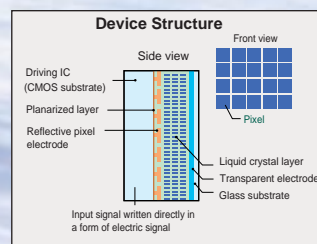

D-ILA™ Operation

The light from the xenon lamp travels through a polarized beam splitter (PBS), which is reflected off the D-ILA™ device, then passed through the projection lens and onto the screen.

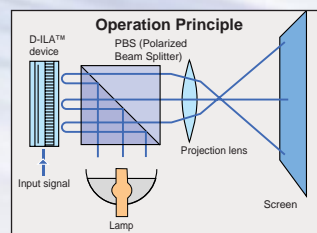

An Ideal Combination of Superb Picture User-Friendliness with Easy Setup

D-ILA™ device for next-generation image reproduction

The D-ILA™ (Direct Drive ILA) device provides high-resolution picture quality for the big screen. Utilizing a high-density reflective LCD with a homeotropic structure in which the LCD elements are aligned vertically, the D-ILA™ device produces extra-bright, high-resolution, high-contrast images.

Workstation-Quality Resolution, Brightness & Contrast

The D-ILA™ projector can project extra-high resolution images of up to 1,365 x 1,024 pixels. That means it can easily handle even the super-sharp clarity of an S-XGA (1,280 x 1,024 dots) image without scaling or loss of quality. And thanks to the “PS Combiner” that corrects optical waveforms to align the polarization, those images feature ultra-high brightness of 1500 ANSI lumens. And at the same time, they are displayed with a high-contrast ratio of 350:1. The result is extraordinarily clear and crisp images with higher text legibility and vivid color reproduction — even with moving images — without scaling or loss of quality.



Adaptive DPC Circuitry

The Adaptive DPC (Digital Pixel Conversion) technology optimizes picture quality no matter what the input signal resolution to assure smooth, clear images. Variable scanning frequency capability with horizontal scanning frequencies ranging from 15 kHz to 82 kHz assures compatibility with a wide range of source signals.

Digital Gamma Correction

Newly developed 10-bit Digital Gamma Correction circuitry is incorporated to facilitate more accurate gray scale and color reproduction. Even the intricately colored images created by graphics workstations can be clearly reproduced and displayed on the screen, thanks to improved color tracking and “real” black

reproduction capability that assures crisp blacks for cleaner, sharper, more detailed images.

Resizing Function

The combination of the high-definition D-ILA™ device with our innovative Adaptive DPC (Digital Pixel Conversion) circuitry enables the D-ILA™ projector to project “expanded” XGA images (1,024 x 768 pixels), S-VGA images (800 x 600 pixels), and VGA images (640 x 480 pixels), as well as fully dot-to-dot coincident S-XGA images (1,280 x 1,024 pixels). Optimum pixel conversion is performed by the incorporated Adaptive DPC circuitry according to the characteristics of the projection source signals. The result is amazingly natural picture reproduction.

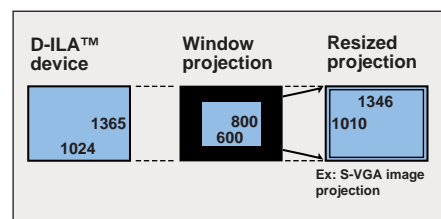

To project image data with a different number of pixels from that of the built-in device, you can use either the “Window projection” or “Resizing projection” method.

Resizing projection: Adaptive DPC circuit expands the original data to a full-screen image.

Window projection: If the source signal has lower resolution than the D-ILA™ device, the projected image appears at the same resolution as the input source, with a black frame around it.

Quality and



User-Replaceable Xenon Lamp

This Xenon lamp assures "true" color reproduction and a natural, realistic image — equivalent to that seen in movie theaters. With extra-high brightness of 1,500 ANSI lumens, projected images can be viewed comfortably even under fluorescent light. Moreover, unlike the metal halide lamps used in conventional projectors, the Xenon lamp can produce a projection image with "real" color.

Full signal input capability

As a projector designed for multimedia applications, the D-ILA™ projector is equipped with a full array of input connectors, allowing virtually any type of image signal to be displayed. Component inputs let you connect advanced motion-picture equipment, while the two provided PC inputs enable you to switch between source signals from two different computers. Future-ready DTV (Digital TV) capability is also provided and a variety of high-definition digital broadcast signal formats can be accommodated including 480i, 480p, 720p and 1080p.

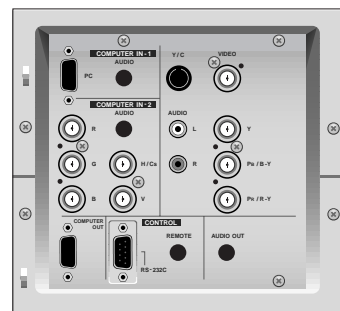

Quick & Easy Setup

The D-ILA™ projector's quick-start design makes it possible to start operation within 2 minutes of switching on the power. Single lens construction eliminates the need to adjust the various registrations, while the power zoom and power focus functions greatly reduce the need for projector alignment.

DLA-G15 Throw Distance vs. Screen Width

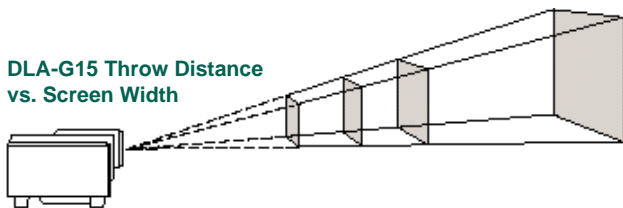

Screen Size					
(Diagonally)	(inches)	70	100	120	200
	(m)	1.42	2.03	2.44	4.06
(Width)	(ft)	4.66	6.66	8.00	13.32
	(m)	4.13	5.86	7.01	11.63
Throw Distance	Tele	(m)	13.55	19.22	22.99
		(ft)	2.77	3.91	4.57
	Wide	(m)	9.09	12.82	14.99
		(ft)			

User Friendly Design

Designed with easy handling in mind, the compact, lightweight projector can even be carried with one hand. Remote-control capability and a comprehensive on-screen display make this projector very easy to operate. An RS-232C serial communication port is also provided so the projector can be controlled directly from a computer.



DLA-S15 Rear Projector

Designed exclusively for rear projection use, the DLA-S15 incorporates a high-performance wide-angle 1:1 lens to provide accurate projection images.

DLA-S15 Throw Distance vs. Screen Width

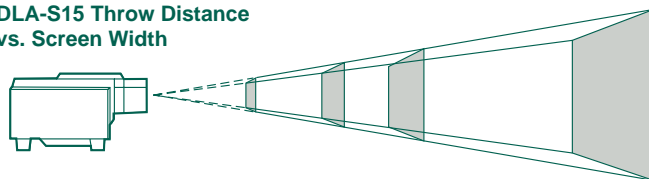

Screen Size					
(Diagonally)	(inches)	40	80	100	200
	(m)	0.81	1.63	2.03	4.06
(Width)	(ft)	2.66	5.33	6.66	13.32
	(m)	0.76	1.56	1.97	3.98
Throw Distance	(ft)	2.49	5.12	6.46	13.06
	(m)				

Other features include

- On-screen menu (6-language selectable)
- Auto-alignment function for automatic adjustment of tracking, phase and position
- Up-down/left-right inversion
- Selectable color temperature (High/Mid/Low)
- Selectable background color (when no signal is input)
- 1000 hours of lamp life
- Lamp life "warning" indicator
- Lamp "sleep" function — in the absence of any signal for a preset time (10 min., 20 min., 30 min. or 60 min. selectable), the lamp is automatically shut off for safety and power saving

An Expanding Range of Applications — the Projector of the Future

WORKSTATIONS

The D-ILA™ projector's extra-high resolution can project true S-XGA images created by advanced graphics computers or CAD workstations. Even 3D-modeling images are rendered beautifully on the large screen.

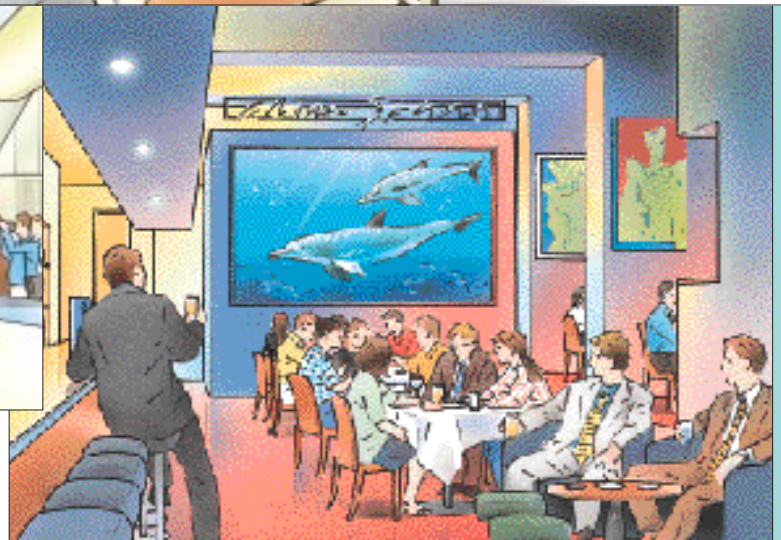
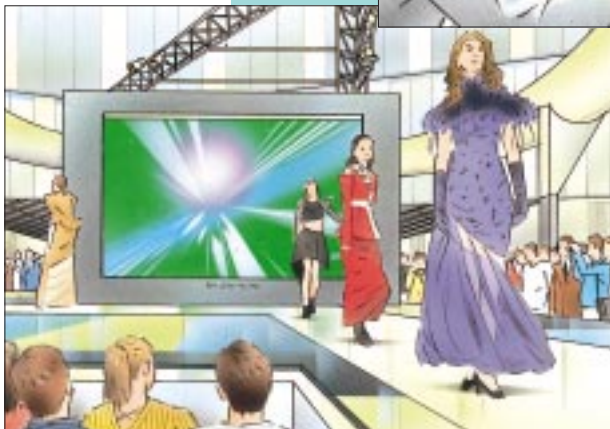
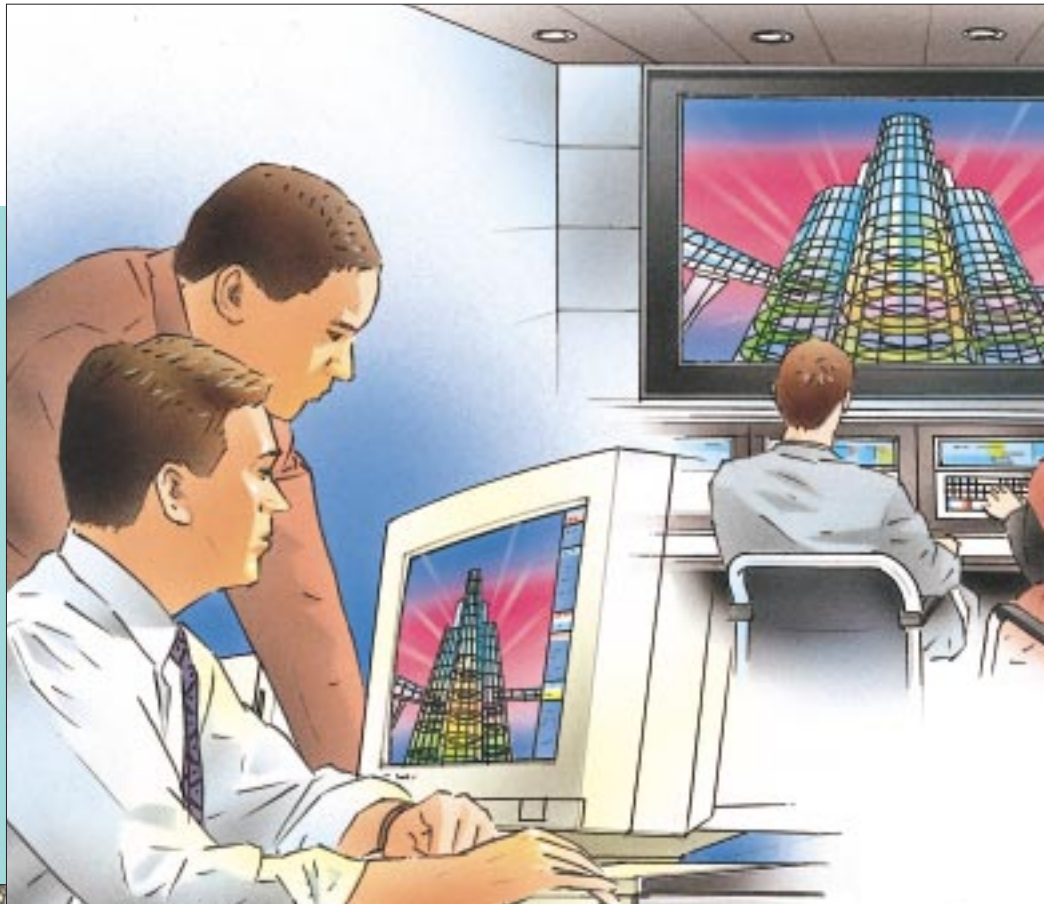

EVENTS

Eye-catching demonstrations can be performed at trade shows and other events. The crisp, high-contrast images on the large screen will be sure to catch the audience's attention.

ENTERTAINMENT

Coming standard with a variety of input capabilities, the D-ILA™ projector can project extra-bright, ultra-clear pictures from various motion-picture sources on a large screen. Now everyone can enjoy excellent color reproduction rivaling that seen in a movie theater, and experience front-row excitement.



D-ILA™
PROJECTOR

EDUCATION

The D-ILA™ projector's high brightness and high resolution make it ideal for presentations at academic conferences. Its large but detailed images are perfectly visible to everyone in attendance.

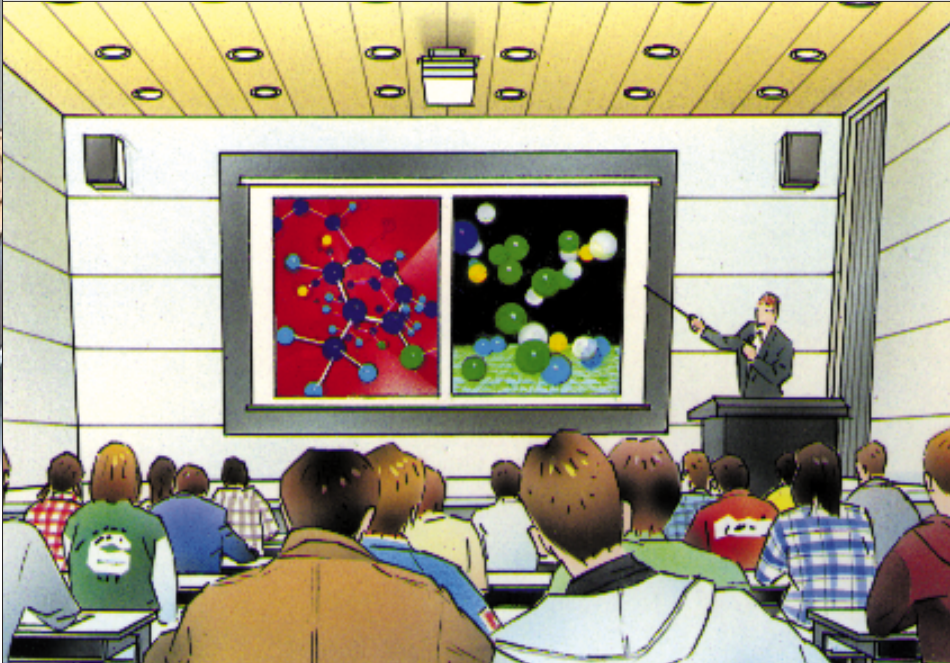

BUSINESS

Maximize the impact of your presentations with a display your audience won't soon forget. When connected to a computer, the D-ILA™ projector can turn an ordinary presentation into a stunning multimedia experience. Its extra-bright, high-contrast images are clearly visible to everyone in the audience even in a relatively bright room such as a conference room.



SPECIFICATIONS

● Image Device	3 D-ILA™ (0.9 inches diagonal)
● Projection Lens	
DLA-G15	2 : 1 – 3 : 1 (Throw distance : Screen width) Powered Zoom 50% off-axis
DLA-S15	1 : 1 (Throw distance : Screen width) on axis
● Brightness	1,500 ANSI lumens
● Resolution	1,365 x 1,024 pixels full coverage of S-XGA (1,280 x 1,024) Graphics (S-XGA, XGA, S-VGA, VGA)
● Contrast Ratio	More than 350 : 1
● Color Reproduction	16.7 million colors
● Scan Frequency	
Horizontal	15 – 82 kHz
Vertical	50 – 78 Hz
● Input	Analog RGB x 2 (D-Sub (female) x 1, R,G,B,H,V x 1) Y/C-Separated x 1 Composite x 1 Component x 1 (Y/R-Y/B-Y, Y/ P _B / P _R for HDTV)
● Output	
PC Monitor	D-sub (female)
Audio	Stereo
● Throw Distance	
DLA-G15	8.2 ft – 65.6 ft (2.5 m – 20 m)
DLA-S15	2.5 ft – 13.1 ft (0.76 m – 3.98 m)
● Screen Size	
DLA-G15	
Wide width	1,280 mm – 10,587 mm
diagonal	63" – 521"
Tele width	854 mm – 7,010 mm
diagonal	42" – 345"
DLA-S15 width	813 mm – 4,064 mm
diagonal	40" – 200"
● Lamp	420 watts, Xenon
● Audio	Built-in stereo speakers (1 W + 1 W stereo)
● Input Power	
U type	100 – 120 V, 50/60 Hz AC
● Power Consumption	660 W
● Dimensions (WxHxD)	
DLA-G15	16.73" x 9.68" x 13.35" (425 x 246 x 339 mm) excluding lens
DLA-S15	16.73" x 9.68" x 16.38" (425 x 246 x 416 mm) excluding lens
● Weight	
DLA-G15	32.56 lbs (14.8 kg)
DLA-S15	32.9 lbs (14.9 kg)
● Provided Accessories	AC cable, Wireless (infrared) remote control PC connection cable (D-sub 15-pin male – D-sub 15-pin male) Adapter for Macintosh AV cable, Audio cable, BNC-RCA adapter, Lens cap, Operation manual Battery for remote control unit x 2

Dimensions

Unit: inches (mm)

DLA-G15

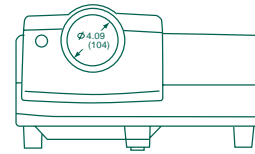
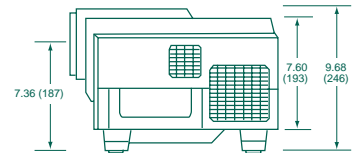
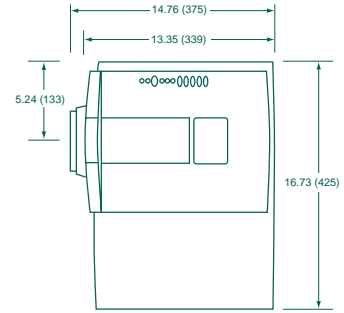

DLA-S15

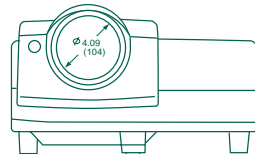
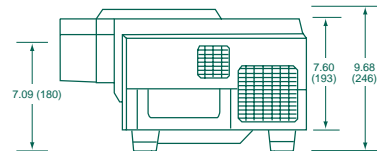
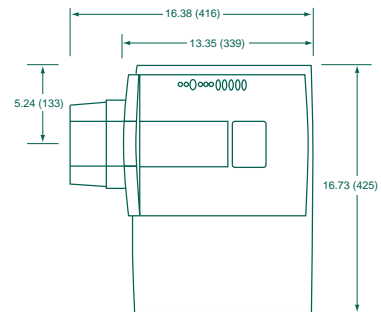

D-ILA is a trademark of Victor Company of Japan, Limited.

Design and specifications subject to change without notice.

JVC®

DISTRIBUTED BY

Copyright © 2000, Victor Company of Japan, Limited (JVC). All Rights Reserved.