

JVC

V.NETWORKS MULTI CAMERA BROWSER

VN-S200U/S100U INSTRUCTIONS



For Customer Use:

Enter below the Serial No. which is located on the body. Retain this information for future reference.

Model No. **VN-S200U/S100U**

Serial No. _____

This instruction book is made from 100% recycled paper.

SS961541-001

CAUTION

- It is strictly prohibited to duplicate or copy any part or whole of this document.
- The information in this document is subject to changes without prior notice.
- Bear in mind not to violate the copyright when using either the product or this document.
- We cannot assume any liability for the consequences of any errors or mistakes occurring in this document.

TRADEMARKS

Microsoft and Windows are registered trademarks of the Microsoft Corporation operating both in the United States and in other countries.

This document omits symbols such as TM, ©, ® with trademarks.

Other corporate names and product names mentioned in this document are trademarks or registered trademarks of their respective owners.

BEFORE RECORDING OR SAVING IMAGES

- Copyright law prohibits the use without authorization of the copyright owners of images reproduced from TV broadcasting or video recording and the recording of images of published materials such as posters, except for the purpose of personal entertainment.
- When recording or saving an important image, always be sure to perform test recording in order to ensure correct recording and reproduction. Also take care of the available hard disk capacity.
- We cannot assume any liability for damages which may be incurred in a case where correct recording or reproduction is not available due to a problem with the present application or with the computer software.

CONTENTS

| | | | |
|--|-----------|---|-----------|
| INTRODUCTION | 3 | SNAPSHOT RECORDING | 18 |
| INSTALLATION | 7 | CHANGING THE VIEW WINDOW SETUP ... | 19 |
| VIEWING V.NETWORKS IMAGES | 9 | CHANGING THE V.NETWORKS SETUP ... | 24 |
| CONTROLLING THE V.NETWORKS | 12 | SETTING THE POSITION MEMORY | 25 |
| RECORDING V.NETWORKS IMAGES ... | 14 | ARRANGING THE WINDOWS | 26 |
| DELETING RECORDING FILES | 15 | RIGHT-CLICK MENU | 27 |
| TIMER RECORDING | 16 | UNINSTALLATION | 28 |
| PLAYING RECORDING IMAGES | 17 | TROUBLE SHOOTING | 29 |



INTRODUCTION

This application entitled "MULTI CAMERA BROWSER" (VN-S100U, VN-S200U) is used to display images from multiple V.NETWORKS units on the operator terminal equipment.

(The V.NETWORKS series products include the VN-C1U, VN-C2U and VN-C3U. Verify that your V.NETWORKS unit is the VN-C1U, VN-C2U or VN-C3U.)

Operating Environment

The following environment is required to run this application.

Basic software:

Microsoft Windows 95, 98 or NT (Service Pack 4 or higher)

Computer:

A PC incorporating Pentium II 333 MHz or faster CPU.
(Pentium III 500 MHz or more is recommended.)

Memory

Available memory space of 64 MB or more.
(128 MB or more is recommended.)

Hard disk free capacity (before installation)

10 MB or more (Free space of at least 50 MB is required for recording.)

Disk device

CD-ROM drive is indispensable.

Display, video card

Resolution 640×480 or better. High Color (16-bit) display is indispensable.
(Resolution of 1024×768 or better and True Color (32-bit) display are recommended)

Other

The MULTI CAMERA BROWSER is compatible only with JVC camera models VN-C1U, VN-C2U and VM-C3U.

Main Functions

1. Multi-browsing

- Simultaneous connections to multiple V.NETWORKS units.
- Simultaneous browsing of up to 16 units (With the VN-S100U, up to 4 cameras can be browsed.)

2. Recording

- The displayed V.NETWORKS images can be saved as successive still images.
- Variable saving interval.
- Timer recording. (This function is for exclusive use with the VN-S200U.)

3. PLAY BACK

- Playback of recording by simply specifying the time and date.
- Simultaneous display of saved time.

4. Pop-up

- Ctrl + double clicking on a window showing a V.NETWORKS image, displays a magnified image in another window.

5. Snapshot

- Saving of still images in desired folders (up to 16 images).

6. Auto dial-up

- When a V.NETWORKS unit on WAN is registered, it can be connected by automatic dial-up.

Overall View of MULTI CAMERA BROWSER Screen

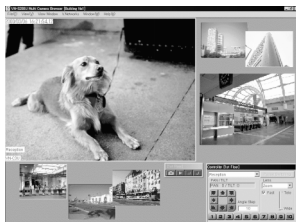

Figure 1

NOTE) Fig. 1 shows the overall view with the VN-S200U.

With the VN-S100U, up to four images can be displayed in the View window.

Menu Function List

| Menu Item | Pull-Down Item | Outline |
|-------------|---------------------|--|
| File | New Work space | Creates a new work space. |
| | Open Work space | Opens an existing work space. |
| | Save Work space | Saves a work space by overwriting. |
| | Save Work space as | Saves a work space by assigning a new name. |
| | Close Work space | Close the currently open work space. |
| | Exit | Exits from the browser. |
| View | Controller | Toggles the display of the V.NETWORKS controller on and off. |
| | REC/Play Controller | Toggles the display of the recording, playback and snapshot controller. |
| | Tool Tip | Toggles the display of the tool tip. |
| View window | New View Window | Creates a new View window. |
| | Add View Window | Opens an existing View window. |
| | Delete View Window | Deletes the registration of a View window. |
| | Start Recording | Saves the images in the View window as successive images. |
| | Stop Recording | Stops recording. |
| | Timer Recording | Starts and stops recording automatically at the set time of day. |
| | Start Playback | Plays the recorded images successively. |
| | Stop Playback | Stops Playback. |
| | Properties | Sets up the View window. |
| V.Networks | Register V.Networks | Registers a V.NETWORKS in the View window. |
| | Delete V.Networks | Deletes a V.NETWORKS from the View window. |
| | Properties... | Sets up a V.NETWORKS. |
| | Position Memory | Sets up the position memory. |
| Window | Arrange view Window | by Registration Arranges windows in a tile in the order they were registered. |
| | | by Name Arranges windows in a tile in the alphabetical order of names |
| | Align With Grid | Aligns the windows with grid automatically. |
| | (Window List) | Checks the View windows being displayed. |
| Help | About | Shows the browser version. |

Construction of MULTI CAMERA BROWSER

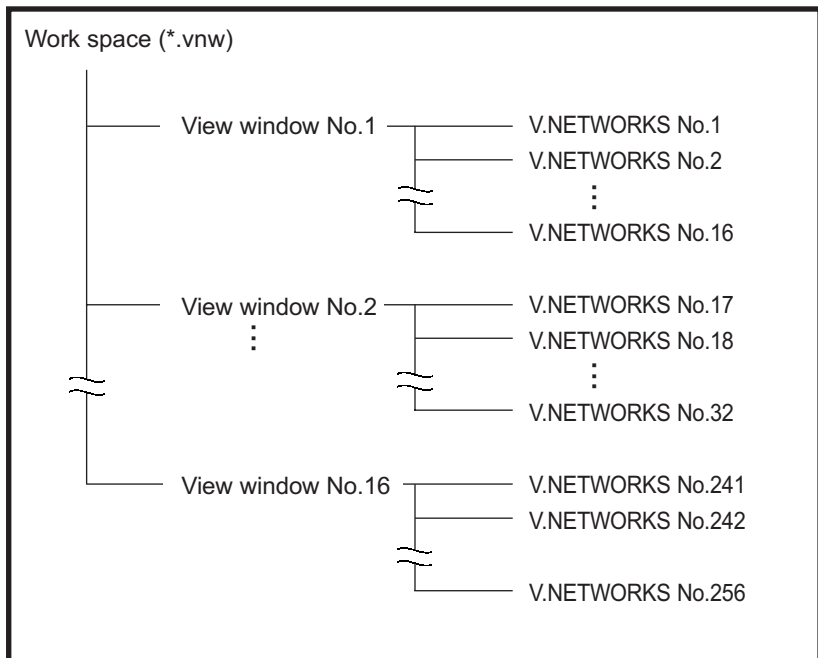

*The figure above shows the construction of the VN-S200U.

With the VN-S100U, the following restrictions are applied.

- Number of View windows 4
- Number of cameras per View windows . . . 4

INSTALLATION

☆ This section describes the installation procedure of the application.

1. Insert the "VN_S200U" CD-ROM in the CD-ROM drive (* with the VN-S200U).
2. Double-click \Jvc\setup.exe of the CD-ROM in order to run it.

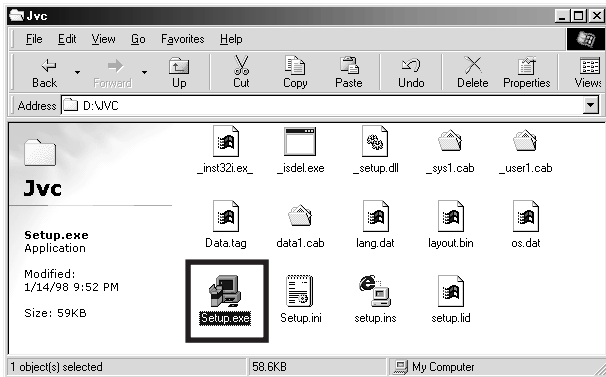

In advance, set the IP addresses of the VN-C1U/C2U/C3U cameras to be used using the provided setup tool. For the operating procedure of the setup tool, refer to the cameras' instruction manuals.

3. Perform operations in accordance with the displayed instructions.

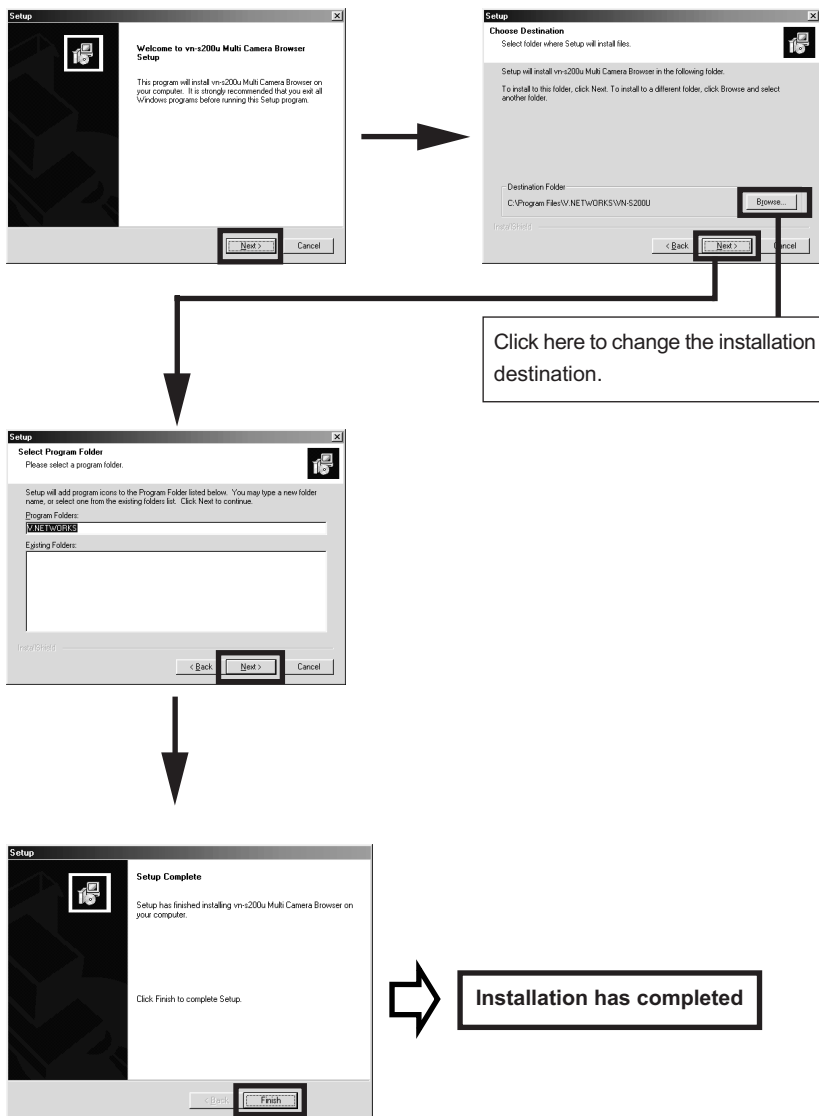



VIEWING V.NETWORKS IMAGES

This section describes the operations procedure for displaying V.NETWORKS images on your PC.

1. Start the Multi Camera Browser.

- 1-1. From "Start" on the taskbar, select [Programs] - [V.NETWORKS] - [vn-s200u Multi Camera Browser] to start it.

2. Create a workspace

- 2-1. On the menu bar, select [File] - [New Workspace] to create a new workspace.

3. Register V.NETWORKS in the workspace

- 3-1. On the menu bar, select [V.Networks] - [Add V.Networks]

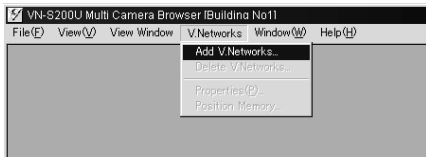

- 3-2. Enter the V.NETWORKS name, IP address, connection mode and connection destination (only when 'WAN' is selected as the connection mode).

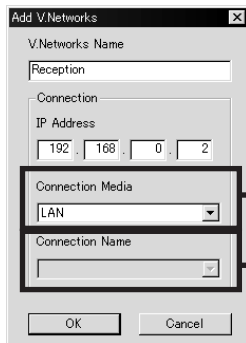

LAN : Connected through LAN
WAN : Dial-up connection

When WAN is used, it is necessary to set the connection destination in advance. For the procedure, refer to the Windows manual and other documents.

4. Create a View window

4-1. On the menu bar, select [View Window] - [New View Window].



4-2. When a window is displayed, enter the View window name in it.



4-3. On the "View Window Setup" item, select the View window where you want to add the V.NETWORKS and click the <Add> button.

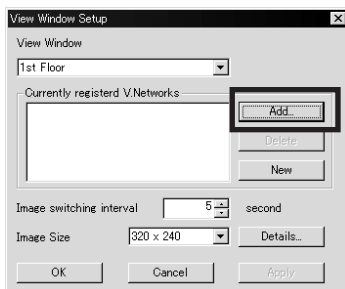

4-4. When the "Add V.Networks" window is displayed, click the displayed contents in order to display all the V.NETWORKS units registered for the workspace. Select the V.NETWORKS to be added to the View window and click the <OK> button.



- 4-5. Set the View window switching interval and image size, then click the <OK> button.





CONTROLLING THE V.NETWORKS

This section describes how to pan, tilt or zoom the connected V.NETWORKS using the controller and set it to the condition in which viewing is required.

Procedure

1. Among the currently displayed View windows, click the one where the V.NETWORKS to be controlled is registered in order to make it active.
2. If more than one V.NETWORKS has been registered in the View window, interrupt the image switching by clicking the [Pause Switching] button on the controller.
3. Click the pull-down menu of the controller to select the V.NETWORKS to be controlled.

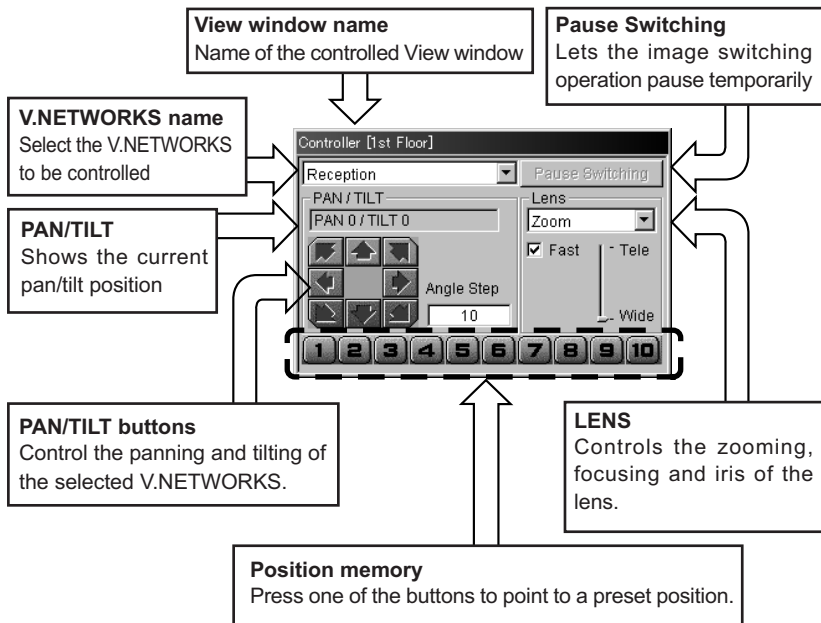

When the connection destination is the VN-C1U : Pan/tilt/zoom/position memory operations are not available.

When the connection destination is the VN-C2U : Zooming operation and position memories 7 to 10 are not available.

Operations

Panning/tilting operation

Click one of the eight arrow buttons to pan/tilt the V.NETWORKS in the indicated direction by the angle set in "Angle Step". (The angle is freely variable in steps between 0° and 40°.)

Lens operation

In the pull-down menu in the LENS field, select the item to be controlled from IRIS, ZOOM and FOCUS.

- When the Zoom operation is selected, the "Fast" check-box is displayed. Checking this box enables zooming in and out at high speed.
- When the Focus operation is selected, the "Auto" check-box is displayed, Checking this box enables auto focusing.
- When the Iris operation is selected, the "Auto" check-box is displayed. Checking this box enables auto iris control.



RECORDING V.NETWORKS IMAGES

- The recording function saves images displayed in the currently active window onto a disk.
- Images are recorded on a per-window basis. The recording file is stored in the folder specified by "Save in" under [View Window] - [Properties] - [Details]. The default folder is the folder having the same name as the View window name under the folder where the application is installed {i.e. (Application installation folder)\(View window name)}.
- When recording has completed, a file named *****.rec is created on a disk.
- For detailed recording setup, see "5. Recording setup" in "CHANGING THE VIEW WINDOW SETUP".

Procedure

1. Among the currently displayed View windows, click the View window to be recorded to make it active.
2. Ensure that the title bar of the Record/Play Controller shows the name of the View window to be recorded, then click the Record button. (If the Record/Play Controller is not displayed, select [View] - [REC/Play Controller] to display it.)



3. Recording starts at the same time as the characters "REC" are displayed on the top right of the View window.



DELETING RECORDING FILES

- Recording files are saved with file names "<recording start time>.rec".
- To delete recording files, open the Explorer and delete files "*.rec".

CAUTION !!

As a recording file cannot be restored once it has been deleted, make sure that the file is unnecessary by checking the contents before deletion. JVC cannot assume liabilities for the loss of recording files.



TIMER RECORDING

(*This function is for exclusive use with the VN-S200U.)

- The timer recording function starts and stops recording automatically at the set time of day.
- For detailed recording setup, see "5. Recording setup" in "CHANGING THE VIEW WINDOW SETUP".

Procedure

1. Select [View Window] - [Timer Recording].
2. The [Timer Recording] window appears.
3. In the View window column, select the View window you want to set timer recording.



4. To set timer recording, check the [Enable Timer Recording] check box and set the [Recording start time] and [Recording end time].



5. After checking that the set data is correct, click <OK>.

CAUTION !!

To enable timer recording, the MULTI CAMERA BROWSER (this application) should be running at the timer start time.



PLAYING RECORDING IMAGES

(*VN-S100U : 1 image play back, VN-S200U : up to 4 images play back simultaneously.)

- This section describes how to play back a recorded file.

Procedure

1. Click the Play button of the Record/Play Controller. When a window as shown below appears, select the size and number of played windows.

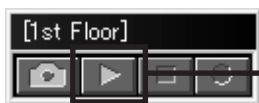

2. When the Select Image window appears, select the View window to be played and the time.
(When the [Sort by Name] check box is checked, the time is sorted on a per-camera basis.)
(Click [Browse] allows you to select another folder.)

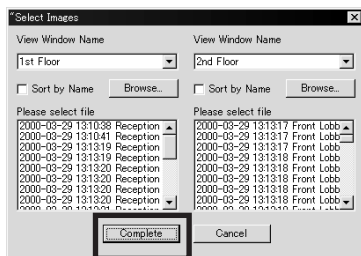

Select View window

Select time

* 2 Screen during playback

3. Click [Complete] to display the Playback window.



SNAPSHOT RECORDING

- The snapshot function saves the currently displayed View window as a still image in a file.
- Up to 16 images can be acquired at once.

Procedure

1. Click the View window where the images that you want to include as snapshots are displayed.
2. Click the Snapshot button of the Record/Play Controller. If the Record/Play Controller is not displayed, select [View] - [REC/Play Controller] to display it.
*A check mark is displayed to the right of "REC/Play Controller" while the Record/Play Controller is displayed.

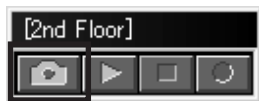

3. Click the Snapshot button to display the still image of the currently active View window in another window (Snapshot window).
4. In the Snapshot window, select [File] - [Save]. The [Save] dialog box appears and the still image can be saved in a desired disk.

CAUTION !!

The saved snapshot files cannot be viewed with the MULTI CAMERA BROWSER appropriate image viewing software.



CHANGING THE VIEW WINDOW SETUP

1. Adding or deleting V.NETWORKS to or from a View windows

- 1-1. When [View Window] - [Properties] in the menu bar is selected, the following window appears. Use this window to change the setup of the View window.

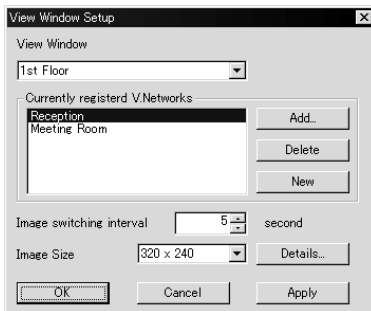

- 1-2. Select the View window you want to change the setting.



- 1-3. The list of currently registered V.NETWORKS names is shown under item [Currently Registered V.Networks].

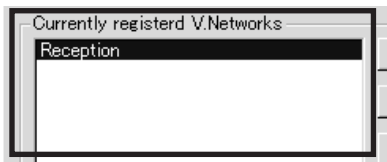

- ➔ To add V.NETWORKS, go to step 1-4
- ➔ To delete V.NETWORKS, go to step 1-5

- 1-4. Click the [Add] button. When the [Add V.Networks] window appears showing the list of V.NETWORKS currently registered in the workspaces select the V.NETWORKS you want to add and click the [Add] button. The addition is complete when the name of the added V.NETWORKS is displayed in the [Currently registered V.Networks] field.

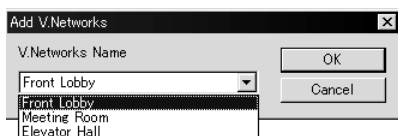

*Up to 16 V.NETWORKS units can be registered per View window. It is not permitted to register more than 16 V.NETWORKS.

- 1-5. In the [Currently registered V.Networks] field, select and highlight the V.NETWORKS to be deleted and click the [Delete] button. The deletion is completed when the name of the specified V.NETWORKS disappears from the [Currently registered V.Networks] field.

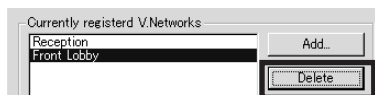

2. Changing the image switching interval

When more than one V.NETWORKS is registered in a single View window, this function sets the interval of switching the images of different V.NETWORKS in seconds. If it is not required to switch V.NETWORKS, click the mouse right button and on the view window use [Pause Switching].

3. Changing the window size

This function changes the size of the View window.

Select the window size from three options of 160×120, 320×240 and 640×480.

REMARK : If the view window size is increased more than the camera image size, the image quality becomes coarse due to image magnification.

4. Setting the information display

This function displays information on the currently displayed V.NETWORKS.

1. Display no information.
2. Display the V.NETWORKS name.
3. Display the V.NETWORKS name and V.NETWORKS ID.
4. Display the V.NETWORKS name, V.NETWORKS ID and model name.

Select one of the four options above (also see the figure on the right).

(The information is displayed in the same color as the color set for the Time Stamp.)

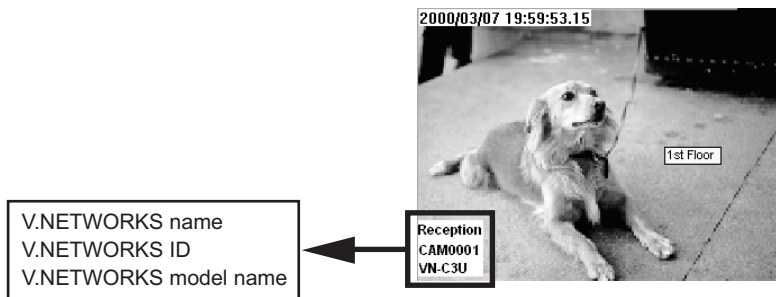

Time stamp : Displays the current time of day in the View window.

Status : Displays the name, ID and model name of V.NETWORKS.

The display or non-display as well as the display style can be set.

The settings can be confirmed in the preview.

Color : Sets the color of characters and the backgrounds of information.

5. Recording setup

This function will change the settings related to recording. The settings made here are also reflected in timer recording.

[Recording Method]

- Sets the recording method for the available capacity in the save destination disk.

Update : When the available space decreases, old images recorded at the beginning of the recording are deleted in order to save the latest images.

Stop : Recording stops when the available space decreases.

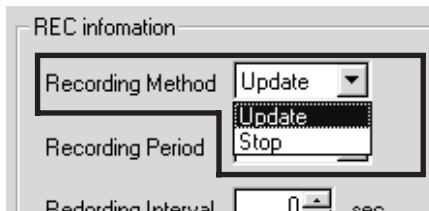

[Recording Period]

- Specifies the time after the start till the end of recording.

Select from : 5 min., 10 min., 20 min., 30 min., 40 min., 50 min., 1 hr, 2 hr, 3 hr, 6 hr, 12 hr., 1 day, 2 days, 3 days, 4 days, 5 days, 6 days, 1 week, No limit.

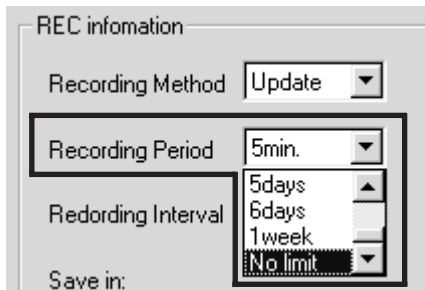

[Recording Interval]

- Specifies the interval of recording of each frame in seconds.
Set in the range from 0 to 120 seconds.

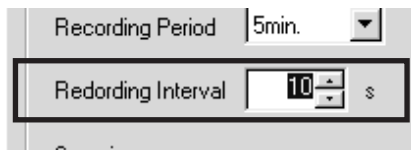

[Save in]

- Sets the folder where you want to save the recording file.
- Can be set for each View window.

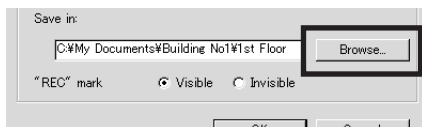

[REC mark]

- Displays characters "REC" at the top right of the View window during recording.

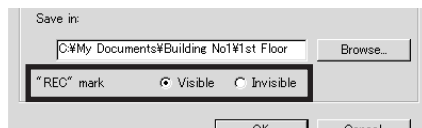



CHANGING THE V.NETWORKS SETUP

Details of V.NETWORKS including the image quality can be set.

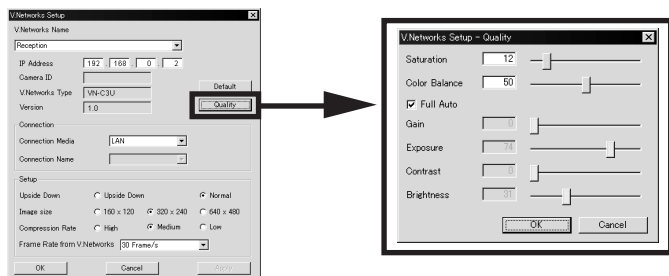

[Quality]

- | | | |
|--|---------------|-------------------------------------|
| | Saturation | Adjusts the depths of colors |
| | Color Balance | Adjust the balance of blue and red. |
| *These do not need adjustment in the Full Auto operation | Gain | Adjusts the sensitivity |
| | Exposure | Adjusts the iris |
| | Contrast | Adjusts the contrast |
| | Brightness | Adjusts the brightness |
- *Exposure cannot be controlled when the VN-C3U is connected.

[Upside down]

- Displays the V.NETWORKS images upside down.
(Perform settings according to the circumstances of the camera installation.)

[Image size]

- Sets the sizes of the images sent from V.NETWORKS.
Select the desired size from 160×120, 320×240 and 640×480.

[Frame Rate]

- Sets the maximum frame rate of image transmission by V.NETWORKS.
Set a rate in the range from 30 Frame/sec. to 1 Frame/sec.

*In this context, the frame rate refers to the transmission frame rate of the V.NETWORKS unit. The image display rate shown on the PC is variable depending on the PC performance and the LAN environment.



SETTING THE POSITION MEMORY

- This function changes the setting of the position memory for panning, tilting(VN-C2U • VN-C3U) and zooming (VN-C3U only).

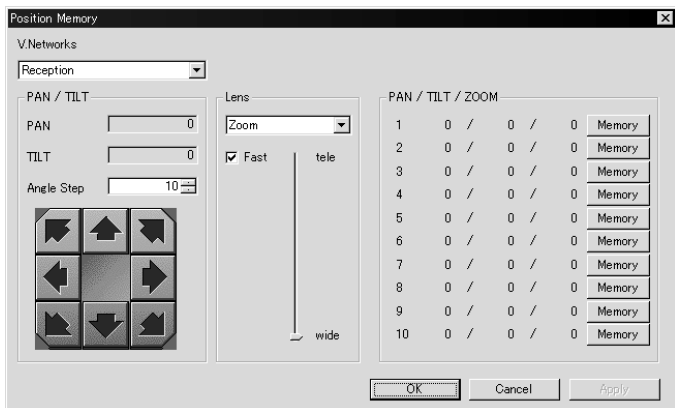

Procedure

1. In the menu bar, click [V.Networks] - [Position Memory].
2. Select the V.NETWORKS for which you want to change the position memory.
 - * The current registration information is displayed in the [PAN/TILT/ZOOM] field.
3. Operate the panning, tilting and zooming to set the conditions you want to register.
4. In the position memory bank from 1 to 6 (from 1 to 10 with the VN-C3U), click the [Memory] button with the memory number you want to use. Now the position memory setting is complete.



ARRANGING THE WINDOWS

● Arrange Windows

- Arranges the View windows.

(Arranging is sometimes not possible depending on the numbers and sizes of the windows.)

● Align with Grid

- Arranges the View windows by automatically aligning them with the grid.

● Window List

- Display all the View windows registered in the workspaces.
- A check mark is shown to the left of the currently displayed window.
- Placing a check mark causes the corresponding View window to be displayed, and removing it causes the View window to disappear.

View Window

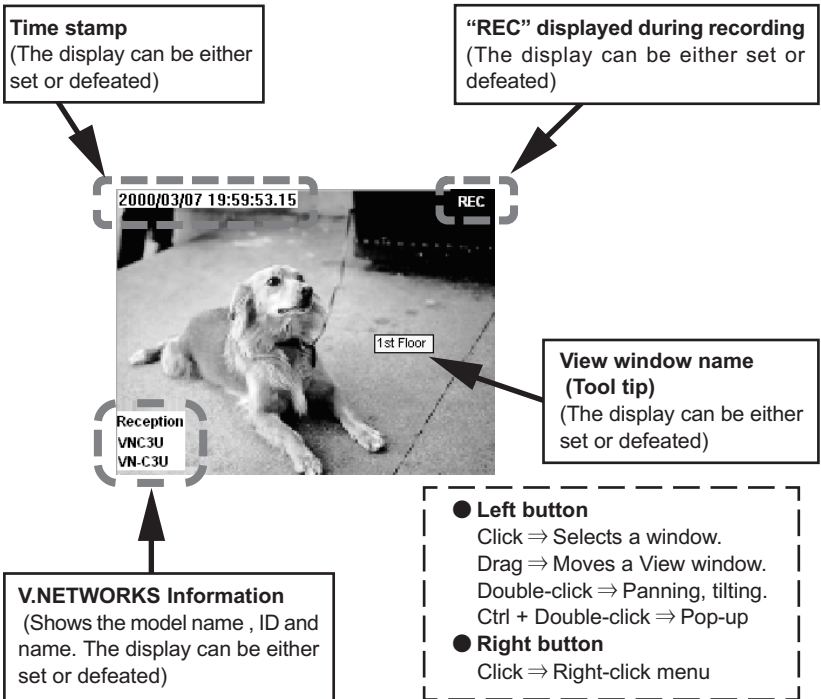



RIGHT-CLICK MENU

Clicking the right button of the mouse on the View window displays the right-click menu as shown below. The right-click menu can be used to control the following functions.

- **Tele**
 - Zooms into an image.(VN-C3U only)
- **Wide**
 - Zooms out from an image.(VN-C3U only)
- **Larger**
 - Magnifies image without changing the resolution.Image size changes from 160×120 to 320×240 and 640×480. (The size of the images transmitted by each V.NETWORKS is not affected.)
- **Smaller**
 - Reduces image size without changing the resolution.
 - Image size changes from 640×480 to 320×240 and 160×120. (The size of the images transmitted by each V.NETWORKS is not affected.)
- **Pause Switching**
 - Lets the image switching of V.NETWORKS pause temporarily.
- **Show Time Stamp**
 - Displays the current time of day on the View window screen.
- **Properties**
 - Displays the [View Window setup] window.
(* For details on the View window, see "CHANGING THE VIEW WINDOW SETUP" on page 19.)

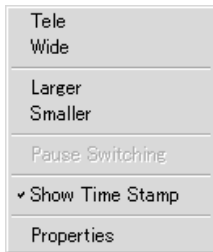

Right-click menu



UNINSTALLATION (Procedure for Windows98)

Use the following procedure to uninstall (Delete) the Multi Camera Browser from your PC.

1. In the taskbar, select [Start] - [Settings] - [Control Panel]

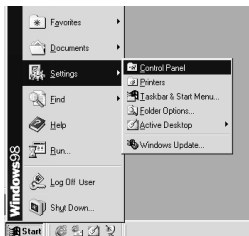

2. In the Control Panel, double-click "Add/Remove programs".



3. When the [Add/Remove programs Property] window appears, select "vn-s200u Multi Camera Browser" under the [Install/Uninstall] tag and click the [Add/Remove] button.



The recording files (including the folders having the View window names) and the Multi Camera Browser workspace setting file (*.vnw) are not deleted by uninstalling.



TROUBLE SHOOTING

| | |
|---|---|
| <p>You have forgotten the IP address of V.NETWORKS that has been changed using the V.NETWORKS setup tool.</p> | <p>The list of the IP addresses of the V.NETWORKS cameras connected to the network can be acquired using the [Search] button of the V.NETWORKS setup tool provided with the VN-C1U/C2U/C3U. The history of modifications with the V.NETWORKS setup tool is stored in file "Vnetst.log" in the root directory using the following format.</p> <p style="padding-left: 40px;">IP before change, ID after change IP before change, ID after change Date & time (Day/Month/Year/Hour: Minute)</p> <p>If the IP address cannot be identified referring to the Vnetst.log, it should be treated as a repair item. Please consult your dealer.</p> |
| <p>You have forgotten the password set with the password protect function.</p> | <p>Cancellation of password protection is handled as a repair item. Please consult your dealer. For security, your dealer may request you to present your personal ID card.</p> |
| <p>The image size or position changes spontaneously.</p> | <p>When a single V.NETWORKS unit is connected to more than one PC, the PC, which last controlled or set the V.NETWORKS is given precedence.</p> <p style="text-align: right;">(To the next page)</p> |

| | |
|-----------------------------------|---|
| <p>The colors look unnatural.</p> | <ul style="list-style-type: none"> • Check the color adjustments of the display and video card. <p>The hues of displayed colors may be variable depending on the video card and monitor display of the PC system. This may sometimes be corrected by adjusting the color control of the display. With some video cards, color adjustment is available in "Screen Properties" (which can be displayed by right-clicking the mouse on the desktop).</p> <ul style="list-style-type: none"> • Set the True Color (24-bit) display. <p>It is difficult to reproduce natural hues with High Color (16-bit) or lower-quality settings. We recommend the use of the True Color setting.</p> <ul style="list-style-type: none"> • Adjust the color balance. <p>The hues may be corrected with W/B Blue and Red controls in the Set Image Quality menu.</p> <ul style="list-style-type: none"> • Turn Full Auto off then on again. <p>When recording scenes with different light sources (for example when recording outdoors under sunlight and indoors under fluorescent light alternately), it takes some time before the auto-tracking white balance control is activated. In such a case, remove the check mark of Full Auto in the Set Image Quality menu and check it again. This speeds up the time before the white balance control is activated.</p> <p>The image size or position changes spontaneously. When a single V.NETWORKS unit is connected to more than one PC, the PC, which last controlled or set the V.NETWORKS is given precedence.</p> |
|-----------------------------------|---|

MEMO

JVC

VICTOR COMPANY OF JAPAN, LIMITED